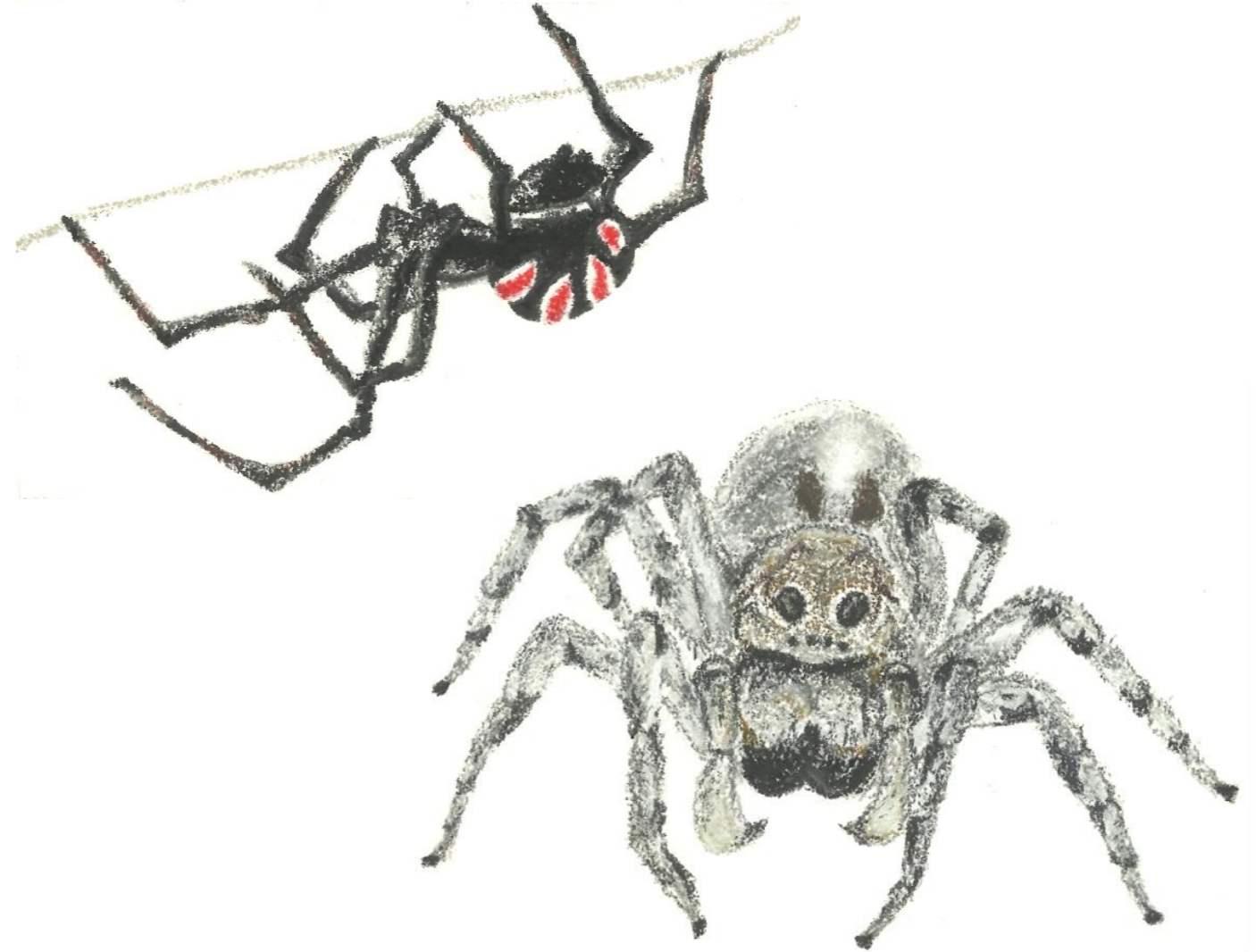


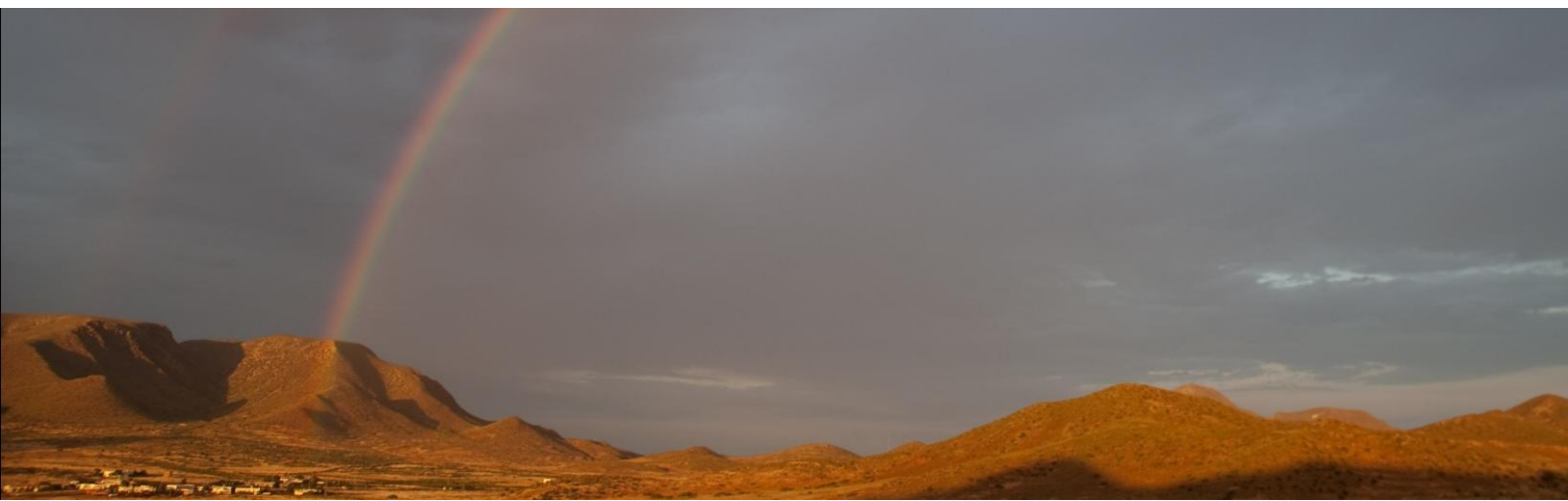
**IMPLICACIONES DE LA CAPACIDAD DE  
MOVIMIENTO EN LAS ARAÑAS (ARANEAE)  
PARA LA EVOLUCIÓN ADAPTATIVA DEL TAMAÑO  
Y LA FORMA SEGÚN EL SEXO, HÁBITAT  
Y MODO DE VIDA**



Departamento de Ecología Funcional y Evolutiva  
Estación Experimental de Zonas Áridas  
CONSEJO SUPERIOR DE INVESTIGACIONES CIENTÍFICAS

Departamento de Ecología  
Facultad de Ciencias  
UNIVERSIDAD DE GRANADA

**M. GUADALUPE CORCOBADO MÁRQUEZ  
TESIS DOCTORAL 2011**







# **Implicaciones de la capacidad de movimiento en las arañas (Araneae) para la evolución adaptativa del tamaño y la forma según el sexo, hábitat y modo de vida**

## **TESIS DOCTORAL**

M. Guadalupe Corcobado Márquez

Granada, 2011



Departamento de Ecología Funcional y Evolutiva  
**Estación Experimental de Zonas Áridas**  
CONSEJO SUPERIOR DE INVESTIGACIONES CIENTÍFICAS



Departamento de Ecología  
**Facultad de Ciencias**  
UNIVERSIDAD DE GRANADA

Editor: Editorial de la Universidad de Granada  
Autor: M. Guadalupe Corcobado Márquez  
D.L.: GR 634-2012  
ISBN: 978-84-694-6015-3

M. Guadalupe Corcobado Márquez  
Estación Experimental de Zonas Áridas  
Consejo Superior de Investigaciones Científicas  
Carretera de Sacramento, s/n, Cañada de San Urbano  
E-04120, Almería, Spain

[gcorcobado@gmail.com](mailto:gcorcobado@gmail.com)

Los dibujos de la portada son obra de **Mercedes Corcobado Márquez**

Imagen de la página 77 ha sido cedida por Dennis Kuntel. Derechos de autor: **Dennis Kunkel Microscopy, Inc.** ([www.denniskunkel.com](http://www.denniskunkel.com)).

Las fotos de las páginas 53, 97, 163 y la contraportada han sido tomadas y cedidas por **Eva de Mas**.

**Este trabajo ha sido financiado por una beca de Formación de Personal Investigador (FPI, ref: BES-2005-9234) y dos proyectos del Ministerio de Ciencia e Innovación/FEDER (CGL2004-03153 and CGL2007-60520)**

**Implicaciones de la capacidad de movimiento  
en las arañas (Araneae) para la evolución  
adaptativa del tamaño y la forma según el sexo,  
hábitat y modo de vida**

**Memoria presentada por M. Guadalupe Corcobado Márquez para optar al  
Grado de Doctora por la Universidad de Granada**

La Doctoranda

A handwritten signature in blue ink, appearing to be 'G. Corcobado', written over a large, light blue diagonal stroke that spans across the signature.

**M. Guadalupe Corcobado Márquez  
Granada, mayo2011**





**Dr. Jordi Moya-Laraño**, Científico Titular de la Estación Experimental de Zonas Áridas-CSIC y el **Dr. Miguel Ángel Rodríguez-Gironés Arbolí**, Científico Titular de la Estación Experimental de Zonas Áridas-CSIC

CERTIFICAN

Que los trabajos de investigación realizados en la Memoria de Tesis Doctoral: **“Implicaciones de la capacidad de movimiento en las arañas (Araneae) para la evolución adaptativa del tamaño y la forma según el sexo, hábitat y modo de vida”**, son aptos para ser presentados por la **Lda. M. Guadalupe Corcobado Márquez** ante el Tribunal que en su día se designe, para aspirar al Grado de Doctora en Ciencias Biológicas por la Universidad de Granada.

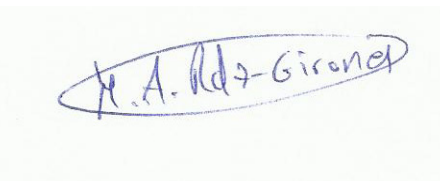
Y para que así conste, en cumplimiento de las disposiciones vigentes extendemos el presente certificado a 16 de mayo de 2011 en Almería.

VºBº Director



**Dr. Jordi Moya-Laraño**

VºBº Director



**Dr. Miguel Ángel Rodríguez-Gironés Arbolí**



*A mis padres Genaro y Carmen,  
y a mis tres hermanas Mari, Conchi y Merce,  
como recompensa por todo el tiempo  
que esta tesis les ha robado.*

*Desde hace tiempo, intento  
cambiar cantidad por calidad  
en el tiempo que compartimos*

*A Miguel,  
por su infinita paciencia,  
y por poner su energía cuando la mía se agotaba*



*La ignorancia afirma o niega rotundamente; la ciencia duda.*

*Voltaire (1694-1778) Filósofo y escritor francés.*



## Índice

ÍNDICE.....	1
RESUMEN.....	3
INTRODUCCIÓN GENERAL.....	11
Introducción.....	13
Las arañas como sistema de estudio.....	25
Justificación y Objetivos.....	28
Bibliografía.....	36
MANSUCRITOS.....	51
Manuscrito I: Morphological evolution of spiders predicted by pendulum mechanics.....	53
Manuscrito II: Silk elasticity as a potential constraint on spider body size..	77
Manuscrito III: Introducing the refined gravity hypothesis of extreme sexual size dimorphism.....	97
Manuscrito IV: Sociality level explains dispersal ability in spiders.....	135
Manuscrito V: Sprint vs cruise speed: Implications for natural and sexual selection.....	163
Manuscrito VI: Scramble competition by male long-distance mobility in a burrowing wolf spider.....	187
DISCUSIÓN INTETRADORA.....	221
Resultados y Discusión.....	223
Bibliografía.....	235
CONCLUSIONES / CONCLUSIONS.....	241
Conclusiones.....	243
Conclusions.....	245
AGRADECIMIENTOS.....	247





# RESUMEN



## Resumen

La habilidad de un organismo para moverse desempeña un papel fundamental en muchas de las actividades que debe realizar para cumplir sus funciones vitales. De este modo, podemos decir que la capacidad de movimiento puede incrementar la eficacia biológica de un individuo vía selección natural, aumentando la supervivencia y/o fecundidad de los organismos, o vía selección sexual, incrementando su éxito a la hora de obtener pareja. Cabría esperar, por tanto, que a lo largo de la evolución se hayan seleccionado tamaños y formas adaptadas a maximizar la capacidad de movimiento dependiendo del modo de vida de los organismos. Así, en taxones donde ambos sexos adoptan distinto modo de vida una vez alcanzado el estado adulto, como es el caso de muchas especies de arañas, la importancia de desarrollar morfologías adaptadas al movimiento va a depender del rol sexual y va a variar entre machos y hembras, originando patrones de dimorfismo sexual. En particular, los desplazamientos suelen aumentar la tasa de depredación. Como los costes del desplazamiento van a condicionar la elección entre dispersión y filopatría a la que los individuos deben enfrentarse, se deduce que la capacidad de locomoción de un individuo debe influir en su tendencia a la dispersión.

La mayoría de los estudios muestran una estrecha relación entre tamaño y/o forma y capacidad de locomoción, aunque la mayoría de los trabajos han utilizado la velocidad de escape como índice de capacidad de locomoción, mientras que otros aspectos tales como velocidad de crucero apenas han sido investigados. Además, existe un número considerable de trabajos que han analizado cómo la capacidad de movimiento se relaciona con la supervivencia (selección natural), mientras que el papel de las habilidades locomotoras de los organismos sobre su éxito reproductivo (selección sexual) se ha estudiado mucho más raramente. Por último, existen modos de locomoción exclusivos de algunos grupos taxonómicos, como es el puenteo en las arañas –un tipo de locomoción aérea mediado por seda muy común en arañas que viven en la vegetación–, que han sido totalmente obviados en los estudio de ecología

evolutiva. Todo ello a pesar de estar probablemente muy extendidos y de desempeñar por tanto un papel fundamental en la evolución de los rasgos de las especies que los emplean.

A la vista de los antecedentes expuestos anteriormente, a lo largo de esta tesis se han estudiado algunas de las implicaciones ecológicas y/o evolutivas de la capacidad de movimiento, relacionadas tanto con la selección natural como con la selección sexual. En particular, en este trabajo se evalúan implicaciones de la capacidad de movimiento en la selección de las morfologías más adecuadas dependientes del tipo de hábitat o modo de vida, la evolución del dimorfismo sexual en el tamaño (SSD, del inglés *Sexual Size Dimorphism*), la selección sexual por orden de llegada y la evolución de la sociabilidad en arañas.

En el *manuscrito I* de esta tesis, a través de un estudio comparativo que incluyó una muestra de amplia diversidad filogenética y un amplio rango de tamaños, se estudió si la forma de las arañas podría haber evolucionado de acuerdo a las predicciones de la mecánica pendular, teniendo en cuenta que, desde un punto de vista biomecánico, el puenteo podría ser análogo al movimiento de un péndulo, mientras que andar sobre una superficie horizontal podría ser análogo al movimiento de un péndulo invertido. Se encontraron varias líneas de evidencia a favor de esta hipótesis. En primer lugar, de acuerdo con las predicciones de la mecánica pendular, las arañas que viven colgadas por sus patas tienen patas relativamente más largas que aquellas especies que viven en el suelo y habitualmente se desplazan soportando el peso del cuerpo sobre sus patas. Además, tener patas de mayor longitud permite a las arañas moverse a mayor velocidad durante el puenteo, mientras que estas mismas arañas corren sobre el suelo a velocidades relativamente menores. Por último, cuando estas arañas eran inducidas a correr sobre superficies horizontales se movían más lentamente que otras especies de similar tamaño pero que habitualmente se desplazan corriendo sobre el suelo y tienen por ello patas de menor longitud.

En el *manuscrito II* de esta tesis desarrollamos un modelo biomecánico para investigar si las propiedades mecánicas de la seda (elasticidad y resistencia a la rotura) podían restringir el tamaño máximo a partir del cual el puenteo deja de ser un mecanismo de dispersión eficiente. Los resultados encontrados verificaron esta

hipótesis, dado que se encontró que el diámetro mínimo de seda requerido para puentear de forma eficiente crece con la raíz cuadrada del peso de la araña, a una mayor tasa que el diámetro de la seda producida realmente por las glándulas del tipo “minor ampullate” –glándulas que producen el tipo de seda usada para puentear– dando lugar a un umbral de peso a partir del cual el puenteo deja de ser eficiente.

En el *manuscrito III* de esta tesis introducimos una nueva hipótesis que podría explicar la evolución del SSD, la hipótesis del puenteo-gravedad (en inglés *bridging-gravity hypothesis*), basada en una selección para mantener un tamaño pequeño en los machos –sexo encargado de buscar pareja en la mayoría de las especies de araña– adecuado para puentear de forma eficiente, lo cual les supondría una ventaja en la búsqueda de pareja. Los resultados encontrados apoyaron esta hipótesis. Utilizando datos de machos y hembras de 13 especies de arañas pertenecientes a los dos clados que incluyen la mayoría de los casos de SSD extremo en arañas y aplicando el método comparativo, se encontró que el patrón de SSD explicó de forma significativa la variación en la tendencia a puentear entre machos y hembras, y que tanto la masa como el tamaño explicaron la tendencia a puentear en ambos sexos. Esta nueva hipótesis es compatible con otras propuestas con anterioridad como la hipótesis de la fecundidad, el modelo de mortalidad diferencial o la hipótesis de la gravedad. Sin embargo, esta nueva hipótesis tiene un poder explicativo mayor, dado que explica incluso las excepciones de especies con hembras gigantes que viven en hábitats elevados donde no se encuentra un patrón de SSD, dado que estas especies pertenecen a grupos taxonómicos en los que el mecanismo de dispersión mediante puenteo no ha evolucionado.

En el *manuscrito IV* de esta tesis se analizó cómo la tendencia a puentear –un modo de locomoción habitualmente utilizado en la dispersión pre-apareamiento– así como la habilidad para puentear, cambiaba a lo largo de un gradiente de sociabilidad en arañas. Utilizando 7 especies del género *Anelosimus* con diferentes grados de sociabilidad se encontró que la tendencia a dispersarse mediante puenteo, así como la habilidad para puentear, al menos en machos, disminuían de forma continua al aumentar el nivel de sociabilidad. Además los resultados señalan que un acortamiento en la longitud relativa de la pata, que haría el puenteo menos eficiente,

podría ser el mecanismo por el cual se produce la pérdida de habilidad para dispersarse mediante puenteo asociada a la evolución de la sociabilidad. La pérdida de habilidad para dispersarse en las arañas más sociales incrementaría los costes asociados a la dispersión, pudiendo actuar como un *feedback* positivo que en último término contribuiría al mantenimiento del máximo nivel de sociabilidad, una vez que éste es alcanzado.

En el *manuscrito V* de esta tesis se midió la velocidad de cruceo y la velocidad de escape en cercados conteniendo machos de *Lycosa tarantula* (Lycosidae). Destaca el hecho de que se encontró que la velocidad de cruceo y la de escape no estaban correlacionadas, lo cual implica que los resultados obtenidos a partir de datos de velocidad de escape sólo pueden interpretarse en el contexto de escapar de los depredadores –es decir, selección natural– pero no son válidos en otros contextos como el de la búsqueda de pareja –es decir, selección sexual–. En contra de las predicciones de la mecánica pendular, la condición corporal se relacionó positiva y significativamente tanto con la velocidad de cruceo como con la velocidad de escape. Dado que en esta población de *L. tarantula* las hembras se aparean preferentemente con los machos en mejor condición, y matan y consumen a los machos en peor condición, proponemos que la condición corporal podría actuar como un *handicap*, permitiendo a las hembras seleccionar los machos de mejor calidad para aparearse; es decir, aquellos machos que maduren en mejor condición, puesto que serían los únicos suficientemente fuertes como para soportar una carga extra de peso sin sufrir una reducción en la movilidad.

En el *manuscrito VI* de esta tesis se realizó un experimento para estudiar la competencia por orden de llegada en la tarántula mediterránea (*L. tarantula*), una especie que en condiciones naturales exhibe moderado SSD sesgado hacia las hembras. Se midió la movilidad de los machos usando la técnica de captura-recaptura y se evaluó la selección sexual durante la búsqueda de pareja por medio de gradientes de selección sobre el tamaño, la condición corporal y la movilidad. Hubo una relación positiva entre condición corporal y velocidad promedio, resultado que está de acuerdo con la idea propuesta en el manuscrito anterior de esta tesis de la condición corporal actuando como un *handicap* dependiente de la calidad. Los gradientes de selección lineares evidenciaron selección direccional

sobre condición corporal y movilidad, siendo la selección sobre la movilidad mucho más fuerte que sobre la condición.

En conjunto, los resultados de la presente tesis resaltan el importante papel de la capacidad de locomoción de los organismos en el desarrollo de sus funciones vitales, y por tanto en su eficacia biológica. Así por ejemplo, en esta tesis se pone de manifiesto cómo la adaptación a puentear de forma eficiente puede explicar la evolución adaptativa de la forma y el tamaño de las arañas que pasan su vida colgadas de sus telas, y consiguientemente la evolución del SSD extremo, resultado de distintas presiones de selección actuando en machos y hembras. Otro de los resultados más novedosos de esta tesis es la pérdida progresiva de habilidad para puentear asociada a la evolución de la sociabilidad, que a su vez podría actuar como un *feedback* positivo manteniendo el máximo nivel de sociabilidad una vez que éste se alcanza. Adicionalmente, los resultados de este trabajo señalan la importancia de evaluar la competencia por orden de llegada en la naturaleza –que a menudo ha sido infravalorada en los estudios de selección sexual–, dado que puede desempeñar un papel relevante no sólo en especies con un patrón de SSD extremo tal como se había propuesto hasta la fecha, sino que también en especies caracterizadas por un SSD moderado, tales como la tarántula mediterránea estudiada en esta tesis. Dado que, como se ha puesto de manifiesto aquí, la capacidad de locomoción puede tener implicaciones ecológicas y evolutivas importantes, más allá de lo que se ha considerado hasta la fecha, en el futuro debería prestarse más atención a este rasgo, el cual se halla sujeto a las presiones tanto de la selección natural como de la selección sexual.





# INTRODUCCIÓN

# GENERAL



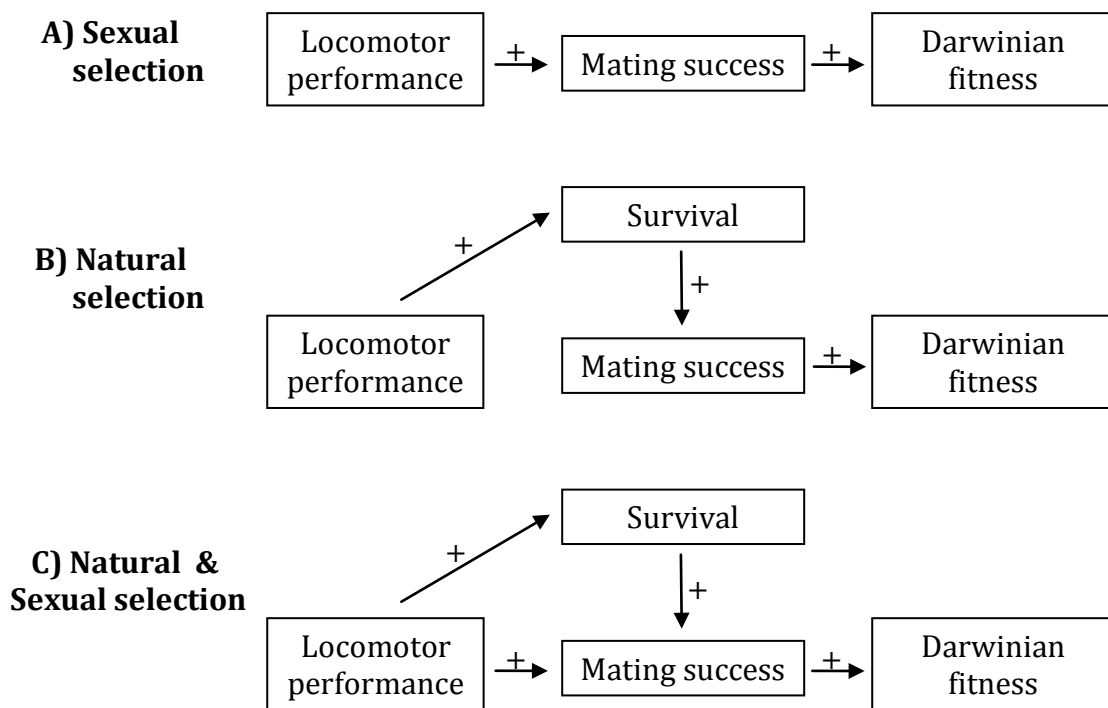
## Introducción

### IMPORTANCIA DE LA CAPACIDAD DE MOVIMIENTO (“*LOCOMOTOR PERFORMANCE*” EN INGLÉS)

La habilidad de un organismo para moverse desempeña un papel fundamental en muchas de las actividades que debe realizar para cumplir sus funciones vitales (Alexander 2003). Ejemplos de procesos donde los individuos ven condicionado su éxito reproductor a su capacidad de movimiento son la búsqueda de alimento (Enders 1976; Torres-Contreras & Vasquez 2007), la dispersión desde los lugares de nacimiento (revisado en Johnson & Gaines 1990), la capacidad para evitar y/o huir de los depredadores (Losos et al. 2002; Pruitt & Troupe 2010), la defensa de un recurso –ya sea un territorio o una pareja– (Husak et al. 2006; Husak et al. 2008), o la búsqueda de pareja (Hanks et al. 1996; Moya-Laraño et al. 2002a; Moya-Laraño et al. 2007a; Kelly et al. 2008). Así, podemos decir que la capacidad de movimiento puede incrementar la eficacia biológica de un individuo vía selección natural, aumentando la supervivencia y/o éxito reproductor de los organismos, o vía selección sexual, incrementando su éxito reproductor. El esquema diseñado por Husak & Fox (Husak & Fox 2008) representa las distintas hipótesis que pueden dar como resultado la existencia de una relación significativa entre capacidad de movimiento y éxito reproductor mediado bien por selección natural, selección sexual, o la interacción de ambos procesos evolutivos (Fig. 1).

Cabría esperar, por tanto, que a lo largo de la evolución se hayan seleccionado tamaños y morfologías óptimas adaptadas a maximizar la capacidad de movimiento en cada tipo de hábitat. De hecho, numerosos estudios han intentado profundizar en el análisis de la triple relación entre morfología, rendimiento (en inglés *performance*) y eficacia biológica, especialmente a partir de que Arnold en 1983 propusiera una herramienta sencilla para medir selección sobre rasgos fenotípicos en poblaciones naturales (Arnold 1983). Se distinguen dos líneas de trabajo, una dedicada a estudiar la relación entre capacidad de movimiento y eficacia biológica, y una segunda orientada a evaluar la relación entre morfología y capacidad de movimiento. Dentro del primer grupo, un gran número de trabajos han evaluado la selección natural sobre la capacidad de movimiento a través de la supervivencia y la

mayoría de ellos han encontrado evidencias de selección direccional positiva sobre este rasgo (revisado en Irschick et al. 2008). Sin embargo el estudio de la relación entre selección sexual y movimiento ha sido mucho más escaso, aunque una revisión reciente ha puesto de manifiesto que algunos rasgos relacionados con la capacidad de movimiento, tales como la resistencia, se verían favorecidos a través de la defensa del territorio, el cortejo o la competencia por orden de llegada (Husak & Fox 2008). Por su parte una estrecha relación ha sido puesta de manifiesto entre morfología y capacidad de movimiento en una amplia variedad de taxones tanto en vertebrados (Billerbeck et al. 2001; Iriarte-Diaz 2002; Garland & Freeman 2005; Calsbeek & Irschick 2007; Johansson et al. 2010), como en invertebrados (Fish & Nicastro 2003; Berwaerts et al. 2006).



**Fig. 1. Representación esquemática de las hipótesis alternativas que podrían explicar una relación positiva entre capacidad de movimiento y éxito reproductor.** El panel (A) representa la situación dónde el rasgo “capacidad de movimiento” influye directamente en el éxito de apareamiento vía competencia entre machos o elección de pareja llevada a cabo por las hembras. El panel (B) representa la situación donde los individuos con mejor capacidad de movimiento sobreviven más y, por tanto tienen un mayor éxito reproductor. Así, la capacidad de movimiento no implicaría competencia entre machos o elección de pareja y está por tanto bajo la influencia de la selección natural y no de la selección sexual. El panel (C) representa la situación donde la capacidad de movimiento contribuye directamente tanto a la supervivencia como al éxito reproductor. Por tanto, la capacidad de movimiento se ve favorecida por ambas fuerzas evolutivas. *Esquema tomado del trabajo de Husak & Fox (Husak & Fox 2008).*

No obstante, los fenotipos de las especies que vemos hoy en día son el resultado del balance de todos los agentes que han actuado como presiones de selección, y no de un único proceso (Blanckenhorn 2005). Así, en taxones donde ambos sexos adoptan distinto modo de vida una vez alcanzado el estado adulto, como es el caso de muchas especies de arañas, la importancia de desarrollar morfologías adaptadas al movimiento va a depender del rol sexual y va a variar entre machos y hembras (Fairbairn *et al.* 2007). De hecho, la evolución del dimorfismo sexual en el tamaño (a partir de ahora, SSD, del inglés *Sexual Size Dimorphism*), se ha explicado como el balance neto de distintas presiones de selección actuando sobre cada sexo (Blanckenhorn 2000; Blanckenhorn 2005). En particular, una buena parte de las hipótesis propuestas para explicar patrones de SSD con hembras de mayor tamaño que los machos se refieren a una selección que favorece un tamaño pequeño en los machos y que en muchos casos implica procesos relacionados directa o indirectamente con la movilidad de estos machos (Blanckenhorn 2000; Blanckenhorn 2005; Fairbairn *et al.* 2007).

Al mismo tiempo, muchos organismos están expuestos a una alta tasa de depredación mientras se desplazan (Vollrath & Parker 1992; Roff 2002; De Mas *et al.* 2009; Smith 2009). Así, por ejemplo, si nos referimos en concreto a la dispersión – bien sea para buscar nuevos territorios o para buscar pareja– un rasgo de la historia de vida asociado directamente a la capacidad de movimiento, los organismos deberían decidir entre dispersarse o no en función de un balance entre los potenciales beneficios y el riesgo de depredación existente, que dependerá de las condiciones ambientales en cada caso (Johnson & Gaines 1990). Así, podría darse una situación límite en el que unas determinadas condiciones ambientales podrían dar como resultado que para una población determinada el balance entre costos y beneficios asociados a la dispersión estuviera extremadamente sesgado, de forma que la estrategia óptima fuera la no dispersión, y, por tanto, tener una morfología adecuada para moverse distancias relativamente largas de forma eficiente no fuera importante. Un caso extremo de esta situación lo constituyen las arañas sociales, donde los individuos conviven dentro de un nido común y no existe una fase de dispersión previa a la época reproductora, sino que los hermanos se aparean entre sí dentro de la propia colonia patrón que se repite a lo largo de varias generaciones,

dando lugar a un crecimiento exponencial del grupo (Aviles 1997; Lubin & Bilde 2007).

A la vista de los antecedentes expuestos anteriormente, a lo largo de esta tesis se pretende estudiar algunas de las implicaciones ecológicas y/o evolutivas de la capacidad de movimiento relacionadas tanto con la selección natural como con la selección sexual. En particular en este trabajo se evalúan las implicaciones de la capacidad de movimiento en la selección de morfologías óptimas dependientes del tipo de hábitat o modo de vida, la evolución del SSD, la selección sexual por orden de llegada y la evolución de la sociabilidad en arañas.

### **MORFOLOGÍA Y CAPACIDAD DE MOVIMIENTO**

La capacidad de movimiento engloba a un conjunto de variables como son la velocidad de escape, la velocidad de crucero y la resistencia (en inglés “*endurance*”), cada una de las cuales puede tener una importancia relativa distinta en diferentes funciones vitales. Con el objetivo de encontrar una forma de evaluar globalmente la capacidad de movimiento, durante los últimos años muchos investigadores han medido lo que se ha denominado “máximo rendimiento de un organismo” (del inglés “*whole-organism performance*”), definida como la máxima habilidad de un organismo para realizar una tarea relevante ecológicamente, como puede ser la máxima velocidad que un organismo puede alcanzar (Irschick et al. 2008). Sin embargo, algunos autores han detectado que no siempre hay una correspondencia entre la máxima velocidad que un organismo puede alcanzar –normalmente evaluada en el laboratorio– y la velocidad que un individuo alcanza en el campo, puesto que los organismos rara vez se mueven al límite de sus posibilidades (Irschick 2003; Husak & Fox 2006). Como resultado, ha surgido un nuevo concepto “rendimiento ecológico” (del inglés “*ecological performance*”), que describe cómo los individuos hacen uso de su velocidad máxima potencial (Irschick 2003; Husak & Fox 2006). De hecho, se ha encontrado que incluso una variable de “rendimiento ecológico” como puede ser la velocidad en *sprint* puede variar dependiendo del contexto – ej. escapando de depredadores o capturando presas – dentro de una especie (Pruitt & Husak 2010).

Si bien la existencia de un fuerte nexo entre morfología y capacidad de movimiento es un patrón generalizado tanto en vertebrados como invertebrados (Billerbeck et al. 2001; Iriarte-Díaz 2002; Fish & Nicastro 2003; Garland & Freeman 2005; Berwaerts et al. 2006; Calsbeek & Irschick 2007; Johansson et al. 2010), la dirección y la fuerza de esta relación entre tamaño y/o forma corporal y habilidad para moverse varía a lo largo de los distintos taxones y depende del tipo de hábitat (Calsbeek 2008). Centrándonos en locomoción sobre la superficie terrestre, los lagartos se han convertido en un modelo de estudio. En principio se espera que los animales más grandes se muevan más rápido, debido a que sus patas más largas les permitirían tener una mayor longitud del paso (Bauwens et al. 1995). La mayoría de los resultados de los trabajos realizados en lagartos son consistentes con esta predicción, tanto en estudios llevados a cabo entre especies (Losos 1990), como dentro de una especie (Miles 2004; Husak & Fox 2006; Calsbeek & Irschick 2007). Aunque nuestro conocimiento sobre capacidad de movimiento en otros taxones es mucho más limitado, también se ha encontrado una relación positiva entre tamaño corporal y velocidad en trabajos intra-específicos en otros animales, como serpientes (Jayne & Bennett 1990), ranas (Johansson et al. 2010), ratas (Billerbeck et al. 2001) o una especie de araña que vive en la vegetación (familia Theridiidae) (Brandt & Andrade 2007a). Por el contrario, no se encontró ninguna relación entre estas dos variables en otras dos familias de arañas que viven sobre el suelo (familias Lycosidae y Agelenidae) (Pruitt 2010).

En relación a la escalada, un sencillo modelo biomecánico basado en la fuerza de la gravedad propuso una relación negativa entre tamaño y velocidad de escalada (Moya-Laraño et al. 2002a). Este patrón ha sido encontrado en algunos trabajos experimentales llevados a cabo con arañas (Moya-Laraño et al. 2007b), pero no en otros (Brandt & Andrade 2007a; Prenter et al. 2010). Recientemente, un estudio comparativo que incluía arañas de una amplia variedad de tamaños mostró que la relación entre velocidad de escalada y tamaño era curvilínea, presentando un máximo para tamaños de 4.7 mm (Moya-Laraño et al. 2009). Además es interesante resaltar el hecho de que la velocidad de escalada varía dependiendo del diámetro de la superficie por la que se escala (Prenter et al. 2010), lo cual podría explicar, al menos parcialmente, los distintos patrones encontrados.

Además, algunos organismos terrestres utilizan formas particulares de locomoción, como es el caso de las arañas que pueden realizar desplazamientos por el aire utilizando su seda. En concreto, las arañas realizan dos tipos de locomoción mediados por seda, denominados “*ballooning*” y puenteo o “*bridging*”, también conocido este último como “*rappelling*” (Bonte et al. 2009). Para hacer “*ballooning*” una araña produce una o varias hebras de seda y luego “despega” desde la superficie donde se encuentra para ser arrastrada por el viento como si de una cometa se tratase. El *ballooning* se utiliza para movimientos de dispersión de larga distancia (Bonte et al. 2009). Por su parte, para puentear una araña produce una hebra de seda que el viento dirige hasta que se engancha en otra rama cercana. La araña, tras tensar el hilo, cruza desplazándose por el hilo boca-arriba (Peters 1990; Linn 2001; Bonte et al. 2009). El puenteo se utiliza en desplazamientos a corta y media distancia, del orden de varios metros (Bonte et al. 2009). Poco se conoce acerca de cuáles son las morfologías óptimas para estos dos tipos de locomoción, aunque los pocos estudios existentes al respecto sugieren que existiría una limitación para las arañas muy grandes para moverse ya sea mediante *ballooning* (Roff 1991; Henschel et al. 1995; Schneider et al. 2001) o mediante puenteo (Morse & Fritz 1982).

Finalmente, es importante tener en cuenta que la mayoría de los trabajos realizados hasta la fecha han evaluado velocidad máxima en *sprint* o resistencia locomotora (Irschick et al. 2008 y referencias allí citadas), mientras la velocidad de crucero se ha medido sólo raramente. La velocidad de crucero podría tener especial importancia en tareas tales como la búsqueda de pareja, y por tanto influir en la selección sexual (Moya-Laraño et al. 2002a; Husak & Fox 2008).

## **EVOLUCIÓN DEL DIMORFISMO SEXUAL EN EL TAMAÑO**

La evolución del SSD, así como el análisis de las causas próximas y últimas que lo originan, es un tema que despierta gran interés en investigación de acuerdo con el gran número de trabajos que se están publicando en la actualidad (Abouheif & Fairbairn 1997; Fairbairn 1997; Blanckenhorn 2005; Fairbairn et al. 2007). El patrón mayoritario que encontramos en la naturaleza es un SSD moderado sesgado hacia las hembras, es decir, las hembras presentan un tamaño moderadamente superior a los machos (Fairbairn et al. 2007; Fairbairn 2007). Sin embargo, y aunque



con numerosas excepciones, el SSD sesgado hacia las hembras es el patrón más común en invertebrados y vertebrados ectotermos, mientras que un SSD sesgado hacia los machos es el patrón más general en aves y mamíferos (Székely 2007).

A lo largo del tiempo, los investigadores han intentado buscar un significado adaptativo a la evolución del SSD. Existen muchas hipótesis, muchas de ellas específicas de determinados grupos taxonómicos, pero, en general, el SSD sesgado hacia los machos se ha explicado mediante selección sexual por competencia intra-sexual (macho-macho). Los machos más grandes tendrían ventaja en los enfrentamientos directos macho-macho y serían, por tanto, los que accederían a las hembras en una mayor proporción, consiguiendo mayor éxito reproductor (Darwin 1871; Andersson 1994). Por su parte, la hipótesis más aceptada para explicar el SSD sesgado hacia las hembras es la conocida como hipótesis de la fecundidad (Head 1995). Según esta hipótesis existe una relación positiva entre el tamaño de la hembra y el éxito reproductor (mediado por el número de huevos) que favorece un incremento en el tamaño promedio de dichas hembras. Adicionalmente, se han propuesto un gran número de hipótesis que intentan explicar tanto la evolución como el mantenimiento del SSD, así como la gran variación en el grado de SSD existente en el reino animal. Para los distintos grupos taxonómicos, actualmente se están poniendo a prueba las distintas hipótesis a la vez que se siguen proponiendo nuevas ideas (revisado en Blanckenhorn 2005 & Fairbairn *et al.* 2007).

En concreto en arañas, se han propuesto un considerable número de hipótesis adaptativas de la evolución del SSD que intentan explicar la selección para disminuir el tamaño de los machos (revisado en Foellmer & Moya-Laraño 2007): Hipótesis del Canibalismo Sexual (Elgar 1992); Hipótesis de Ghiselin-Reiss o de la maduración temprana (Ghiselin 1974; Reiss 1989); Modelo de Mortalidad Diferencial (Vollrath & Parker 1992; De Mas *et al.* 2009) e Hipótesis de la Gravedad (Moya-Laraño *et al.* 2002a). Estas hipótesis no son necesariamente excluyentes.

La hipótesis de la gravedad (Moya-Laraño *et al.* 2002a) propone una explicación para la evolución del SSD relacionada con favorecer una alta movilidad en los machos. La hipótesis de la gravedad ofrece una explicación sólida a la selección para mantener los machos de pequeño tamaño y la evolución del SSD extremo basándose en la restricción física del peso sobre la velocidad de escalada, y

predice una relación inversamente proporcional entre el tamaño y la velocidad de escalada. No obstante, la base biomecánica de esta hipótesis ha sido recientemente debatida (Brandt & Andrade 2007a; Brandt & Andrade 2007b; Moya-Laraño et al. 2007c). Paralelamente a la discusión sobre su base teórica, la hipótesis de la gravedad se ha puesto a prueba experimentalmente con resultados que en algunos casos han apoyado la hipótesis (Moya-Laraño et al. 2007b), pero no en otros (Foellmer & Fairbairn 2005a; Brandt & Andrade 2007a; Prenter et al. 2010). No obstante, un estudio comparativo, basado en una muestra con un amplio rango de tamaños, ha aportado luz a la discusión sobre la Hipótesis de la Gravedad, encontrando que la relación entre velocidad de escalada y tamaño es curvilínea y, por tanto existe un tamaño óptimo para escalar que corresponde a 7.4 mm (Moya-Laraño et al. 2009). Según este mismo trabajo, el SSD extremo evolucionaría sólo en arañas que vivan en hábitats elevados y en aquellas especies donde el tamaño promedio de las hembras fuera mayor que el tamaño óptimo de escalada.

#### **SOCIABILIDAD Y DISPERSIÓN EN ARAÑAS**

De las más de 40000 especies conocidas de arañas (Platnick 2011), la amplia mayoría se caracterizan por una vida solitaria, y sólo unas pocas especies se comportan como especies sociales. Sin embargo, a pesar de ser poco frecuente, el fenómeno de la sociabilidad ha evolucionado repetidamente en arañas (Aviles 1997; Agnarsson 2006; Johannesen et al. 2007).

Encontramos distintos grados de sociabilidad en arañas, dependiendo, en primer lugar de si cada uno de los individuos construye una tela individual, “territorio” y entonces a este tipo de arañas se les conoce como *arañas territoriales* o *coloniales*, o por el contrario, comparten un nido común, y entonces se denominan *arañas no territoriales*. Y en segundo lugar, según los individuos de la colonia se mantengan juntos durante todo o parte de su ciclo de vida, distinguiéndose así entre *sociabilidad permanente* o *periódica*, respectivamente (Aviles 1997). La colonialidad es el tipo de sociabilidad más común en arañas, de la que se conocen 53 especies que incluyen tanto especies de colonialidad periódica como permanente (Whitehouse & Lubin 2005). Sin embargo las arañas no territoriales han sido más estudiadas, dado

que presentan un grado de sociabilidad más complejo y, por tanto, resultan más interesantes desde un punto de vista evolutivo (revisado en Lubin & Bilde 2007).

A aquellas especies que presentan el grado de sociabilidad más complejo se las denomina arañas permanentemente sociales no territoriales, o simplemente *arañas sociales* (Aviles 1997; Lubin & Bilde 2007; Purcell & Aviles 2007). Estas arañas forman grupos familiares que consisten en un nido común rodeado por telas de captura, donde los individuos habitan durante toda su vida, y los miembros de la colonia cooperan en el forrajeo y el cuidado de las crías (Aviles 1997; Lubin & Bilde 2007). Este grupo es el menos común, existiendo menos de 25 especies conocidas (Aviles 1997; Agnarsson 2006). También encontramos arañas no territoriales de sociabilidad periódica, conocidas como *arañas subsociales*, en que los individuos conviven dentro del mismo nido y cooperan en tareas de forrajeo sólo durante parte de su vida (Aviles 1997; Lubin & Bilde 2007).

Es interesante destacar el hecho de que todas las especies sociales se concentran en regiones tropicales del mundo, mientras que especies subsociales filogenéticamente relacionadas extienden su distribución hacia las zonas templadas (Kraus & Kraus 1988; Aviles & Gelsey 1998; Agnarsson 2006; Viera et al. 2006; Jones et al. 2007). Así mismo, también se ha encontrado un gradiente altitudinal en el grado de sociabilidad, con las especies más sociales localizadas en las zonas más bajas (Aviles et al. 2007). De hecho, una de las hipótesis más aceptadas para explicar la ventajas de la sociabilidad en arañas propone que la cooperación en tareas de forrajeo permite a estas especies acceder a presas de mayor tamaño, las cuales son abundantes en zonas tropicales, y que no serían un recurso disponible si estos individuos cazaran de forma individual (Aviles 1997; Guevara & Aviles 2007). Otra de las potenciales ventajas de la vida en grupo hace referencia a un menor coste energético por individuo en tareas de reparación de tela debido a las lluvias torrenciales, muy abundantes en zonas tropicales (Purcell & Aviles 2008).

En relación a la evolución de la sociabilidad, se ha propuesto que las especies sociales habrían evolucionado de antecesores subsociales, y éstos a su vez de especies con una extensión del periodo de cuidado parental (Aviles 1997; Johannesen et al. 1998; Agnarsson 2006; Lubin & Bilde 2007).

Las arañas sociales constituyen un sistema muy interesante para estudiar la dispersión, puesto que la evolución de la sociabilidad ha sido acompañada de la pérdida de una fase dispersiva previa al apareamiento en las arañas sociales, con los hermanos apareándose entre sí durante sucesivas generaciones, alcanzando por tanto altos niveles de endogamia. En las arañas subsociales, sin embargo, los hermanos conviven durante la fase de crecimiento pero se dispersan antes de la estación reproductora para aparearse con individuos de otras colonias (revisado en Aviles 1997; Lubin & Bilde 2007). Probablemente las distintas características ecológicas de ambos grupos de arañas provocan que el balance entre costes y beneficios asociados a la dispersión sea distinto para arañas sociales y subsociales. Así, en el caso de las arañas sociales, existe una larga historia de endogamia que podría haber purgado la mayoría de los alelos deletéreos recesivos (Bilde et al. 2005; Bilde et al. 2007). Además, la estructura poblacional se caracteriza por una proporción de sexos muy sesgada hacia las hembras y una alta similitud genética entre colonias vecinas (Johannesen et al. 2002; Johannesen et al. 2009; Agnarsson et al. 2010), mientras que la probabilidad de supervivencia de nuevas colonias fundadas por hembras solitarias es muy baja (Vollrath 1982; Bilde et al. 2007). Por el contrario, en las arañas subsociales la proporción de sexos es aproximadamente 1:1, con lo cual los machos se enfrentan a una mayor competencia entre sí, y también existe una mayor variabilidad genética entre colonias vecinas (Johannesen et al. 1998; Johannesen & Lubin 1999; Johannesen & Lubin 2001; Johannesen et al. 2002; Johannesen et al. 2009; Agnarsson et al. 2010).

#### **SELECCIÓN SEXUAL POR COMPETENCIA CAÓTICA O COMPETENCIA POR ORDEN DE LLEGADA**

En su intento por explicar las enormes diferencias existentes en algunas especies entre machos y hembras, Darwin (Darwin 1859; Darwin 1871) desarrolló su teoría de la Selección Sexual. Según ésta, la selección sexual surge de las diferencias en éxito reproductor causadas por la competencia por aparearse, en contraste a la selección natural, causada por la lucha por la supervivencia (Darwin 1871). De acuerdo con una terminología más moderna, la selección sexual puede ser definida como un caso particular de la selección natural en que la selección actúa sobre la variación entre miembros de un mismo sexo en la habilidad para conseguir

parejas, apareamientos, o fertilizaciones (Savalli 2001). Además, las fuerzas selectivas pueden actuar directa o indirectamente, implicando a individuos adultos de la misma especie, ya sean del mismo sexo (selección intra-sexual), o del sexo opuesto (selección inter-sexual).

Probablemente debido a que implica la evolución de caracteres sexuales secundarios que resultan especialmente llamativos, los mecanismos más estudiados de la selección sexual han sido con diferencia la competencia por enfrentamiento, es decir, enfrentamientos macho-macho, y la elección de pareja (revisado en Andersson 1994; Savalli 2001; Huber 2005). Otros mecanismos cada vez más estudiados son la competencia espermática, estudiada tanto en insectos y arácnidos (Choe & Crespi 1997), como en aves y mamíferos (Birkhead & Moller 1992; Birkhead & Moller 1998; Gomendio et al. 2006) y la selección críptica de la pareja (Eberhard 1996). Además, el estudio del conflicto intersexual, poniendo de manifiesto los diferentes intereses y óptimos de eficacia biológica de cada sexo, ha experimentado un auge importantísimo en la primera década del siglo XXI (Arnqvist & Rowe 2005). Sin embargo, el papel de la competencia por orden de llegada se ha infravalorado, y aún hoy en día se conoce muy poco sobre los mecanismos implicados (Andersson 1994; Moya-Laraño et al. 2002a).

La selección por orden de llegada es un tipo de competencia indirecta entre los individuos de un mismo sexo, en una “carrera” por alcanzar al sexo opuesto. Generalmente son los machos los que compiten por las hembras. Este tipo de competencia no supone un enfrentamiento directo, sino que unos individuos poseen una ventaja frente al resto, lo que les permite acceder a las hembras en primer lugar (Ghiselin 1974; Andersson 1994). En general, la competencia por orden de llegada va a ser más importante cuando se relaja la competencia por enfrentamiento y la competencia por enfrentamiento disminuye cuando la densidad es baja, o en general, cuando hay una baja probabilidad de encuentro con el sexo opuesto (Ghiselin 1974; Moya-Laraño et al. 2002a). Algunas condiciones ecológicas que propician estas circunstancias son una distribución esparcida de hembras, o lo que es lo mismo, una densidad baja de hembras (Trivers 1972; Alcock 1980; Thornhill & Alcock 1983) o cuando las hembras son receptivas por un período muy corto de tiempo (Thornhill & Alcock 1983).

Uno de los mecanismos por los que la competencia por orden de llegada puede actuar, es favoreciendo a los individuos que maduren antes (Ghiselin 1974; Reiss 1989). Debido a la existencia de una relación genética positiva entre tamaño y tiempo de maduración (Roff 2000), esto supondrá una ventaja de los individuos más pequeños. Otro de los mecanismos por los que puede actuar la selección sexual por competencia por orden de llegada es favoreciendo a los individuos con mayor movilidad (Andersson 1994; Moya-Laraño et al. 2002a). La mayoría de los trabajos centrados en la selección por orden de llegada han sido dirigidos a esta segunda faceta, siendo generalmente aceptada la idea de que este tipo de competencia debe favorecer a los machos más móviles y/o más ágiles (Schwagmeyer 1988; Able 1999; Legrand & Morse 2000; Moya-Laraño et al. 2002a; Kelly et al. 2008).

La competencia por orden de llegada, asociada a poliginia, se ha reconocido como un mecanismo común entre anfibios (Wells 1977; Able 1999) e insectos (Thornhill & Alcock 1983; Partridge et al. 1987; Hanks et al. 1996; Moya-Laraño et al. 2007a; Kelly et al. 2008), pero ha sido sólo puesta de manifiesto ocasionalmente en otros taxones como arañas (Moya-Laraño et al. 2002a; Foellmer & Fairbairn 2005b), aves (Post & Greenlaw 1982; Raihani et al. 2006) y mamíferos (Schwagmeyer 1988).

## Las arañas como sistema de estudio

Las arañas constituyen el Orden Araneae dentro de la Clase Arachnida. Existen más de 40000 especies conocidas (Platnick 2011), agrupadas en cerca de 150 familias. Típicamente son terrestres, aunque una especie *Argyroneta aquatica*, se ha adaptado a vivir en el agua dentro de una burbuja de aire que ella misma construye (Schutz & Taborsky 2005). Son depredadores generalistas que se alimentan principalmente de artrópodos, aunque también pueden cazar otros invertebrados e incluso vertebrados de pequeño tamaño. Han colonizado una gran diversidad de hábitats adaptándose a condiciones ecológicas muy variables (Wise 1993).

Las arañas poseen una serie de características que las convierten en un sistema ideal para el objeto de esta tesis:

1. A lo largo de toda su filogenia, existen especies con características ecológicas muy diferentes y, en consecuencia, con morfologías muy diversas adaptadas al movimiento en cada tipo de hábitat. Encontramos así especies que viven a ras de suelo en madrigueras que construyen, como por ejemplo, algunas especies de la familia Lycosidae, pero también encontramos arañas que viven en la vegetación, cerca del suelo, como el género *Latrodectus* (Theridiidae), o a una altura considerable, viviendo sobre las flores, como algunas arañas cangrejo (Thomisidae). Encontramos especies que construyen telas orbiculares, más o menos verticales, como por ejemplo el género *Argiope* (Araneidae), y existen otras que construyen telas horizontales muy densas a modo de sábanas y viven colgando cabeza abajo de sus telas, como la familia Linyphiidae. Existen especies que viven en el interior de cuevas, como es el caso de algunas especies de la familia Oecobiidae, incluso dentro de este grupo algunas especies hoy en día pueden encontrarse en el interior de construcciones humanas como es el caso del género *Pholcus* (familia Pholciidae) (Foelix 1996). En muchos grupos el estilo de vida de machos y hembras es muy distinto una vez alcanzado el estado adulto, permaneciendo

las hembras como sedentarias en sus telas o refugios, siendo los machos el sexo encargado de buscar pareja, por lo que sus hábitos pasan a ser mucho más errantes. Es el caso, por ejemplo, de *Lycosa tarantula* (Moya-Laraño et al. 2002a; Moya-Laraño et al. 2003; Moya-Laraño et al. 2004) o *Argiope aurantia* (Foellmer & Fairbairn 2005a; Foellmer & Fairbairn 2005b). Sin embargo, en otras especies, como por ejemplo *Pardosa milvina*, machos y hembras presentan un grado de actividad similar (Walker & Rypstra 2003). De hecho, un estudio comparativo reciente que evalúa tasas de actividad en machos y hembras a lo largo de una amplia variedad de taxones en arañas, muestra que incluso existen especies donde la tasa de movimiento de las hembras sería mayor a la de los machos, puesto que caen con mayor frecuencia en las trampas de caída (De Mas et al. 2009).

2. Las arañas pueden realizar distintos tipos de desplazamiento dependiendo del hábitat donde vivan. Así, además de andar y correr sobre superficies horizontales, y escalar superficies verticales, muchas especies de arañas pueden desplazarse utilizando seda mediante “ballooning” o puenteo (Peters 1990; Linn 2001; Bonte et al. 2009). Estos tipos de locomoción mediados por seda son exclusivos de las arañas.
3. En las arañas, el SSD es común, siendo en la mayoría de los casos las hembras de mayor tamaño que los machos (Hormiga et al. 2000). No obstante existe una gran variación entre las especies (Head 1995; Vollrath 1998; Hormiga et al. 2000), desde SSD extremo con hembras gigantes y machos enanos, principalmente en el clado Orbiculariae y la familia Thomisidae, hasta SSD sesgado hacia los machos como en *Argyroneta aquatica*. Las arañas son los únicos animales terrestres que exhiben tal rango de SSD y donde además el SSD extremo es relativamente frecuente (Ghiselin 1974; Foellmer & Moya-Laraño 2007). Es también interesante el hecho de que tanto SSD sesgado hacia los machos, como SSD extremo sesgado hacia las hembras ocurra varias veces en taxones distintos y el SSD extremo haya evolucionado varias veces de forma independiente, incluso dentro de las arañas orbiculares (Hormiga et al. 2000).



4. En algunas especies de arañas ha evolucionado una forma de sociabilidad en la que el balance entre costes y beneficios asociados a la dispersión parece estar sesgado de tal modo que los individuos no se dispersan, sino que viven juntos dentro del nido cooperando en tareas como la captura de presas o la reparación de la tela, y los propios hermanos se aparean entre sí durante sucesivas generaciones (revisado en Aviles 1997; Lubin & Bilde 2007). Las arañas sociales, por tanto, constituyen un sistema ideal para estudiar la capacidad de movimiento en relación al grado de sociabilidad.
5. En aquellas especies donde las hembras son sedentarias, y los machos son el sexo encargado de buscar pareja, una vez ambos alcanzan el estado adulto, se cumple el escenario ecológico donde se relaja la competencia por concurso y se favorece la competencia por orden de llegada. En primer lugar, la distribución de las hembras es agregada a escalas relevantes para la búsqueda de pareja (Riechert 1974) en muchas especies (ej. Fernandez-Montraveta et al. 1991; Marshall 1995; Lloyd & Elgar 1997), existiendo una baja probabilidad de encuentros con el otro sexo (Ghiselin 1974). Adicionalmente la densidad de machos es baja, especialmente al final de la época reproductora, debido a la elevada mortalidad que sufren (Vollrath & Parker 1992; Walker & Rypstra 2003).

## **Justificación y Objetivos**

El objetivo principal de esta tesis es estudiar algunas implicaciones ecológicas y evolutivas de la capacidad de movimiento de los organismos utilizando las arañas como sistema de estudio. En concreto, estudiamos la evolución del tamaño y morfologías seleccionados en función del tipo de hábitat. Así mismo investigamos si la selección, al favorecer un incremento de la movilidad en los machos, podría explicar la evolución del SSD en arañas. Adicionalmente, profundizamos en el estudio de los mecanismos relacionados con la capacidad de movimiento que están implicados en la pérdida de una fase dispersiva previa al apareamiento en las arañas sociales. Por último, evaluamos el papel de la selección sexual por orden de llegada en una especie de araña de suelo con escaso SSD.

### **I. EVOLUCIÓN DEL TAMAÑO Y FORMA ÓPTIMOS ADAPTADOS A MAXIMIZAR LA CAPACIDAD DE MOVIMIENTO EN FUNCIÓN DEL MODO DE VIDA**

Como se ha explicado en la introducción de esta tesis, en arañas que viven en la vegetación, a cierta altura sobre el suelo además de correr y andar por superficies horizontales, así como escalar, los individuos pueden desplazarse mediante puenteo utilizando seda (Peters 1990; Linn 2001; Bonte et al. 2009). Durante años el puenteo ha sido un tipo de desplazamiento apenas considerado en la bibliografía (Peters 1990; Linn 2001; Ramos et al. 2005; Bonte et al. 2009). Sin embargo, los escasos datos disponibles sugieren que el puenteo podría ser el tipo de locomoción más frecuente al menos en machos de muchas de las arañas que viven en la vegetación (Linn 2001). De hecho, las hebras de seda resultantes de los desplazamientos por puenteo entre varias plantas son fácilmente visibles y muy abundantes en una gran variedad de ecosistemas terrestres (Corcobado y Moya-Laraño, observaciones personales).

La locomoción es una actividad biológica que supone un alto coste energético para los animales (Peters 1983; Kotiaho et al. 1998; Alexander 2003; Kabat et al.

2007). Es de esperar, por tanto, que en cada situación los individuos se muevan de forma eficiente, minimizando el gasto de energía. Como consecuencia, restricciones a parte, a lo largo de la evolución se podrían haber seleccionado morfologías adecuadas para moverse en cada tipo de hábitat.

La mayoría de los estudios sobre locomoción en invertebrados se han centrado en insectos y han evaluado el movimiento desde el punto de vista mecánico, analizando cómo el animal ejecuta la fuerza necesaria para mover su cuerpo en cada caso (Full & Tu 1990; Full & Tullis 1990; Schmitt & Holmes 2001; Schmitt et al. 2002; Lipp et al. 2005). Además, la mayoría de estos trabajos utilizan un enfoque teórico o bien eligen una o pocas especies como modelo de estudio (Brandt & Andrade 2007a; Prenter et al. 2010). Son muy pocos los trabajos que estudian el movimiento, directa o indirectamente, a lo largo de las especies mediante un enfoque comparativo (Moya-Laraño et al. 2002; Moya-Laraño et al. 2009). Asumiendo que el puenteo es uno de los tipos de locomoción más frecuentes en arañas que viven en la vegetación, el primer objetivo que nos planteamos en esta tesis es contrastar la hipótesis de si la evolución de la forma de las arañas que viven en la vegetación se correspondería con la morfología óptima esperada si la evolución hubiera maximizado la capacidad para puentear (**capítulo I**). Puesto que se ha sugerido que los animales que se desplazan colgados por sus patas, como ocurre habitualmente en muchos primates, podrían beneficiarse de la mecánica pendular durante la locomoción (Swartz 1989), en este capítulo nosotros emitimos la hipótesis de que la morfología de las arañas podría haber evolucionado de acuerdo a las predicciones de la mecánica pendular. De acuerdo con esta hipótesis, las arañas que viven en la vegetación, y que habitualmente se desplazan mediante puenteo, tendrían patas relativamente más largas que las arañas de suelo y que habitualmente caminan sobre sus patas, las cuales tiene que soportar el peso de su propio cuerpo en cada paso. Para ello indujimos experimentalmente a puentear a arañas que viven en la vegetación, e inducimos a correr sobre una superficie horizontal a estas mismas arañas; además de a otras especies de arañas típicamente de suelo. Medimos tanto la velocidad alcanzada en cada tipo de desplazamiento como el tamaño y la forma de los individuos. Nuestra muestra incluyó especies de arañas de una amplia variedad taxonómica y un extenso rango de tamaños. Se utilizó

el método comparativo en biología evolutiva (Felsenstein 1985; Garland et al. 2005) para el análisis de los datos.

## **II. EVOLUCIÓN DEL DIMORFISMO SEXUAL EN EL TAMAÑO (SSD) EN RELACIÓN A LA CAPACIDAD DE MOVIMIENTO.**

Los últimos trabajos de revisión sobre el estudio del SSD en arañas coinciden en que la selección por la fecundidad (Head 1995), actuando sobre la cantidad de descendencia y aumentando como consecuencia el tamaño de las hembras, es el factor más importante que ha contribuido a la evolución del SSD (Blanckenhorn 2000; Huber 2005; Blanckenhorn 2005; Foellmer & Moya-Laraño 2007). Esta afirmación viene apoyada además tanto por análisis cladísticos de reconstrucción de los tamaños ancestrales (Coddington et al. 1997; Hormiga et al. 2000) como por análisis comparativos (Head 1995; Prenter et al. 1999). Sin embargo, el problema no está totalmente resuelto, dado que falta resolver una segunda pregunta, ¿qué fuerza de selección mantiene los machos pequeños? (Blanckenhorn 2000) o la pregunta similar, ¿por qué algunas especies tienen hembras gigantes con machos enanos mientras otras tienen hembras grandes con machos tan solo un poco más pequeños?

La hipótesis de la gravedad (Moya-Laraño et al. 2002) relaciona la evolución del SSD con la capacidad de movimiento, proponiendo que los machos más pequeños serían favorecidos puesto que escalarían de forma más eficiente, aunque existe una amplia controversia en relación a esta hipótesis (Brandt & Andrade 2007a; Moya-Laraño et al. 2007b; Moya-Laraño et al. 2007c; Moya-Laraño et al. 2009; Prenter et al. 2010). No obstante, probablemente los machos que viven a cierta altura sobre la vegetación, además de escalar, utilizan el puenteo para buscar pareja (Peters 1990; Linn 2001), con lo cual sería esperable una selección por favorecer machos que puenteen eficientemente.

Se ha puesto de manifiesto que la producción de seda para la construcción de telas requiere tanto un alto coste energético (Opell 1998; Blackledge et al. 2006; Swanson et al. 2006; Blackledge & Zevenbergen 2007; Coslovsky & Zschokke 2009), como de nutrientes (Craig et al. 2000) por parte de la araña y, por tanto, es de esperar que la producción de seda para puentear también suponga un alto coste,

especialmente para arañas muy grandes. De hecho, Morse & Fritz (Morse & Fritz 1982) detectaron que las hembras más grandes de *Mysumena vatia* (Thomisidae) no podían puentear. Una posible explicación para este fenómeno es que cuando el tamaño de la hembra es muy grande, esta no puede utilizar el puenteo como medio de locomoción para desplazarse entre dos puntos elevados puesto que debido a que la seda es un material muy elástico, el peso elevado de la araña curvaría tanto el hilo, con lo que la hebra podría llegar al suelo, impidiendo por tanto a la araña llegar a su destino inicial (Morse & Fritz 1982). Así, el siguiente objetivo de esta tesis fue desarrollar un modelo biomecánico para comprobar si las propiedades mecánicas de la seda de las arañas podían explicar la limitación de las arañas más pesadas para puentear (**capítulo II**). Basándose en los datos existentes sobre las propiedades mecánicas de la seda procedente de las glándulas “*minor ampullate*”, que es el tipo de seda utilizado para puentear (Peters 1990), el modelo compara el mínimo diámetro de seda que sería necesario para puentear sin que el hilo se curve tanto que alcance el suelo, con el diámetro de seda realmente producido por arañas en función de su masa.

Teniendo en cuenta que existe una diferencia muy clara entre la tendencia a puentear de machos y hembras, especialmente en aquellas especies con hembras gigantes y, por tanto, SSD extremo (Corcobado & Moya-Laraño observación personal), junto con los resultados del capítulo II de esta tesis donde se pone de manifiesto que existe una restricción física impuesta por las propiedades biomecánicas de la seda para que las arañas más grandes puenteen de forma eficiente, el siguiente objetivo de esta tesis es contrastar la hipótesis de que el puenteo puede ser responsable de la evolución del SSD extremo en arañas (**capítulo III**). Para desarrollar este objetivo contrastamos experimentalmente la propensión a puentear en 13 especies de arañas pertenecientes a dos clados independientes, Orbicularios y Tomísidos, donde se encuentran la mayoría de los casos de SSD extremo en arañas. Utilizamos el método comparativo para analizar los datos. Puesto que existen restricciones físicas para que las arañas muy pesadas puedan puentear de forma óptima (Morse & Fritz 1982; capítulo II), proponemos que la diferencia en la proporción de puentes entre machos y hembras puede explicar el patrón de SSD. O lo que es lo mismo, en aquellas especies con escaso SSD y por tanto hembras y machos pequeños, ambos sexos tendrían una alta tendencia a puentear,

mientras que en especies con un SSD extremo y hembras gigantes, los machos mostrarían una tendencia a puentear mucho mayor que la de las hembras. Así mismo, predecimos que la masa corporal explicaría la propensión a puentear tanto en machos como en hembras.

### **III. CAPACIDAD DE DISPERSIÓN EN FUNCIÓN DEL GRADO DE SOCIABILIDAD EN ESPECIES DEL GÉNERO *ANELOSIMUS* (THERIDIIDAE).**

Como se ha adelantado en la introducción de esta tesis, las arañas sociales constituyen un excelente modelo de estudio para estudiar la dispersión puesto que existen indicios que sugieren que el balance entre costes y beneficios asociados a la dispersión varía con el grado de sociabilidad (revisado en Aviles 1997; Lubin & Bilde 2007), de tal manera que sería esperable una pérdida en la capacidad de dispersión en las arañas sociales en comparación con las arañas subsociales. Sin embargo, hasta la fecha todos los trabajos que han estudiado la capacidad de dispersión en relación a la sociabilidad en arañas lo han hecho de forma indirecta a través del estudio de la estructura genética poblacional (Johannesen et al. 1998; Johannesen & Lubin 1999; Johannesen & Lubin 2001; Johannesen et al. 2002; Johannesen et al. 2009; Smith et al. 2009; Agnarsson et al. 2010), la evaluación de clases de edad y/o relación de sexos (Aviles 1986; Aviles & Maddison 1991) o a través de algunos datos de recapturas de individuos en los alrededores de la colonia (Li & Kuan 2006; Lubin et al. 2009). Por el contrario, no existe ningún estudio hasta la fecha que haya medido directamente la habilidad de los individuos para dispersarse desde un punto de vista mecanístico y funcional, a lo largo de un gradiente de sociabilidad en arañas.

En el estudio de la evolución de la sociabilidad en arañas, el género *Anelosimus* (Familia Theridiidae), se ha convertido en un sistema modelo dado que incluye múltiples orígenes independientes de la sociabilidad (Aviles 1997; Agnarsson 2006; Agnarsson et al. 2006; Lubin & Bilde 2007; Agnarsson et al. 2007). Así mismo, se ha mostrado que al menos en una especie europea del género *Anelosimus*, morfológicamente muy similar a las especies subsociales y sociales del mismo género (Corcobado, observación personal), el puenteo es un mecanismo habitualmente utilizado para desplazarse (capítulo I de esta tesis). El tercer objetivo general de esta tesis consiste en evaluar desde un punto de vista mecanístico y

funcional la habilidad para dispersarse mediante puenteo en arañas con distinto grado de sociabilidad (**capítulo IV**). Para ello medimos experimentalmente la tendencia y la habilidad para puenteo en 7 especies de *Anelosimus* que exhiben distinto grado de sociabilidad. Predecimos que a medida que aumenta el grado de sociabilidad, se producirá una pérdida progresiva y continua en la habilidad para dispersarse mediante puenteo. Además, puesto que unas patas desproporcionadamente largas son ventajosas para la locomoción mediante puenteo, pero a su vez tienen unos costes en términos de pérdida de eficiencia en la locomoción sobre superficies horizontales (capítulo I de esta tesis), los cuáles podrían ser importantes a veces en la vida colonial, proponemos que el mecanismo por el que se estaría produciendo esta pérdida de habilidad para puenteo en las arañas más sociales consistiría en un acortamiento de la longitud relativa de la pata, lo que conllevaría a una forma menos especializada para el puenteo.

#### **IV. LOCOMOCIÓN SOBRE SUPERFICIES HORIZONTALES . IMPLICACIONES EN LA SELECCIÓN NATURAL Y LA SELECCIÓN SEXUAL.**

En cuanto a locomoción sobre superficies horizontales (sobre el suelo desnudo o con poca vegetación), el patrón más generalizado entre lagartos, muestra que los individuos más grandes se mueven más rápido debido a que sus patas de mayor longitud les permiten avanzar mayores distancias en cada paso (Losos 1990; Bauwens et al. 1995; Miles 2004; Husak & Fox 2006; Calsbeek & Irschick 2007). Sin embargo, la mecánica pendular predice que tener unas patas muy largas resulta perjudicial a la hora de desplazarse sobre superficies horizontales (capítulo I de esta tesis). Framenau (Framenau 2005) propuso que los individuos con patas muy largas podrían disminuir su peso para compensar la pérdida de fuerza, lo que podría resultar en una selección hacia un menor tamaño. En los escasos trabajos que han medido velocidad de movimiento en arañas los resultados varían dependiendo de la especie estudiada (Brandt & Andrade 2007a; Prenter et al. 2010; Pruitt & Husak 2010). Además, es interesante resaltar que casi la totalidad de los trabajos realizados hasta la fecha han evaluado la capacidad de movimiento a través de medir la velocidad de escape, mientras que la velocidad de crucero, que podría tener especial relevancia para la selección sexual por competencia por orden de llegada ha

sido raramente considerada (Miles 2004). El siguiente objetivo de esta tesis ha sido analizar cuáles son las variables morfológicas (tamaño, longitud relativa de la pata, y condición) que mejor explican la velocidad de escape y la velocidad de crucero en una araña de suelo, y que por tanto son susceptibles de ser favorecidas por selección natural y/o selección sexual (**capítulo V**). En este caso se utilizó como modelo los machos de *Lycosa tarantula* y se midió la velocidad de escape y la velocidad de crucero en cercados ubicados en el campo bajo condiciones ambientales naturales. En concreto, analizamos si existía una relación entre tamaño y velocidad tal cómo predice la hipótesis de una mayor longitud del paso (Bauwens et al. 1995), o si por el contrario la relación entre estas dos variables era negativa, tal como predice la mecánica pendular (capítulo I de esta tesis). Así mismo, puesto que en esta especie las hembras prefieren aparearse con machos en mejor condición (Rabameda-Bueno R, Aguado-de-la-Paz S, Fernández-Montraveta C & Moya-Laraño, J datos no publicados), proponemos la hipótesis de que la condición podría actuar como un hándicap dependiente de la calidad genética y comprobamos si los resultados son consistentes con esta hipótesis. Por último, analizamos si existe una relación entre velocidad de escape y velocidad de crucero y por tanto si los resultados obtenidos a partir de la velocidad de escape podrían ser extrapolados a los contextos ecológicos donde los individuos se mueven mayoritariamente a velocidad de crucero, como por ejemplo durante la búsqueda de pareja.

#### **V. SELECCIÓN SEXUAL POR COMPETENCIA POR ORDEN DE LLEGADA, UTILIZANDO COMO MODELO *LYCOSA TARANTULA*.**

Como hemos mencionado en la introducción de esta tesis, la competencia por orden de llegada ha sido estudiada escasamente en comparación con otras formas de selección sexual.

En arañas, y especialmente en aquellas especies donde existe un SSD extremo, se ha sugerido que la selección por orden de llegada podría desempeñar un papel importante seleccionando los machos más móviles (Legrand & Morse 2000; Moya-Laraño et al. 2002), existiendo además algunas evidencias puntuales (Foellmer & Fairbairn 2005b). Sin embargo, hasta donde nosotros sabemos no hay estudios que hayan evaluado el papel de la selección por orden de llegada en



especies con un moderado SSD. Merece también la pena resaltar el hecho de que la mayoría de los trabajos que han evaluado selección natural y selección sexual han medido selección sobre rasgos morfológicos, mientras que la selección sobre rasgos que hacen referencia a una habilidad o una capacidad como puede ser la movilidad, se ha evaluado en raras ocasiones (Irschick et al. 2008).

El último objetivo de esta tesis fue evaluar el papel de la selección sexual por orden de llegada en la araña lobo mediterránea, *Lycosa tarantula* (**capítulo VI**). Para llevar a cabo este objetivo seguimos la estación reproductora de esta araña en una parcela experimental, midiendo el movimiento de los machos a través del método de captura-recaptura. Calculamos gradientes de selección (Lande & Arnold 1983) sobre un rasgo comportamental, la movilidad, y dos rasgos morfológicos, tamaño y condición. Teniendo en cuenta que los datos existentes sobre esta especie sugieren que se dan las condiciones para que actúe la selección por orden de llegada (Fernandez-Montraveta et al. 1991; Fernandez-Montraveta & Ortega 1993; Fernandez-Montraveta & Ruano-Bellido 2000; Moya-Laraño et al. 2003; Fernandez-Montraveta & Cuadrado 2003; Fernandez-Montraveta & Cuadrado 2009), predecimos una selección positiva sobre la movilidad. Así mismo, a la vista de nuestros resultados anteriores acerca de la relación entre morfología y velocidad de crucero (capítulo V de esta tesis), predecimos una selección negativa sobre el tamaño. Por último, teniendo en cuenta los resultados mencionados anteriormente (capítulo V de esta tesis), acerca de la relación entre condición y movilidad, y considerando que los datos existentes apoyan la hipótesis de la condición actuando como un hándicap dependiente de la condición genética (capítulo V de esta tesis), predecimos una selección positiva sobre la condición corporal en machos de *L. tarantula*.

## Bibliografía

- Able,D.J. 1999. Scramble competition selects for greater tailfin size in male red-spotted newts (Amphibia: Salamandridae). *Behavioral Ecology and Sociobiology* 46, 423-428.
- Abouheif,E. & Fairbairn,D.J. 1997. A comparative analysis of allometry for sexual size dimorphism: Assessing Rensch's rule. *American Naturalist* 149, 540-562.
- Agnarsson,I. 2006. A revision of the New World eximius lineage of Anelosimus (Araneae, Theridiidae) and a phylogenetic analysis using worldwide exemplars. *Zoological Journal of the Linnean Society* 146, 453-593.
- Agnarsson,I., Aviles,L., Coddington,J.A. & Maddison,W.P. 2006. Sociality in Theridiid spiders: Repeated origins of an evolutionary dead end. *Evolution* 60, 2342-2351.
- Agnarsson,I., Maddison,W.P. & Aviles,L. 2007. The phylogeny of the social Anelosimus spiders (Araneae : Theridiidae) inferred from six molecular loci and morphology. *Molecular Phylogenetics and Evolution* 43, 833-851.
- Agnarsson,I., Maddison,W.P. & Aviles,L. 2010. Complete separation along matriline in a social spider metapopulation inferred from hypervariable mitochondrial DNA region. *Molecular Ecology* 19, 3052-3063.
- Alcock,J. 1980. Natural-Selection and the Mating Systems of Solitary Bees. *American Scientist* 68, 146-153.
- Alexander,R.M. 2003. *Principles of Animal Locomotion*. Princeton: Princeton University Press.
- Andersson,M. 1994. *Sexual Selection*. Princeton, NJ.: Princeton University Press.
- Arnold,S.J. 1983. Morphology, Performance and Fitness. *American Zoologist* 23, 347-361.
- Arnqvist,G. & Rowe,L. 2005. *Sexual Conflict*. Princeton: Princeton University Press.

- Aviles,L. 1986. Sex-Ratio Bias and Possible Group Selection in the Social Spider *Anelosimus-Eximius*. *American Naturalist* 128, 1-12.
- Aviles,L. & Maddison,W. 1991. When Is the Sex-Ratio Biased in Social Spiders - Chromosome-Studies of Embryos and Male Meiosis in *Anelosimus* Species (Araneae, Theridiidae). *Journal of Arachnology* 19, 126-135.
- Aviles,L. 1997. Causes and consequences of cooperation and premanent-sociality in spiders. In: The evolution of social behaviour in insects and arachnids. J.C. Choe & In: *The Evolution of Social Behaviour in Insects and Arachnids* (Ed. by J.Choe & B.Crespi), pp. 476-498. Cambridge, Cambridge Unviersity Press.
- Aviles,L. & Gelsey,G. 1998. Natal dispersal and demography of a subsocial *Anelosimus* species and its implications for the evolution of sociality in spiders. *Canadian Journal of Zoology-Revue Canadienne de Zoologie* 76, 2137-2147.
- Aviles,L., Agnarsson,I., Salazar,P.A., Purcell,J., Iturralde,G., Yip,E.C., Powers,K.S. & Bukowski,T.C. 2007. Natural history miscellany - Altitudinal patterns of spider sociality and the biology of a new midelevation social *Anelosimus* species in Ecuador. *American Naturalist* 170, 783-792.
- Bauwens,D., Garland,T., Castilla,A.M. & Vandamme,R. 1995. Evolution of Sprint Speed in Lacertid Lizards - Morphological, Physiological, and Behavioral Covariation. *Evolution* 49, 848-863.
- Berwaerts,K., Aerts,P. & Van Dyck,H. 2006. On the sex-specific mechanisms of butterfly flight: flight performance relative to flight morphology, wing kinematics, and sex in *Pararge aegeria*. *Biological Journal of the Linnean Society* 89, 675-687.
- Bilde,T., Lubin,Y., Smith,D., Schneider,J.M. & Maklakov,A.A. 2005. The transition to social inbred mating systems in spiders: role of inbreeding tolerance in a subsocial predecessor. *Evolution* 59, 160-174.
- Bilde,T., Coates,K.S., Birkhofer,K., Bird,T., Maklakov,A.A., Lubin,Y. & Aviles,L. 2007. Survival benefits select for group living in a social spider despite reproductive costs. *J. Evol. Biol.* 20, 2412-2426.

- Billerbeck, J.M., Lankford, T.E. & Conover, D.O. 2001. Evolution of intrinsic growth and energy acquisition rates. I. Trade-offs with swimming performance in *Menidia menidia*. *Evolution* 55, 1863-1872.
- Birkhead, T.R. & Moller, A.P. 1992. *Sperm Competition in Birds: Evolutionary Causes and Consequences*. London: Academic Press.
- Birkhead, T.R. & Moller, A.P. 1998. *Sperm Competition and Sexual Selection*. San Diego: Academic Press.
- Blackledge, T.A., Swindeman, J.E. & Hayashi, C.Y. 2006. Quasistatic and continuous dynamic characterization of the mechanical properties of silk from the cobweb of the black widow spider *Latrodectus hesperus*. *The Journal of Experimental Biology* 208, 1937-1949.
- Blackledge, T.A. & Zevenbergen, J.M. 2007. Condition-dependent spider web architecture in the western black widow, *Latrodectus hesperus*. *Animal Behaviour* 73, 855-864.
- Blanckenhorn, W.U. 2000. The evolution of body size: What keeps organisms small? *Quarterly Review of Biology* 75, 385-407.
- Blanckenhorn, W.U. 2005. Behavioral causes and consequences of sexual size dimorphism. *Ethology* 111, 977-1016.
- Bonte, D., De Clercq, N., Zwertvaegher, I. & Lens, L. 2009. Repeatability of dispersal behaviour in a common dwarf spider: evidence for different mechanisms behind short- and long-distance dispersal. *Ecological Entomology* 34, 271-276.
- Brandt, Y. & Andrade, M.C.B. 2007a. Testing the gravity hypothesis of sexual size dimorphism: are small males faster climbers? *Functional Ecology* 21, 379-385.
- Brandt, Y. & Andrade, M.C.B. 2007b. What is the matter with the gravity hypothesis? *Functional Ecology* 21, 1182-1183.
- Calsbeek, R. 2008. An ecological twist on the morphology-performance-fitness axis. *Evolutionary Ecology Research* 10, 197-212.
- Calsbeek, R. & Irschick, D.J. 2007. The quick and the dead: Correlational selection on morphology, performance, and habitat use in island lizards. *Evolution* 61, 2493-2503.

- Choe,J. & Crespi,B. 1997. *The Evolution of Mating Systems in Insects and Arachnids*. Cambridge: Cambridge University Press.
- Coddington,J.A., Hormiga,G. & Scharff,N. 1997. Giant female or dwarf male spiders? *Nature* 385, 687-688.
- Coslovsky,M. & Zschokke,S. 2009. Asymmetry in Orb-Webs: An Adaptation to Web Building Costs? *Journal of Insect Behavior* 22, 29-38.
- Craig,C.L., Riekel,C., Herbestein,M.E., Weber,R.S., Kaplan,D. & Pierce,N.E. 2000. Evidence for Diet Effects on the Composition of Silk Proteins Produced by Spiders. *Mol. Biol. Evol.* 17, 1904-1913.
- Darwin,C. 1859. *The Origin of Species by Means of Natural Selection*. London: John Murray.
- Darwin,C. 1871. *The Descent of Man, and Selection in Relation to Sex*. London: John Murray.
- De Mas,E., Ribera,C. & Moya-Laraño,J. 2009. Resurrecting the differential mortality model of sexual size dimorphism. *Journal of Evolutionary Biology* 22, 1739-1749.
- Eberhard,W.G. 1996. *Female Control: Sexual Selection by Cryptic Female Choice*. Princeton, N.J.: Princeton University Press.
- Elgar,M.A. 1992. Sexual cannibalism in spiders and other invertebrates. In: *Cannibalisms: Ecology and Evolution Among Diverse Taxa* (Ed. by M.A.Elgar & B.Crespi), pp. 128-155. Oxford, Oxford University Press.
- Enders,F. 1976. Size, Food-Finding, and Dyars Constant. *Environmental Entomology* 5, 1-10.
- Fairbairn,D.J. 1997. Allometry for sexual size dimorphism: Pattern and process in the coevolution of body size in males and females. *Annual review of ecology and systematics* 28, 659-687.
- Fairbairn,D.J. 2007. Introduction: the enigma of sexual size dimorphism. In: *Sex, Size & Gender Roles: Evolutionary Studies of Sexual Size Dimorphism*, pp. 1-10. New York, Oxford University Press.

- Fairbairn,D.J., Blanckenhorn,W.U. & Székely,T. 2007. *Sex, Size & Gender Roles: Evolutionary Studies of Sexual Size Dimorphism*. New York: Oxford University Press.
- Felsenstein,J. 1985. Phylogenies and the Comparative Method. *American Naturalist* 125, 1-15.
- Fernandez-Montraveta,C., Lahozbeltra,R. & Ortega,J. 1991. Spatial-distribution of *Lycosa tarantula fasciiventris* (Araneae, Lycosidae) in a population from central Spain. *Journal of Arachnology* 19, 73-79.
- Fernandez-Montraveta,C. & Ortega,J. 1993. Sex differences in the agonistic behaviour of a lycosid spider (Araneae Lycosidae). *Ethology Ecology & Evolution* 5, 293-301.
- Fernandez-Montraveta,C. & Ruano-Bellido,J. 2000. Female silk and mate attraction in a burrowing wolf-spider (Araneae, Lycosidae). *Bulletin of the British Arachnological Society* 11, 361-366.
- Fernandez-Montraveta,C. & Cuadrado,M. 2003. Timing and patterns of mating in a free-ranging population of *Lycosa tarantula* (Araneae, Lycosidae) from central Spain. *Canadian Journal of Zoology-Revue Canadienne de Zoologie* 81, 552-555.
- Fernandez-Montraveta,C. & Cuadrado,M. 2009. Mate Attraction in a Burrowing Wolf-Spider (Araneae, Lycosidae) is not Olfactory Mediated. *Ethology* 115, 375-383.
- Fish,F.E. & Nicastró,A.J. 2003. Aquatic turning performance by the whirligig beetle: constraints on maneuverability by a rigid biological system. *Journal of Experimental Biology* 206, 1649-1656.
- Foelix,R.F. 1996. *Biology of Spiders*. 2<sup>nd</sup> edn. Oxford: Oxford University Press.
- Foellmer,M.W. & Fairbairn,D.J. 2005a. Competing dwarf males: sexual selection in an orb-weaving spider. *Journal of Evolutionary Biology* 18, 629-641.
- Foellmer,M.W. & Fairbairn,D.J. 2005b. Selection on male size, leg length and condition during mate search in a sexually highly dimorphic orb-weaving spider. *Oecologia* 142, 653-662.

- Foellmer, M.W. & Moya-Laraño, J. 2007. Sexual Size Dimorphism in Spiders. In: *Sex, Size & Gender Roles. Evolutionary Studies of Sexual Size Dimorphism* (Ed. by D.J. Fairbairn, W.U. Blanckenhorn & T. Székely), pp. 71-81. New York, Oxford University Press.
- Framenau, V.W. 2005. Gender specific differences in activity and home range reflect morphological dimorphism in wolf spiders (Araneae, Lycosidae). *Journal of Arachnology* 33, 334-346.
- Full, R.J. & Tu, M.S. 1990. Mechanics of 6-Legged Runners. *Journal of Experimental Biology* 148, 129-146.
- Full, R.J. & Tullis, A. 1990. Energetics of Ascent - Insects on Inclines. *Journal of Experimental Biology* 149, 307-317.
- Garland, T.Jr., Bennett, A.F. & Rezende, E.L. 2005. Phylogenetic approaches in comparative physiology. *Journal of Experimental Biology* 208, 3015-3035.
- Garland, T.Jr. & Freeman, P.W. 2005. Selective breeding for high endurance running increases hindlimb symmetry. *Evolution* 59, 1851-1854.
- Ghiselin, M. 1974. *The Economy of Nature and the Evolution of Sex*. Berkeley: University of California Press.
- Gomendio, M., Martín-Coello, J., Crespo, C., Magaña, C. & Roldán, E.R.S. 2006. Sperm competition enhances functional capacity of mammalian spermatozoa. *Proceedings of the National Academy of Sciences of the United States of America* 103, 15113-15117.
- Hanks, L.M., Millar, J.G. & Paine, T.D. 1996. Mating behavior of the eucalyptus longhorned borer (Coleoptera: Cerambycidae) and the adaptive significance of long "horns". *Journal of Insect Behavior* 9, 383-393.
- Head, G. 1995. Selection on Fecundity and Variation in the Degree of Sexual Size Dimorphism Among Spider Species (Class Araneae). *Evolution* 49, 776-781.
- Henschel, J.R., Schneider, J. & Lubin, Y.D. 1995. Dispersal mechanisms of Stegodyphus (Eresidae): Do they balloon? *Journal of Arachnology* 23, 202-204.

- Hormiga,G., Scharff,N. & Coddington,J.A. 2000. The phylogenetic basis of sexual size dimorphism in orb-weaving spiders (Araneae, Orbiculariae). *Systematic Biology* 49, 435-462.
- Huber,B.A. 2005. Sexual selection research on spiders: progress and biases. *Biological Reviews* 80, 363-385.
- Husak,J.F. & Fox,S.F. 2006. Field use of maximal sprint speed by collared lizards (*Crotaphytus collaris*): Compensation and sexual selection. *Evolution* 60, 1888-1895.
- Husak,J.F., Fox,S.F., Lovern,M.B. & Van Den Bussche,R.A. 2006. Faster lizards sire more offspring: Sexual selection on whole-animal performance. *Evolution* 60, 2122-2130.
- Husak,J.F. & Fox,S.F. 2008. Sexual selection on locomotor performance. *Evolutionary Ecology Research* 10, 213-228.
- Husak,J.F., Fox,S.F. & Van Den Bussche,R.A. 2008. Faster male lizards are better defenders not sneakers. *Animal Behaviour* 75, 1725-1730.
- Iriarte-Diaz,J. 2002. Differential scaling of locomotor performance in small and large terrestrial mammals. *Journal of Experimental Biology* 205, 2897-2908.
- Irschick,D.J. 2003. Measuring performance in nature: Implications for studies of fitness within populations. *Integrative and Comparative Biology* 43, 396-407.
- Irschick,D.J., Meyers,J.J., Husak,J.F. & Le Galliard,J.F. 2008. How does selection operate on whole-organism functional performance capacities? A review and synthesis. *Evolutionary Ecology Research* 10, 177-196.
- Jayne,B.C. & Bennett,A.F. 1990. Scaling of Speed and Endurance in Garter Snakes - A Comparison of Cross-Sectional and Longitudinal Allometries. *Journal of Zoology* 220, 257-277.
- Johannesen,J., Baumann,T., Seitz,A. & Veith,M. 1998. The significance of relatedness and gene flow on population genetic structure in the subsocial spider *Eresus cinnaberinus* (Araneae : Eresidae). *Biological Journal of the Linnean Society* 63, 81-98.



- Johannesen, J. & Lubin, Y. 1999. Group founding and breeding structure in the subsocial spider *Stegodyphus lineatus* (Eresidae). *Heredity* 82, 677-686.
- Johannesen, J. & Lubin, Y. 2001. Evidence for kin-structured group founding and limited juvenile dispersal in the sub-social spider *Stegodyphus lineatus* (Araneae, Eresidae). *Journal of Arachnology* 29, 413-422.
- Johannesen, J., Hennig, A., Dommermuth, B. & Schneider, J.M. 2002. Mitochondrial DNA distributions indicate colony propagation by single matri-lineages in the social spider *Stegodyphus dumicola* (Eresidae). *Biological Journal of the Linnean Society* 76, 591-600.
- Johannesen, J., Lubin, Y., Smith, D.R., Bilde, T. & Schneider, J.M. 2007. The age and evolution of sociality in *Stegodyphus* spiders: a molecular phylogenetic perspective. *Proceedings of the Royal Society B-Biological Sciences* 274, 231-237.
- Johannesen, J., Wickler, W., Seibt, U. & Moritz, R.F.A. 2009. Population history in social spiders repeated: colony structure and lineage evolution in *Stegodyphus mimosarum* (Eresidae). *Molecular Ecology* 18, 2812-2818.
- Johansson, F., Lederer, B. & Lind, M.I. 2010. Trait Performance Correlations across Life Stages under Environmental Stress Conditions in the Common Frog, *Rana temporaria*. *PLoS ONE* 5.
- Johnson, M.L. & Gaines, M.S. 1990. Evolution of Dispersal - Theoretical-Models and Empirical Tests Using Birds and Mammals. *Annual review of ecology and systematics* 21, 449-480.
- Jones, T.C., Riechert, S.E., Dalrymple, S.E. & Parker, P.G. 2007. Fostering model explains variation in levels of sociality in a spider system. *Animal Behaviour* 73, 195-204.
- Kabat, A.P., Phillips, R.A., Croxall, J.P. & Butler, P.J. 2007. Differences in metabolic costs of terrestrial mobility in two closely related species of albatross. *Journal of Experimental Biology* 210, 2851-2858.

- Kelly,C.D., Bussiere,L.F. & Gwynne,D.T. 2008. Sexual selection for male mobility in a giant insect with female-biased size dimorphism. *American Naturalist* 172, 417-423.
- Kotiaho,J.S., Alatalo,R.V., Mappes,J., Nielsen,M.G., Parri,S. & Rivero,A. 1998. Energetic costs of size and sexual signalling in a wolf spider. *Proceedings of the Royal Society of London Series B-Biological Sciences* 265, 2203-2209.
- Kraus,O. & Kraus,M. 1988. The genus *Stegodyphus* (Arachnida, Araneae). Sibling species, species groups, and parallel origin of social living. *Verhandlungen des Naturwissenschaftlichen Vereins in Hamburg* 30.
- Lande,R. & Arnold,S.J. 1983. The Measurement of Selection on Correlated Characters. *Evolution* 37, 1210-1226.
- Legrand,R.S. & Morse,D.H. 2000. Factors driving extreme sexual size dimorphism of a sit-and-wait predator under low density. *Biological Journal of the Linnean Society* 71, 643-664.
- Li,D. & Kuan,J.Y.X. 2006. Natal dispersal and breeding dispersal of a subsocial spitting spider (*Scytodes pallida*) (Araneae : Scytodidae), from Singapore. *Journal of Zoology* 268, 121-126.
- Linn,C.D. 2001. The Effect of Male Size on Travel Ability in the Golden Orb-Weaving Spider *Nephila Clavipes*: Implications for Sexual Size Dimorphism. Department of Psychology. Tulane University.
- Lipp,A., Wolf,H. & Lehmann,F.O. 2005. Walking on inclines: energetics of locomotion in the ant *Camponotus*. *Journal of Experimental Biology* 208, 707-719.
- Lloyd,N.J. & Elgar,M.A. 1997. Costs and benefits of facultative aggregating behaviour in the orb-spinning spider *Gasteracantha minax* Thorell (Araneae: Araneidae). *Australian Journal of Ecology* 22, 256-261.
- Losos,J.B. 1990. Ecomorphology, Performance Capability, and Scaling of West-Indian *Anolis* Lizards - An Evolutionary Analysis. *Ecological Monographs* 60, 369-388.
- Losos,J.B., Mouton,P.L.N., Bickel,R., Cornelius,I. & Ruddock,L. 2002. The effect of body armature on escape behaviour in cordylid lizards. *Animal Behaviour* 64, 313-321.

- Lubin,Y. & Bilde,T. 2007. The evolution of sociality in spiders. *Advances in the Study of Behavior, Vol 37* 37, 83-145.
- Lubin,Y., Birkhofer,K., Berger-Tal,R. & Bilde,T. 2009. Limited male dispersal in a social spider with extreme inbreeding. *Biological Journal of the Linnean Society* 97, 227-234.
- Marshall,S.D. 1995. Mechanisms of the formation of territorial aggregations of the burrowing wolf spider *Geolycosa xera archboldi* McCrone (Araneae, Lycosidae). *Journal of Arachnology* 23, 145-150.
- Miles,D.B. 2004. The race goes to the swift: fitness consequences of variation in sprint performance in juvenile lizards. *Evolutionary Ecology Research* 6, 63-75.
- Morse,D.H. & Fritz,R.S. 1982. Experimental and Observational Studies of Patch Choice at Different Scales by the Crab Spider *Misumena-Vatia*. *Ecology* 63, 172-182.
- Moya-Laraño,J., Halaj,J. & Wise,D.H. 2002. Climbing to reach females: Romeo should be small. *Evolution* 56, 420-425.
- Moya-Laraño,J., Pascual,J. & Wise,D.H. 2003. Mating patterns in late-maturing female Mediterranean tarantulas may reflect the costs and benefits of sexual cannibalism. *Animal Behaviour* 66, 469-476.
- Moya-Laraño,J., Pascual,J. & Wise,D.H. 2004. Approach strategy by which male Mediterranean tarantulas adjust to the cannibalistic behaviour of females. *Ethology* 110, 717-724.
- Moya-Laraño,J., El Sayyid,M.E.T. & Fox,C.W. 2007a. Smaller beetles are better scramble competitors at cooler temperatures. *Biology Letters* 3, 475-478.
- Moya-Laraño,J., Vinkovic,D., Allard,C.M. & Foellmer,M.W. 2007b. Mass-mediated sex differences in climbing patterns support the gravity hypothesis of sexual size dimorphism. *Web Ecology* 7, 106-112.
- Moya-Laraño,J., Vinkovic,D., Allard,C. & Foellmer,M. 2007c. Gravity still matters. *Functional Ecology* 21, 1178-1181.

- Moya-Laraño,J., Vinkovic,D., Allard,C.M. & Foellmer,M.W. 2009. Optimal climbing speed explains the evolution of extreme sexual size dimorphism in spiders. *J. Evol. Biol.* 22, 954-963.
- Opell,B.D. 1998. Economics of spider orb-webs: the benefits of producing adhesive capture thread and of recycling silk. *Functional Ecology* 12, 613-624.
- Partridge,L., Ewing,A. & Chandler,A. 1987. Male Size and Mating Success in *Drosophila-Melanogaster* - the Roles of Male and Female Behavior. *Animal Behaviour* 35, 555-562.
- Peters,H.M. 1990. On the structure and glandular origin of bridging lines used by spiders for moving to distant places. *Acta Zoologica Fennica* 190, 309-314.
- Peters,R.H. 1983. *The Ecological Implications of Body Size*. Cambridge: Cambridge Univ Press.
- Platnick,N.I. The World Spider Catalog, Version 11.5. 2011. Am. Mus. Nat. Hist.
- Post,W. & Greenlaw,J.S. 1982. Comparative Costs of Promiscuity and Monogamy - A Test of Reproductive Effort Theory. *Behavioral Ecology and Sociobiology* 10, 101-107.
- Prenter,J., Elwood,R.W. & Montgomery,W.I. 1999. Sexual size dimorphism and reproductive investment by female spiders: A comparative analysis. *Evolution* 53, 1987-1994.
- Prenter,J., Perez-Staples,D. & Taylor,P.W. 2010. The effects of morphology and substrate diameter on climbing and locomotor performance in male spiders. *Functional Ecology* 24, 400-408.
- Pruitt,J.N. 2010. Differential selection on sprint speed and ad libitum feeding behaviour in active vs. sit-and-wait foraging spiders. *Functional Ecology* 24, 392-399.
- Pruitt,J.N. & Husak,J.F. 2010. Context-dependent running speed in funnel-web spiders from divergent populations. *Functional Ecology* 24, 165-171.
- Pruitt,J.N. & Troupe,J.E. 2010. The effect of reproductive status and situation on locomotor performance and anti-predator strategies in a funnel-web spider. *Journal of Zoology* 281, 39-45.

- Purcell,J. & Aviles,L. 2007. Smaller colonies and more solitary living mark higher elevation populations of a social spider. *Journal of Animal Ecology* 76, 590-597.
- Purcell,J. & Aviles,L. 2008. Gradients of precipitation and ant abundance may contribute to the altitudinal range limit of subsocial spiders: insights from a transplant experiment. *Proceedings of the Royal Society B-Biological Sciences* 275, 2617-2625.
- Raihani,G., Szekely,T., Serrano-Meneses,M.A., Pitra,C. & Goriup,P. 2006. The influence of sexual selection and male agility on sexual size dimorphism in bustards (Otididae). *Animal Behaviour* 71, 833-838.
- Ramos,M., Coddington,J.A., Christenson,T.E. & Irschick,D.J. 2005. Have male and female genitalia coevolved? A phylogenetic analysis of genitalic morphology and sexual size dimorphism in web-building spiders (Araneae : Araneoidea). *Evolution* 59, 1989-1999.
- Reiss,M. 1989. *The Allometry of Growth and Reproduction*. Cambridge: Cambridge University Press.
- Riechert,S.E. 1974. Pattern of Local Web Distribution in A Desert Spider - Mechanisms and Seasonal-Variation. *Journal of Animal Ecology* 43, 733-746.
- Roff,D.A. 1991. Life-History Consequences of Bioenergetic and Biomechanical Constraints on Migration. *American Zoologist* 31, 205-215.
- Roff,D.A. 2000. Trade-offs between growth and reproduction: an analysis of the quantitative genetic evidence. *Journal of Evolutionary Biology* 13, 434-445.
- Roff,D.A. 2002. *Life History Evolution*. Sunderland, MA: Sinauer Associates.
- Savalli,U.M. 2001. Sexual Selection. In: *Evolutionary Ecology: Concepts and Case Studies* (Ed. by C.W.Fox, D.A.Roff & D.J.Fairbairn), pp. 207-221. New York, Oxford University Press.
- Schmitt,J. & Holmes,P. 2001. Mechanical models for insect locomotion: stability and parameter studies. *Physica D-Nonlinear Phenomena* 156, 139-168.
- Schmitt,J., Garcia,M., Razo,R.C., Holmes,P. & Full,R.J. 2002. Dynamics and stability of legged locomotion in the horizontal plane: a test case using insects. *Biological Cybernetics* 86, 343-353.

- Schneider, J.M., Roos, J., Lubin, Y. & Henschel, J.R. 2001. Dispersal of *Stegodyphus dumicola* (Araneae, Eresidae): They do balloon after all! *Journal of Arachnology* 29, 114-116.
- Schutz, D. & Taborsky, M. 2005. Mate choice and sexual conflict in the size dimorphic water spider *Argyroneta aquatica* (Araneae, Argyronetidae). *Journal of Arachnology* 33, 767-775.
- Schwagmeyer, P.L. 1988. Scramble-Competition Polygyny in An Asocial Mammal - Male Mobility and Mating Success. *American Naturalist* 131, 885-892.
- Smith, D., van Rijn, S., Henschel, J., Bilde, T. & Lubin, Y. 2009. Amplified fragment length polymorphism fingerprints support limited gene flow among social spider populations. *Biological Journal of the Linnean Society* 97, 235-246.
- Smith, H.M. 2009. The costs of moving for a diurnally cryptic araneid spider. *Journal of Arachnology* 37, 84-91.
- Swanson, B.O., Blackledge, T.A., Bertrán, J. & Hayashi, C.Y. 2006. Variation in the material properties of spider dragline silk across species. *Applied Physics A - Materials Science & Processing* 82, 213-218.
- Swartz, S.M. 1989. Pendular Mechanics and the Kinematics and Energetics of Brachiating Locomotion. *International Journal of Primatology* 10, 387-418.
- Székely, T. 2007. Section I. Macro-patterns: explaining broad-scale patterns of variation in sexual size dimorphism. Introduction. In: *Sex, Size & Gender Roles: Evolutionary Studies of Sexual Size Dimorphism*, pp. 13-15. New York, Oxford University Press.
- Thornhill, R. & Alcock, J. 1983. *The Evolution of Insect Mating Systems*. Harvard, Mass: Harvard University Press.
- Torres-Contreras, H. & Vasquez, R.A. 2007. Spatial heterogeneity and nestmate encounters affect locomotion and foraging success in the ant *Dorymyrmex goetschi*. *Ethology* 113, 76-86.
- Trivers, R. 1972. Parental investment and sexual selection. In: *Sexual Selection and the Descent of Man, 1871-1971* (Ed. by B.Campbell), pp. 136-179. Chicago, Aldine.

- Viera,C., Ghione,S. & Costa,F.G. 2006. Regurgitation among penultimate juveniles in the subsocial spider *Anelosimus cf. studiosus* (Theridiidae): are males favored? *Journal of Arachnology* 34.
- Vollrath,F. 1982. Colony foundation in a social spider. *Zeitschrift für Tierpsychologie* 60, 313-324.
- Vollrath,F. & Parker,G.A. 1992. Sexual Dimorphism and Distorted Sex-Ratios in Spiders. *Nature* 360, 156-159.
- Vollrath,F. 1998. Dwarf males. *Trends in Ecology & Evolution* 13, 159-163.
- Walker,S.E. & Rypstra,A.L. 2003. Sexual dimorphism and the differential mortality model: is behaviour related to survival? *Biological Journal of the Linnean Society* 78, 97-103.
- Wells,K.D. 1977. Social-Behavior of Anuran Amphibians. *Animal Behaviour* 25, 666-693.
- Whitehouse,M.E.A. & Lubin,Y. 2005. The functions of societies and the evolution of group living: spider societies as a test case. *Biological Reviews* 80, 347-361.
- Wise,D.H. 1993. *Spiders in Ecological Webs*. New York: Cambridge University Press.





# MANUSCRITOS



# MANUSCRIPT I

## Morphological evolution of spiders predicted by pendulum mechanics

Jordi Moya-Laraño<sup>1\*</sup>, Dejan Vinković<sup>2</sup>, Eva De Mas<sup>1</sup>, Guadalupe Corcobado<sup>1</sup> and Eulalia Moreno<sup>1</sup>

<sup>1</sup>Dpto. de Ecología Funcional y Evolutiva, Estación Experimental de Zonas Áridas, CSIC, General Segura, 1, 04001-Almería, Almería, Spain.

<sup>2</sup>Physics department, University of Split, N. Tesle 12, 21000 Split, Croatia.



*PLoS ONE* 2008, 3(3): e1841. doi:10.1371

## Resumen

**Antecedentes.** Se ha hipotetizado que los animales podrían beneficiarse de la mecánica pendular cuando se desplazan colgados por sus extremidades, ya que la energía potencial de la gravedad se convertiría en energía cinética de acuerdo con el principio de conservación de la energía. Sin embargo, hasta la fecha, no se han encontrado pruebas convincentes. Demostrar que la evolución de la forma de los individuos ha seguido la mecánica pendular es importante desde un punto de vista biomecánico puesto que durante el tipo de locomoción que tiene lugar con los individuos colgados por sus extremidades, algunos rasgos morfológicos podrían haberse desacoplado de la gravedad, permitiendo así la evolución morfológica adaptativa independiente de estos caracteres en comparación con animales que se desplazan caminando sobre sus patas; es decir, como péndulos invertidos. Si la evolución de la forma corporal se ajusta a la mecánica pendular simple, en los animales que se mueven con sus cuerpos suspendidos deberían evolucionar patas relativamente más largas, lo cual debe conferir mayor capacidad para desplazarse.

**Metodología/Principales resultados.** Se testó esta hipótesis en arañas, un grupo diverso de depredadores generalistas terrestres, donde el tipo de locomoción consistente en desplazarse colgado por las extremidades se ha ganado y perdido varias veces independientemente a lo largo de la historia evolutiva. En arañas que cuelgan boca-arriba de sus telas, han evolucionado patas desproporcionadamente más largas en relación a su tamaño corporal, en comparación con arañas que se mueven caminando sobre sus patas. Además, se encontró que tener patas desproporcionadamente más largas permitía a las arañas moverse más rápido cuando se desplazaban colgadas boca-abajo de sus extremidades, mientras que estas mismas arañas corrían a una velocidad más lenta sobre el suelo (es decir, como péndulos invertidos). Finalmente, cuando las arañas que habitualmente se desplazan colgadas de sus extremidades eran inducidas a correr sobre el suelo, hay una clara tendencia según la cual las arañas más grandes tienden a correr mucho más lentamente que otras especies de arañas de similar tamaño pero que habitualmente se desplazan como péndulos invertidos (es decir, arañas errantes o *wandering spiders* en inglés).

**Conclusiones.** Varias líneas de evidencias apoyan la hipótesis de que las arañas han evolucionado de acuerdo con las predicciones de la mecánica pendular. Estos descubrimientos tienen potencialmente importantes implicaciones ecológicas y evolutivas puesto que podrían explicar parcialmente la existencia de plasticidad fenotípica y restricciones en la dispersión, así como la evolución del dimorfismo sexual en el tamaño y la sociabilidad.

## Abstract

**Background.** Animals have been hypothesized to benefit from pendulum mechanics during suspensory locomotion, in which the potential energy of gravity is converted into kinetic energy according to the energy-conservation principle. However, no convincing evidence has been found so far. Demonstrating that morphological evolution follows pendulum mechanics is important from a biomechanical point of view because during suspensory locomotion some morphological traits could be decoupled from gravity, thus allowing independent adaptive morphological evolution of these two traits when compared to animals that move standing on their legs; i.e., as inverted pendulums. If the evolution of body shape matches simple pendulum mechanics, animals that move suspending their bodies should evolve relatively longer legs which must confer high moving capabilities.

**Methodology/Principal Findings.** We tested this hypothesis in spiders, a group of diverse terrestrial generalist predators in which suspensory locomotion has been lost and gained a few times independently during their evolutionary history. In spiders that hang upside-down from their webs, their legs have evolved disproportionately longer relative to their body sizes when compared to spiders that move standing on their legs. In addition, we show how disproportionately longer legs allow spiders to run faster during suspensory locomotion and how these same spiders run at a slower speed on the ground (i.e., as inverted pendulums). Finally, when suspensory spiders are induced to run on the ground, there is a clear trend in which larger suspensory spiders tend to run much more slowly than similar-size spiders that normally move as inverted pendulums (i.e., wandering spiders).

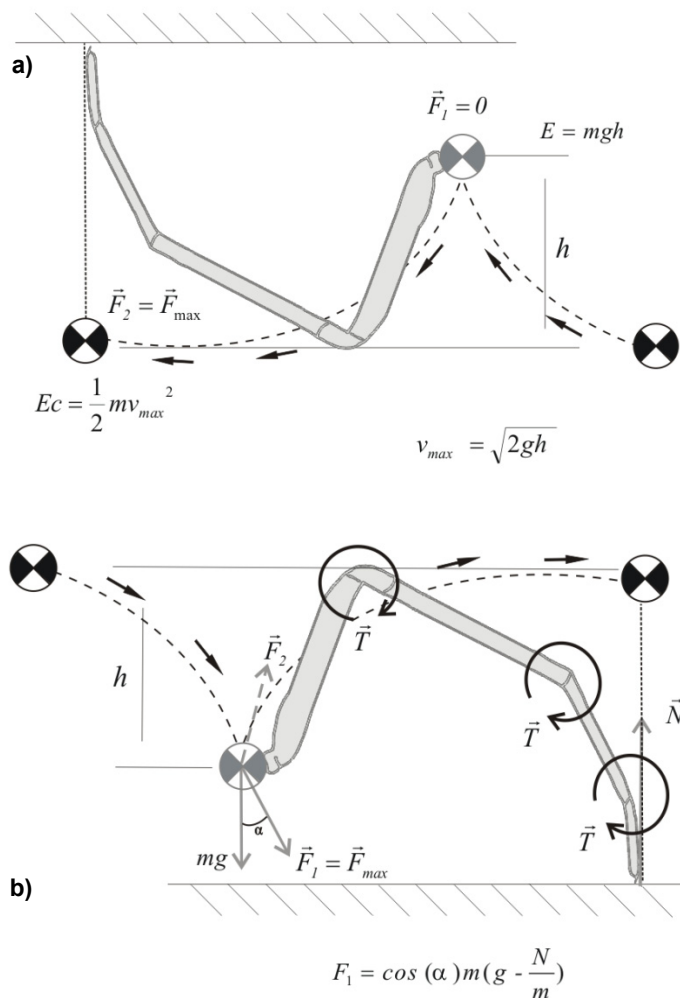
**Conclusions/Significance.** Several lines of evidence support the hypothesis that spiders have evolved according to the predictions of pendulum mechanics. These findings have potentially important ecological and evolutionary implications since they could partially explain the occurrence of foraging plasticity and dispersal constraints as well as the evolution of sexual size dimorphism and sociality.

## Introduction

Understanding the relationship between form and function in organisms may increase our knowledge about natural processes, especially when it comes to reveal how physical laws apply to the adaptive design of organisms. The mode of locomotion plays a major role in the evolution of many morphological traits, since these traits affect several fitness components through behavioural performance (Arnold 1983). In most terrestrial animals, the most common mode of locomotion is standing on their legs on horizontal surfaces, by which these animals can walk, trot, run or even jump. To climb on vertical surfaces or to hang from branches are specialized locomotion modes which may have evolved as adaptations to a particular habitat or microhabitat use, and specialized morphological traits are generally associated with them (Swartz 1989; Moreno & Carrascal 1993; Hallgrímsson & Swartz 1995; Foellmer & Moya-Laraño 2007).

From a biomechanical standpoint, morphological specialization for upside-down walking is a fortuitous case for studying basic walking mechanisms because it enables the decoupling of morphological components when compared with horizontal walking. This means that, since normal walking is similar to an inverted pendulum (Dickinson et al. 2000; Alexander 2003; Srinivasan & Ruina 2006), the torques and the energy necessary to lift the body constrain how thick or long legs can be (Fig. 1), a situation that does not occur during upside-down walking (thus the decoupling of morphological components). The basic model of horizontal motion is an inverted pendulum where leg muscles keep the pendulum oscillating in the inverted position (Dickinson et al. 2000; Alexander 2003; Srinivasan & Ruina 2006). On the other hand, upside-down walking can exploit the properties of a normal pendulum and, in an ideal case, requires little muscle to move the body centre of masses (BCM) steadily forward (Gomes & Ruina 2005). Mechanical power of upside-down walking can be, at least partially, obtained from converting the gravitational potential energy into kinetic energy for moving forward, as a pendulum does during oscillation (Fig. 1). Therefore, since body mass does not constrain as much the

evolution of leg traits, selection can act on leg traits, such as stride frequency (leg diameter) and stride length (leg length). Thus, if animals have evolved following the physics of pendulums, we should see that the body shape of animals that move mostly standing on their legs (standing animals) and those that mostly move suspending their bodies (hanging animals) differ in a manner consistent with pendulum movement and that these differences explain the moving abilities in each context.



**Figure 1. How pendulum mechanics drives the evolution of spider legs.** Dashed lines depict the trajectories of the Body Center of Masses (BCM) following the trajectories of pendulums. **a) Hanging spiders: normal pendulums.** The vertical distance between the highest and the lowest point of a pendulum ( $h$ ) determines the amount of potential energy at the highest point which is converted into kinetic energy at the lowest point. The maximum force,  $F_2$  (and maximum speed of the BCM) occurs at the lowest (middle) point of a pendulum stride. Therefore, if spiders move like pendulums during suspensory locomotion, natural selection should favour longer legs. **b) Standing spiders: inverted pendulums.** When spiders move as inverted pendulums, they have to change the direction of the BCM between steps. Here, the maximum force  $F_1$  occurs at the end of each step and this force depends on body mass. Thus, the larger the spider the larger the forces ( $T$  and  $N$ ) necessary to change the direction of force  $F_1$  to  $F_2$ . As a consequence, as body size increases the maximum attainable leg length is constrained in order to keep  $N$  and  $T$  sufficiently large to re-direct  $F_1$ . In contrast, in (A), most of the force for the next stride comes from gravity.

Suspensory locomotion has been studied mostly in primates (Swartz 1989; Hallgrímsson & Swartz 1995; Bertram et al. 1999; Gomes & Ruina 2005) and it has been argued that during brachiation, gibbons and siamang move somehow taking advantage of pendulum oscillatory mechanics, thus saving a substantial amount of energy during locomotion (Swartz 1989). However, it is not clear whether this mode

of locomotion is cheaper than walking and running on the ground, and also whether body shape in these primates entails an adaptation conforming to pendulum mechanics (Swartz 1989; Hallgrímsson & Swartz 1995; Bertram et al. 1999; Gomes & Ruina 2005). In particular, following simple pendulum mechanics longer forelimbs should enhance the maximum speed attainable (Fig. 1), and thus an important prediction is that if leg length is the target of natural selection, hanging animals must have evolved disproportionately longer legs relative to their body size when compared with animals that walk standing on their legs. Since leg length enhances velocity via longer stride lengths (Bauwens et al. 1995; Framenau 2005), we also expect legs in standing animals to grow disproportionately longer with body size. In addition, in standing animals longer legs allow to have the BCM higher above the ground, which will also provide more inertia to help the animal move forward (Alexander 2003). However, due to the constraints outlined above (Fig. 1) we should expect the net benefit to be smaller than in hanging animals.

The spiders (Araeneae) are a highly diverse group of terrestrial predators (Wise 1993; Foelix 1996) that are exceptional organisms to test evolutionary hypotheses about pendulum mechanics because in this group living upside-down (i.e., hanging from their webs) or living standing on their legs (i.e., on top of their webs or wandering around) has been lost and gained independently a few times during spider evolution (Fig. S1) (Kaston 1981; Jones 1985; Roberts 1985a; Roberts 1985b; Roberts 1995; Hormiga 2000; Maddison & Hedin 2003; Arnedo et al. 2004; Miller & Hormiga 2004; Coddington 2005; Murphy et al. 2006). Several hanging spiders show a dispersal mode that has been neglected in the literature, bridging (Peters 1990; Ramos et al. 2004), which consists in releasing a silk line downwind, tensing the silk line when it attaches to the opposite end of the release point and walking upside down (i.e., hanging from the line) from one end to the other, thus crossing an actual bridge. During bridging (and probably while hunting prey on their webs), hanging spiders move in a way that can be paralleled to brachiating in primates, with the main difference that during bridging the body of the spider (and thus the BCM) is always behind the forelegs. Thus, during bridging most of the mechanical energy for moving should come from the inertia of the BCM acting as a pendulum hanging from a string and in a lesser degree, the forelegs literally pulling the body forward. Thus, we investigate here whether the shape and the relationship



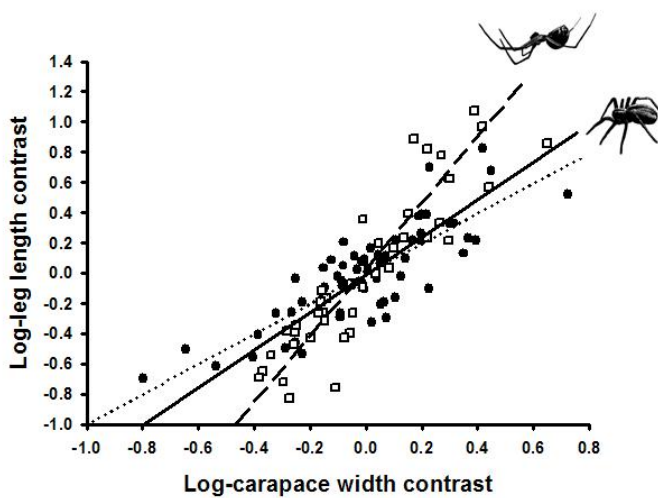
of shape with performance are consistent with what we would expect from pendulum mechanics. Indeed, spiders are likely to move according to pendulums because unlike primates (Swartz 1989; Hallgrímsson & Swartz 1995), spiders do not need strong muscles on the tips of the limbs to resist their mass pulling their body downwards at the lowest point of the pendulum oscillation, since to attach to the silk, spiders use hardened claws that are fused to the exoskeleton (Foelix 1996).

## Results

We found that the shape of spiders matches what we would expect if pendulum mechanics explains the adaptive evolution of spider morphology. Indeed, our results suggest that leg length has been directly favoured by natural selection, since larger spiders that hang from their webs have disproportionately longer forelegs relative to smaller spiders; i.e., positive allometry, and this effect is significantly stronger in these spiders ( $MA_{\text{slope}} = 2.22$ ; 95% CIs: [1.91-2.62]) than in spiders that stand on their legs for most of their lifetime ( $MA_{\text{slope}} = 1.28$ ; 95% CIs: [1.09-1.53]; Fig. 2). These results remained significant even after using a phylogenetically controlled ANCOVA (“posture mode x body size” interaction,  $F_{1,101} = 26.3$ ;  $P = 0.018$ ). Leg diameter scaled isometrically with body size in both groups (hanging,  $MA_{\text{slope}} = 1.06$ ; 95% CIs: [0.89-1.27], standing,  $MA_{\text{slope}} = 1.01$ ; 95% CIs: [0.93-1.11]) and no significant differences were found between groups (phylogenetically controlled ANCOVA: “posture mode x body size” interaction,  $F_{1,101} = 0.91$ ;  $P = 0.608$ ). Thus, consistent with the mechanics of pendulum motion, both standing and hanging spiders have evolved disproportionately longer legs relative to body size, and hanging spiders have done so in a higher degree, as predicted by the constraints imposed on standing spiders (Fig. 1b).

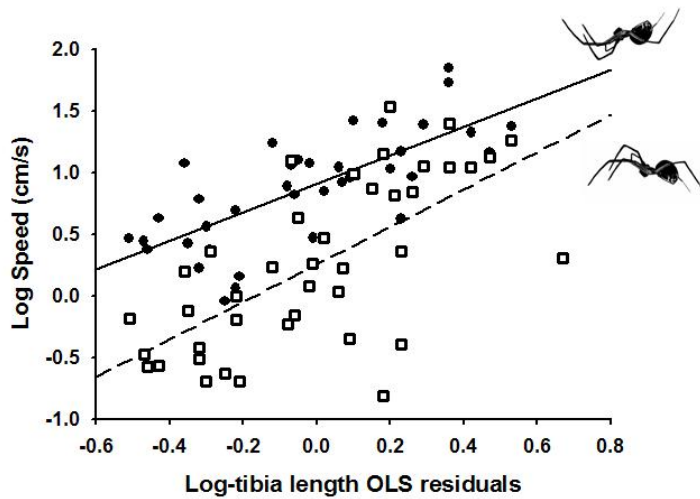
We found evidence that longer legs allow spiders to bridge faster. The hanging spider *Anelosimus aulicus* showed a strong positive ontogenetic allometry of leg length with body size ( $MA_{\text{slope}} = 4.2$ ; 95% CIs: [2.9-7.4]), suggesting that even within the same species, longer legs can also benefit the larger instars relative to the small ones. The OLS residuals of tibia length (controlled for body size) highly (and

positively) explained bridging speed in *A. aulicus* ( $R^2 = 0.54$ ;  $P < 0.0001$ ; Fig. 3), supporting the idea that leg length alone allows faster suspensory movement. The inclusion of carapace width (body size) in a multiple regression model along with the OLS residuals (which remained highly significant –  $b = 1.17$ ;  $P < 0.0001$ ) also significantly and positively explained bridging speed ( $b = 1.05$ ;  $P = 0.005$ ). In addition, we found evidence that the shape of these spiders is more likely an adaptation to move upside-down than to move on flat surfaces. First, the speed at which these spiders run is 1.5X as high when they bridge as when they run on a flat surface (paired t-test,  $t_{36} = 7.4$ ;  $P < 0.0001$ ; Fig. 3). Second, the OLS residuals of leg length were more parsimonious predictors of bridging speed (AIC = 20.8) than of ground-running speed (AIC = 63.0). The combined positive effect of relative leg length and body size could suggest that the allometry of leg length with body size was by itself responsible of the observed pattern. This was confirmed by the use of allometric residuals (i.e., the difference between the observed leg length and the predicted leg length from a perfectly isometric relationship between leg length and carapace width,  $b = 1$ ), which showed a better fit with bridging speed ( $R^2 = 0.63$ ;  $P < 0.0001$ ; AIC = 12.7). Furthermore, their inclusion in a multiple regression along with carapace width predicting bridging speed resulted in a non-significant effect of body size ( $P = 0.411$ ). Thus, both relatively longer legs (OLS residuals) and disproportionately longer legs (allometric residuals) favour greater bridging speed.

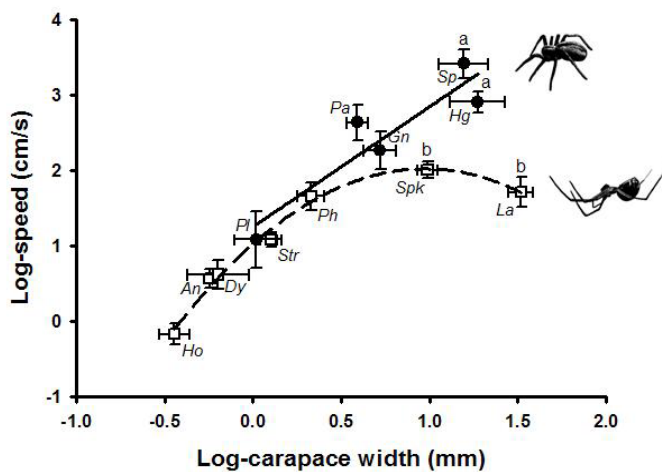


**Figure 2. Scaling of foreleg tibia length with body size in spiders.** Filled circles and solid line: standing spiders; Open squares and dashed line: hanging spiders. The dotted line denotes an isometric relationship (slope = 1). Data points are independent contrasts on the natural logarithms of the original data. See text for statistical analyses.

If spiders that hang their bodies for most of their lifetimes are relatively large, and thus have proportionally very long legs, they should be clumsy runners on the ground (i.e., as inverted pendulums, Fig. 1b). This is because the necessary torques to lift their bodies require either relatively shorter segments (as in normally running spiders) or higher power output from leg muscles. Thus, since leg diameter (and thus muscle power output) has remained constant relative to body size across all body sizes (see above), large spiders adapted to hang upside-down must run at a slower speed than their ground-adapted counterparts. As expected, larger hanging spiders are not efficient runners as inverted pendulums. Beyond a threshold body size, hanging spiders run at a substantially lower speed than spiders of similar size that normally stand on their legs (Fig. 4).



**Figure 3. Relationship between leg length and running performance in the hanging spider *Anelosimus aulicus*.** Solid line and filled circles: bridging underneath a silk line (i.e., pendular motion); Dashed line and open squares: running on the ground (i.e., inverted pendular motion). The x-axis represents OLS residuals, which have been calculated from an OLS regression between the foreleg tibia length and body size (carapace width). See text for statistical analyses.



**Figure 4. The relationship between running performance on the ground and body mass across spider taxa.** Filled circles and solid line: standing spiders; Open squares and dashed line: hanging spiders. Means were obtained across different instars for each spider group. Errors are s.e.m.  $cw$  = carapace width. The fitted model for standing spiders is: ( $\log\_speed = 1.3 + 1.6 * \log\_cw$ ,  $P = 0.025$ ). The fitted model for hanging spiders is: ( $\log\_speed = 1.3 + 2.1 * \log\_cw - 1.1 * \log\_cw^2$ , both regression coefficients  $P < 0.001$ ). Letters on top of bars indicate significant differences between groups according to a Bonferroni-corrected post-hoc Kruskal-Wallis ANOVA test ( $P < 0.05$ ). The letters in italic denote the spider taxa used: *An*, *Anelosimus*; *Dy*, *Dyctinidae*; *Gn*, *Gnaphosidae*; *Hg*, *Hogna*; *Ho*, *Holocnemus*; *La*, *Latrodectus*; *Pa*, *Pardosa*; *Ph*, *Pholcus*; *Pl*, *Philodromidae*; *Sp*, *Sparassidae*; *Spk*, *Steatoda paykulliana*; *Str*, *Steatoda triangulosa* (see Table S2 for further details).

## Discussion

We found that spiders have evolved following the expectations of pendulum mechanics. First, spiders that move suspending their bodies have evolved disproportionately longer legs relative to wandering spiders. Second, in a species of suspensory spiders we show that longer legs allow faster suspensory movement and that these spiders are much faster as pendulums than as inverted pendulums. Third, across spider species, we show that as suspensory spiders increase in size they become less and less efficient at running on the ground, a pattern predicted by their disproportionately longer legs which confer relatively low joint forces.

We do not claim that bridging provides an energetic advantage over running on the ground. Bridging can be very costly for spiders because they have to invest in protein-expensive silk for building bridges and also preparing the bridge may be time and energy consuming, since the spider may have to try a few times to build a silk line until wind speed and turbulence are low enough to permit successful bridging. In addition, at least in primates, resting in the inverted position has actually been shown to be more expensive than resting standing on the four legs (Swartz 1989). However, the patterns observed are consistent with pendulums and inverted pendulums, and therefore in each context, spiders may be exploiting what it is more energetically efficient according to the mechanics of pendulums. It remains to be explored in detail how this mode of suspensory locomotion actually occurs, and how the eight legs and the BCM combine to take advantage of pendulum mechanics.

The findings reported here have potentially important ecological and evolutionary implications. The following are four hypotheses based on what we know about spiders and should be independently tested. First, the fact that performance on the ground diverges with body size according to living mode can explain why only the very small *Erigoninae* (*Linyphiidae*) show behavioral plasticity, hanging from their webs when prey are abundant, or leaving their webs and wander around in search for prey when food is scarce (Alderweireldt 1994). Second, our

findings could also partially explain why in the large hanging spider *Latrodectus revivensis* the youngest instars freely change web sizes, while the adult females tend to remain in the same sites until death (Lubin et al. 1993). This is especially important in desert habitats, where vegetation is scarce and bridging from one plant to the other may not be possible. Indeed, females of another species within the same genus (*L. lilianae*) have been observed to disperse by walking on the ground (JML personal observations). During ground dispersal, these spiders could be sufficiently large to be conspicuous to most predators while they would be too slow to escape their attacks. Third, it has been suggested that extreme sexual size dimorphism (SSD) in spiders has evolved only in species in which females are large and live in tall places, because smaller males have an advantage in climbing and reaching females (Moya-Laraño et al. 2002; Foellmer & Moya-Laraño 2007). However, in most, if not all, spider species with extreme SSD, males do not just climb, but bridge from one plant to another during mate search. If vegetation is scarce, males will have to also walk to reach females, and in that context it pays the males to be small (for example to be less conspicuous to aerial predators), since being too large will entail no advantage as the relationship between body size and faster movement on the ground is lost. Lastly, sociality has evolved a few times independently in spiders (Aviles 1997; Lubin & Bilde 2007) and in several cases sociality has evolved in spiders that hang upside-down. Since sociality in spiders has occurred gradually and the intermediate stages of social evolution entail an elongation of the period of communal life of the young stages, we hypothesize that during the early evolution of sociality, a possible advantage of elongating the communal period could be that selection on the young instars to disperse later would come from the survival benefit of faster bridging (dispersal) mediated by their disproportionately longer legs. However, we acknowledge that other variables are still at play and may be actually more relevant than simple faster dispersal (e.g., food availability and quality). Alternatively, these legs may allow dispersal to longer distances for a fixed amount of allocated energy, thus enhancing outbreeding. Longer dispersal distances of larger siblings have been documented in the subsocial spider *Anelosimus cf. jucundus* (Powers & Aviles 2003). Thus, pendulum mechanics could favour retention in the natal nest for longer periods that could lead to eventual phylopatry or, on the other hand, dispersal to longer distances, indirectly influencing the evolution of

sociality in spiders through influencing metapopulation dynamics. We hope that taking pendulum mechanics into consideration will serve to expand the breadth of research in this important group of generalist predators.

Importantly, our findings show that an animal that has to perform equally well hanging or standing cannot be larger than a certain threshold body size. These have implications for robotics, since for a robot shaped like an animal to be able to walk with the same efficiency both as a pendulum and as an inverted pendulum it would have to be fairly small. Another solution would be to build a larger robot with stronger (more powerful) legs. However, the later design would be more energetically costly and would therefore allow shorter autonomy to the robot. Alternatively, adding springs to the legs (analogous to tendons in humans (Dickinson et al. 2000; Alexander 2003) could allow robots to be larger with longer than usual legs and still move efficiently.

## **Materials and Methods**

### **Comparative data**

Morphological data on adult females of 105 spider species belonging to 25 spider families were obtained from Roberts' (Roberts 1985a; Roberts 1985b) plates (Table S1). We measured the following morphological traits: carapace width (CW), right foreleg tibia length (FTL) and foreleg tibia diameter (FTD). Forelegs should be the most important for pulling the body during bridging on a silk thread, and if the pendulum hypothesis is correct they should be the most modified according to living posture. We used the length of the tibia as a measurement of leg length because this is the easiest leg segment to measure in Roberts' drawings. Tibia diameters were measured in the center of the tibias. Spider traits were directly measured to the nearest 0.1 mm from the drawings in Roberts' (Roberts 1985a; Roberts 1985b) book by using a caliper. The measurements were re-scaled relative to the average length of each species following the information in Roberts (Roberts 1995). Information about living posture (i.e. standing or hanging) was obtained from different sources.

We used the information provided by Roberts himself (Roberts 1985a; Roberts 1985b; Roberts 1995), a field guide (Jones 1985) and direct field and laboratory observations (JM, EM and GC personal observations). In particular, the Dycytinidae were included as hanging spiders because when they are in a jar in the laboratory they build a web and hang underneath. When in doubt, we sought for additional information about the same spider genera in the Nearctic fauna (Kaston 1981).

The spider drawings (Roberts 1985a; Roberts 1985b) could lack accuracy for a number of reasons. Thus, in order to validate the Roberts' data set, data on 16 spider species (belonging to 10 different families –40% of families in the Roberts' data set–) were additionally obtained by directly measuring individuals from the National Museum of Natural Sciences of Spain (MNCN), all of which were collected either in Spain or in Germany. Spiders from the MNCN were measured to the nearest 0.01 mm under a dissection microscope. We found high repeatability between data sets for all measured traits: CW ( $R = 0.95$ ), FTL ( $R = 0.97$ ), FTD ( $R = 0.96$ ) and thus considered that the Roberts's data set was highly reliable for analysis.

### **Comparative analyses**

Species data points are not directly adequate for comparative analyses because they are not independent (Felsenstein 1985; Garland et al. 1992). Therefore, we tested the main predictions using a compiled spider phylogeny and the method of phylogenetically independent contrasts (ICs) to account for phylogenetic relationships (Felsenstein 1985). To obtain ICs we used the PDAP computer package (Garland et al. 1992). We adopted the family level areneomorph phylogenetic hypothesis (Coddington 2005) and updated with recent phylogenies (Hormiga 2000; Maddison & Hedin 2003; Arnedo et al. 2004; Miller & Hormiga 2004; Murphy et al. 2006) as in previous work (Moya-Laraño et al. 2002; Foellmer & Moya-Laraño 2007) (Fig. S1). In the absence of an accurate phylogeny, tips and higher nodes in our phylogenetic tree were included at their taxonomic level; i.e. politomies, (Garland et al. 1992). Branch lengths were assumed to be constant across the phylogeny. Because the independent variable (i.e. spider size) was measured with error, we applied Major Axis regression (Warton et al. 2006) for estimating the scaling of leg traits with body size. All variables were log-transformed

for analysis. For comparing if the slopes were significantly different for hanging than for standing spiders, and thus to test for a significant difference in the evolution of body shape consistent with pendulum mechanics, we ran a phylogenetically controlled ANCOVA using PDSIMUL followed by PDANOVA within the PDAP computer package (Garland et al. 1992). This procedure is necessary to take into account the independent evolutionary switches from predominantly hanging to predominantly standing positions and *vice versa*. In our data set we could identify five independent switches (Fig. S1).

### Velocity trials

All spiders used were collected either around Almería (southeast Spain) or around Huelva (southwest Spain). All spiders were kept in jars of variable size according to their own size and all were used within 48 hours after collection. Trials were run at room temperature (range 19.7-22.7°C). We recorded the races in a video-camera (Sony CCD-TRV608) for later calculating speed at 30 frames/s. After trials were finished, individuals were killed by freezing and preserved in 70% ETOH. Morphological traits were measured by GC and EM as described above (between-observer repeatability > 0.9 for all traits).

*Running on the ground.* To study the performance of spiders on flat surfaces, we induced spiders to run on a race track (50 cm length, 15cm width) which had a layer of fine sand as substrate. We released the spider from the jar and chased it until a straight running trajectory was recorded. Since the main objective was to use as much of a wide size range as possible, we used spiders of variable instars. Since spider mass ranged from 0.65 mg to 1,242 mg, the length of the race varied accordingly (i.e., 1.8-38 cm). A list of the spider taxa used, their living posture and sample sizes can be found in Table S1.

*Bridging trials – Suspensory locomotion.* We used 41 juvenile individuals of the hanging web-building spider *Anelosimus aulicus* (Theridiidae) of different instars (mass range 0.1-3 mg). Each spider was tested twice in a randomly assigned order: running on the ground (as above) and bridging. In order to induce bridging, we located a blowing fan (Solac Vento mod. 685) 3 meters away from the place where



the spider was released, which produced a low-turbulence air flow of 0.8 m/s. The spider was released on top of a 10x10 mm wireframe located on a 15 cm height pedestal. In order to allow the silk to attach downwind, we aligned a fragment of plant at a distance of 18 cm from the wire. Most of spiders attached a silk line to the plant within the first 5 minutes. Otherwise ( $n = 6$  instances), the spider was touched gently with the tip of a pencil, which made the spider hang from a drag line and triggered the release of a silk line. All variables were log-transformed for analysis. We estimated the ontogenetic allometry of leg length with body size as above and we then calculated OLS residuals of FTL against CW. If longer legs allow spiders to run faster upside-down, we expected to see a positive relationship between the FTL residuals and bridging speed and also that a regression model of FTL residuals predicting bridging speed would be more parsimonious (i.e., lower Akaike's Information Criterion, AIC) than a model predicting running speed on the ground.

## **Acknowledgments**

We thank L. Avilés, T. Bilde, W. Blanckenhorn, D. Fairbairn, M. Foellmer, F. Vollrath and D. Wise for comments. J.M. Avilés and M. Foellmer kindly introduced us to the PDAP package.

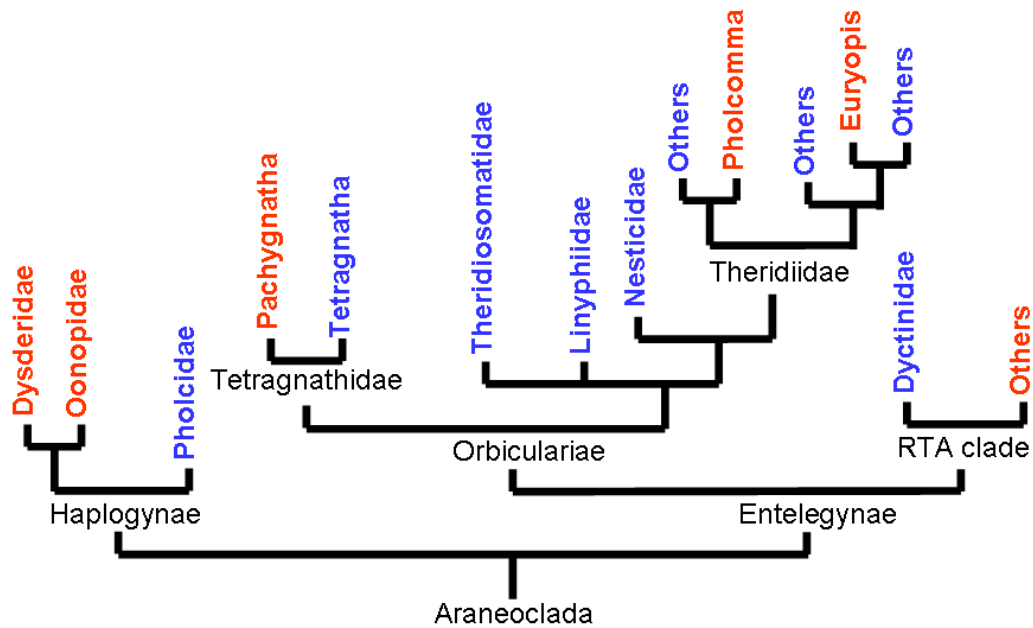
## References

- Alderweireldt, M. 1994. Prey selection and prey capture strategies of linyphiid spiders in high-input agricultural fields. *Bulletin of the British Arachnological Society (United Kingdom)* 9, 583-602.
- Alexander, R.M. 2003. *Principles of Animal Locomotion*. Princeton: Princeton University Press. 371 pp.
- Arnedo, M.A., Coddington, J., Agnarsson, I. & Gillespie, R.G. 2004. From a comb to a tree: phylogenetic relationships of the comb-footed spiders (Araneae, Theridiidae) inferred from nuclear and mitochondrial genes. *Molecular Phylogenetics and Evolution* 31, 225-245.
- Arnold, S.J. 1983. Morphology, Performance and Fitness. *American Zoologist* 23, 347-361.
- Aviles, L. 1997. Causes and consequences of cooperation and permanent-sociality in spiders. In: *The evolution of social behaviour in insects and arachnids*. J.C. Choe & In: *The Evolution of Social Behaviour in Insects and Arachnids* (Ed. by J. Choe & B. Crespi), pp. 476-498. Cambridge, Cambridge University Press.
- Bauwens, D., Garland, T., Castilla, A.M. & Vandamme, R. 1995. Evolution of Sprint Speed in Lacertid Lizards - Morphological, Physiological, and Behavioral Covariation. *Evolution* 49, 848-863.
- Bertram, J.E.A., Ruina, A., Cannon, C.E., Chang, Y.H. & Coleman, M.J. 1999. A point-mass model of gibbon locomotion. *Journal of Experimental Biology* 202, 2609-2617.
- Coddington, J.A. 2005. Phylogeny and classification of spiders. In: *Spiders of North America: an Identification Manual American* (Ed. by D. Ubick, P.E. Cushing, P.E. Paquin & V. Roth), pp. 18-24. American Arachnological Society.
- Dickinson, M.H., Farley, C.T., Full, R.J., Koehl, M.A.R., Kram, R. & Lehman, S. 2000. How animals move: An integrative view. *Science* 288, 100-106.
- Felsenstein, J. 1985. Phylogenies and the Comparative Method. *American Naturalist* 125, 1-15.
- Foelix, R.F. 1996. *Biology of Spiders*. 2<sup>nd</sup> edn. Oxford: Oxford University Press. 336 pp.
- Foellmer, M.W. & Moya-Laraño, J. 2007. Sexual Size Dimorphism in Spiders. In: *Sex, Size & Gender Roles. Evolutionary Studies of Sexual Size Dimorphism* (Ed. by D.J. Fairbairn, W.U. Blanckenhorn & T. Székely), pp. 71-81. New York, Oxford University Press.

- Framenau, V.W. 2005. Gender specific differences in activity and home range reflect morphological dimorphism in wolf spiders (Araneae, Lycosidae). *Journal of Arachnology* 33, 334-346.
- Garland, T.Jr., Harvey, P.H. & Ives, A.R. 1992. Procedures for the Analysis of Comparative Data Using Phylogenetically Independent Contrasts. *Systematic Biology* 41, 18-32.
- Gomes, M.W. & Ruina, A.L. 2005. A five-link 2D brachiating ape model with life-like zero-energy-cost motions. *Journal of Theoretical Biology* 237, 265-278.
- Hallgrímsson, B. & Swartz, S. 1995. Biomechanical Adaptation of Ulnar Cross-Sectional Morphology in Brachiating Primates. *Journal of Morphology* 224, 111-123.
- Hormiga, G. 2000. Higher level phylogenetics of erigonine spiders (Araneae, Linyphiidae, Erigoninae). *Smithsonian Contributions to Zoology*.
- Jones, D. 1985. *Guía De Campo De Los Arácnidos De España y De Europa*. Barcelona: Omega. 368 pp.
- Kaston, B.J. 1981. *Spiders of Connecticut*. Revised edition edn. Hartford: State geological and natural history survey of Connecticut. 1020 pp.
- Lubin, Y. & Bilde, T. 2007. The evolution of sociality in spiders. *Advances in the Study of Behavior, Vol 37* 37, 83-145.
- Lubin, Y., Ellner, S. & Kotzman, M. 1993. Web Relocation and Habitat Selection in A Desert Widow Spider. *Ecology* 74, 1915-1928.
- Maddison, W.P. & Hedin, M.C. 2003. Jumping spider phylogeny (Araneae: Salticidae). *Invertebrate Systematics* 17, 529-549.
- Miller, J.A. & Hormiga, G. 2004. The unbearable lightness of being monophyletic: Clade stability and the addition of data: A case study from erigonine spiders (Araneae : Linyphiidae, Erigoninae). *Cladistics-the International Journal of the Willi Hennig Society* 20, 89.
- Moreno, E. & Carrascal, L.M. 1993. Leg Morphology and Feeding Postures in 4 Parus-Species - An Experimental Ecomorphological Approach. *Ecology* 74, 2037-2044.
- Moya-Laraño, J., Halaj, J. & Wise, D.H. 2002. Climbing to reach females: Romeo should be small. *Evolution* 56, 420-425.
- Murphy, N.P., Framenau, V.W., Donnellan, S.C., Harvey, M.S., Park, Y.C. & Austin, A.D. 2006. Phylogenetic reconstruction of the wolf spiders (Araneae : Lycosidae) using sequences from the 12S rRNA, 28S rRNA, and NADH1 genes: Implications for classification, biogeography, and the evolution of web building behavior. *Molecular Phylogenetics and Evolution* 38, 583-602.

- Peters,H.M. 1990. On the structure and glandular origin of bridging lines used by spiders for moving to distant places. *Acta Zoologica Fennica* 190, 309-314.
- Powers,K.S. & Aviles,L. 2003. Natal dispersal patterns of a subsocial spider *Anelosimus cf. jucundus* (Theridiidae). *Ethology* 109, 725-737.
- Ramos,M.M., Irschick,D. & Christenson,T. 2004. Overcoming an evolutionary conflict: Removal of a reproductive organ greatly increases locomotor performance. *PNAS* 101 , 4883-4887.
- Roberts,M.J. 1985a. *The Spiders of Great Britain and Ireland. Vol. 1.* Colchester: Harley Books. 434 pp.
- Roberts,M.J. 1985b. *The Spiders of Great Britain and Ireland. Vol. 2.* Colchester: Harley Books. 256 pp.
- Roberts,M.J. 1995. *Spiders of Britain and Northern Europe.* London: Harpen Collins. 383 pp.
- Srinivasan,M. & Ruina,A. 2006. Computer optimization of a minimal biped model discovers walking and running. *Nature* 439, 72-75.
- Swartz,S.M. 1989. Pendular Mechanics and the Kinematics and Energetics of Brachiating Locomotion. *International Journal of Primatology* 10, 387-418.
- Warton,D.I., Wright,I.J., Falster,D.S. & Westoby,M. 2006. Bivariate line-fitting methods for allometry. *Biological Reviews* 81, 259-291.
- Wise,D.H. 1993. *Spiders in Ecological Webs.* New York: Cambridge University Press. 346 pp.

## Supporting Information



**Fig. S1. Simplified phylogenetic relationships of the spiders used in this study.** Others refer to species or clades that are part of the study but that have not switched living mode. Red, standing spiders; Blue, hanging spiders. Although not used in this study, some other spiders have gained back the ability to hang from their webs, such as the Psechridae within the RTA clade. The phylogenetic relationships for the entire phylogeny were obtained from refs. 19-24.

**Table S1. Species used for comparative analyses, along with their living modes**

Family	Genus	Species	Living mode
Agelenidae	<i>Agelena</i>	<i>labyrinthica</i>	STANDING
Agelenidae	<i>Tegenaria</i>	<i>domestica</i>	STANDING
Agelenidae	<i>Textrix</i>	<i>denticulata</i>	STANDING
Amaurobiidae	<i>Amaurobius</i>	<i>similis</i>	STANDING
Amaurobiidae	<i>Coelotes</i>	<i>atropos</i>	STANDING
Clubionidae	<i>Clubiona</i>	<i>diversa</i>	STANDING
Clubionidae	<i>Clubiona</i>	<i>compta</i>	STANDING
Clubionidae	<i>Clubiona</i>	<i>lutescens</i>	STANDING
Dictynidae	<i>Argenna</i>	<i>subnigra</i>	HANGING
Dictynidae	<i>Altella</i>	<i>lucida</i>	HANGING
Dictynidae	<i>Dictyna</i>	<i>arundinacea</i>	HANGING
Dictynidae	<i>Dictyna</i>	<i>uncinata</i>	HANGING
Dictynidae	<i>Lathys</i>	<i>humilis</i>	HANGING
Dysderidae	<i>Dysdera</i>	<i>erythrina</i>	STANDING
Dysderidae	<i>Harpactea</i>	<i>hombergi</i>	STANDING
Erigonidae	<i>Ceratinella</i>	<i>brevipes</i>	HANGING
Erigonidae	<i>Ceratinella</i>	<i>scabrosa</i>	HANGING
Erigonidae	<i>Dicymbium</i>	<i>nigrum</i>	HANGING
Erigonidae	<i>Entelecara</i>	<i>erythropus</i>	HANGING
Erigonidae	<i>Moebelia</i>	<i>penicillata</i>	HANGING
Erigonidae	<i>Walckenaeria</i>	<i>acuminata</i>	HANGING
Erigonidae	<i>Walckenaeria</i>	<i>atrotibialis</i>	HANGING
Erigonidae	<i>Walckenaeria</i>	<i>cuspidata</i>	HANGING
Gnaphosidae	<i>Drassodes</i>	<i>cupreus</i>	STANDING
Gnaphosidae	<i>Micaria</i>	<i>pulicaria</i>	STANDING
Gnaphosidae	<i>Phaeoecelus</i>	<i>braccatus</i>	STANDING
Gnaphosidae	<i>Scotophaeus</i>	<i>blackwalli</i>	STANDING
Gnaphosidae	<i>Zelotes</i>	<i>pedestris</i>	STANDING
Hahniidae	<i>Antistea</i>	<i>elegans</i>	STANDING
Hahniidae	<i>Hahnia</i>	<i>montana</i>	STANDING
Hahniidae	<i>Hahnia</i>	<i>nava</i>	STANDING
Hahniidae	<i>Hahnia</i>	<i>pusilla</i>	STANDING
Linyphiidae	<i>Helophora</i>	<i>insignis</i>	HANGING
Linyphiidae	<i>Lepthyphantes</i>	<i>minutus</i>	HANGING
Linyphiidae	<i>Linyphia</i>	<i>hortensis</i>	HANGING

Linyphiidae	<i>Linyphia</i>	<i>triangularis</i>	HANGING
Linyphiidae	<i>Microlinyphia</i>	<i>pusilla</i>	HANGING
Linyphiidae	<i>Neriene</i>	<i>peltata</i>	HANGING
Linyphiidae	<i>Pityohyphantes</i>	<i>phrygianus</i>	HANGING
Liocranidae	<i>Agroeca</i>	<i>proxima</i>	STANDING
Liocranidae	<i>Agroeca</i>	<i>striata</i>	STANDING
Liocranidae	<i>Scotina</i>	<i>celans</i>	STANDING
Lycosidae	<i>Arctosa</i>	<i>leopardus</i>	STANDING
Lycosidae	<i>Alopecosa</i>	<i>pulverulenta</i>	STANDING
Lycosidae	<i>Arctosa</i>	<i>perita</i>	STANDING
Lycosidae	<i>Aulonia</i>	<i>albimana</i>	STANDING
Lycosidae	<i>Hygrolycosa</i>	<i>rubrofasciata</i>	STANDING
Lycosidae	<i>Pirata</i>	<i>piraticus</i>	STANDING
Lycosidae	<i>Pirata</i>	<i>hygrophilus</i>	STANDING
Lycosidae	<i>Pardosa</i>	<i>amentata</i>	STANDING
Lycosidae	<i>Pardosa</i>	<i>pullata</i>	STANDING
Lycosidae	<i>Pirata</i>	<i>latitans</i>	STANDING
Lycosidae	<i>Trochosa</i>	<i>terricola</i>	STANDING
Lycosidae	<i>Xerolycosa</i>	<i>miniata</i>	STANDING
Miturgidae	<i>Cheiracanthium</i>	<i>erraticum</i>	STANDING
Nesticidae	<i>Nesticus</i>	<i>cellulanus</i>	HANGING
Oonopidae	<i>Oonops</i>	<i>pulcher</i>	STANDING
Oxyopidae	<i>Oxyopes</i>	<i>heterophthalmus</i>	STANDING
Philodromidae	<i>Philodromus</i>	<i>cespitem</i>	STANDING
Philodromidae	<i>Philodromus</i>	<i>fallax</i>	STANDING
Philodromidae	<i>Tanatus</i>	<i>striatus</i>	STANDING
Philodromidae	<i>Tibellus</i>	<i>oblongus</i>	STANDING
Pholcidae	<i>Pholcus</i>	<i>phalangioides</i>	HANGING
Pholcidae	<i>Psilochorus</i>	<i>simoni</i>	HANGING
Pisauridae	<i>Pisaura</i>	<i>mirabilis</i>	STANDING
Salticidae	<i>Ballus</i>	<i>depressus</i>	STANDING
Salticidae	<i>Euophrys</i>	<i>frontalis</i>	STANDING
Salticidae	<i>Heliophanus</i>	<i>flavipes</i>	STANDING
Salticidae	<i>Marpissa</i>	<i>muscosa</i>	STANDING
Salticidae	<i>Marpissa</i>	<i>nivoyi</i>	STANDING
Salticidae	<i>Myrmarachne</i>	<i>formicaria</i>	STANDING
Salticidae	<i>Neon</i>	<i>reticulatus</i>	STANDING
Salticidae	<i>Salticus</i>	<i>scenicus</i>	STANDING
Salticidae	<i>Sitticus</i>	<i>caricis</i>	STANDING
Salticidae	<i>Sitticus</i>	<i>pubescens</i>	STANDING
Sparassidae	<i>Micrommata</i>	<i>virescens</i>	STANDING
Tetragnathidae	<i>Pachygnatha</i>	<i>clercki</i>	STANDING

Tetragnathidae	<i>Pachygnatha</i>	<i>degeeri</i>	STANDING
Tetragnathidae	<i>Tetragnatha</i>	<i>extensa</i>	HANGING
Theridiidae	<i>Achaeearanea</i>	<i>lunata</i>	HANGING
Theridiidae	<i>Anelosimus</i>	<i>aulicus</i>	HANGING
Theridiidae	<i>Crustulina</i>	<i>guttata</i>	HANGING
Theridiidae	<i>Crustulina</i>	<i>sticta</i>	HANGING
Theridiidae	<i>Dipoena</i>	<i>inornata</i>	HANGING
Theridiidae	<i>Episinus</i>	<i>angulatus</i>	HANGING
Theridiidae	<i>Enoplognatha</i>	<i>ovata</i>	HANGING
Theridiidae	<i>Enoplognatha</i>	<i>thoracica</i>	HANGING
Theridiidae	<i>Euryopis</i>	<i>flavomaculata</i>	STANDING
Theridiidae	<i>Pholcomma</i>	<i>gibbum</i>	STANDING
Theridiidae	<i>Robertus</i>	<i>libidus</i>	HANGING
Theridiidae	<i>Steatoda</i>	<i>albomaculata</i>	HANGING
Theridiidae	<i>Steatoda</i>	<i>bipunctata</i>	HANGING
Theridiidae	<i>Theridion</i>	<i>bimaculatum</i>	HANGING
Theridiidae	<i>Theridion</i>	<i>blackwalli</i>	HANGING
Theridiidae	<i>Theridion</i>	<i>pallens</i>	HANGING
Theridiidae	<i>Theridion</i>	<i>tinctum</i>	HANGING
Theridiidae	<i>Theridion</i>	<i>sisyphium</i>	HANGING
Theridiosomatidae	<i>Theridiosoma</i>	<i>gemmosum</i>	HANGING
Thomisidae	<i>Diaea</i>	<i>dorsata</i>	STANDING
Thomisidae	<i>Misumena</i>	<i>vatia</i>	STANDING
Thomisidae	<i>Oxyptila</i>	<i>sanctuararia</i>	STANDING
Thomisidae	<i>Oxyptila</i>	<i>atomaria</i>	STANDING
Thomisidae	<i>Thomisus</i>	<i>onustus</i>	STANDING
Thomisidae	<i>Xysticus</i>	<i>cristatus</i>	STANDING
Zoridae	<i>Zora</i>	<i>spinimana</i>	STANDING



**Table S2. Spider taxa, living modes and sample sizes used in the ground races (Fig. 4).**

Family	Genus (1)	Species (2)	Living mode	Sample size
Theridiidae	<i>Anelosimus</i>		HANGING	28
Pholcidae	<i>Holocnemus</i>		HANGING	4
Theridiidae	<i>Latrodectus</i>		HANGING	4
Dictynidae	<i>Dyctina</i>		HANGING	4
Phocidae	<i>Pholcus</i>		HANGING	16
Theridiidae	<i>Steatoda</i>	<i>paykulliana</i>	HANGING	7
		<i>triangulosa</i>	HANGING	19
Gnaphosidae	<i>Haplodrassus</i>		STANDING	6
Lycosidae	<i>Hogna</i>		STANDING	11
Sparassidae (3)	<i>Olios</i>		STANDING	1
		<i>Micrommata</i>	STANDING	1
Lycosidae	<i>Pardosa</i>		STANDING	7
Philodromidae	<i>Philodromus</i>		STANDING	8

(1) Since young instars are very difficult to identify to the species level, more than one species may be included in this sample

(2) Two species of *Steatoda* were easily distinguished even when they were young. Due to their large differences in body size, we included them separately

(3) Only two individuals belonging to two different genera within the Sparassidae were included. Since body size and body shape were similar, we pooled them in a single category of Sparassidae for analysis



# MANUSCRIPT II

## Silk elasticity as a potential constraint on spider body size

Miguel A. Rodríguez-Gironés<sup>1</sup>, Guadalupe Corcobado<sup>1</sup>, Jordi Moya-Laraño<sup>1,2</sup>

<sup>1</sup>Dpto. de Ecología Funcional y Evolutiva, Estación Experimental de Zonas Áridas, CSIC, Carretera de Sacramento, s/n. La Cañada de San Urbano, C.P. 04120. Almería, Spain.

<sup>2</sup> Cantabric Institute of Biodiversity (ICAB). Dpto. de Organismos y Sistemas. Universidad de Oviedo, Catedrático Rodrigo Uría, s/n, 33006-Oviedo, Spain.



*Journal of Theoretical Biology* 266 (2010) 430–435

## Resumen

La seda es conocida por su resistencia y extensibilidad y ha desempeñado un papel clave en la radiación de las arañas. Las arañas usan diferentes glándulas para producir distintos tipos de seda formados por combinaciones únicas de proteínas. La mayoría de los investigadores han estudiado dos tipos de seda conocidos como “*major ampullate silk*” y “*capture spirals silk*” (seda espiral de captura) así como sus implicaciones ecológicas, mientras se conoce muy poco sobre otro tipo de seda conocida como “*minor ampullate silk*”, que se usa para desplazarse mediante puenteo, en las especies estudiadas hasta la fecha. Un modelo biomecánico parametrizado con los datos disponibles muestra que el radio mínimo de los filamentos de seda que se requiere para puentear eficientemente crece con la raíz cuadrada del peso de la araña, más rápido que el radio de los filamentos de seda del tipo “*minor ampullate*” producidos realmente por las arañas. Dado que la morfología de las arañas especializadas en moverse a través de hilos de seda está mal adaptada a caminar sobre superficies sólidas, en estas especies existe una relación negativa entre peso corporal y habilidad para desplazarse. Los resultados del modelo sugieren que las especies de arañas que usan seda para sus desplazamientos no podrían alcanzar un tamaño corporal muy grande si necesitan explorar el espacio para conseguir recursos. Particularmente, la elasticidad de la seda favorecería la existencia de dimorfismo sexual en el tamaño dado que los machos que usen hilos de puenteo para buscar pareja no podrían alcanzar un gran tamaño.

**Palabras clave:** *biomecánica, dispersión, seda del tipo “minor ampullate”, radiación, dimorfismo sexual en el tamaño (SSD del inglés “sexual size dimorphism”)*

## Abstract

Silk is known for its strength and extensibility and has played a key role in the radiation of spiders. Individual spiders use different glands to produce silk types with unique sets of proteins. Most research has studied the properties of major ampullate and capture spiral silks and their ecological implications, while little is known about minor ampullate silk, the type used by those spider species studied to date for bridging displacements. A biomechanical model parameterised with available data shows that the minimum radius of silk filaments required for efficient bridging grows with the square root of the spider's body mass, faster than the radius of minor ampullate silk filaments actually produced by spiders. Because the morphology of spiders adapted to walking along or under silk threads is ill suited for moving on a solid surface, for these species there is a negative relationship between body mass and displacement ability. As it stands, the model suggests that spiders that use silk for their displacements are prevented from attaining a large body size if they must track their resources in space. In particular, silk elasticity would favour sexual size dimorphism because males that must use bridging lines to search for females cannot grow large.

**Key words:** *biomechanics, dispersal, minor ampullate silk, radiation, sexual size dimorphism (SSD)*

## Introduction

Silk has played a key role in the radiation of spiders (Vollrath & Selden 2007; Blackledge et al. 2009) following the colonisation of land by their ancestors in the early Devonian (Selden, Shear & Bonamo 1991; Shear et al. 1989). The number of silk-producing glands and silk types that individual spiders produce has increased during the evolution of the group, and orb-weaving spiders spin seven different kinds of silk, including five fibrous silks that contain unique sets of proteins (Foelix 1996). Regardless of the selective pressures leading to the initial production of silk by spiders, silk was quickly used to produce hunting devices, ranging from isolated threads to sophisticated webs (Vollrath & Selden 2007) that have fostered the coevolutionary arms race between insects and spiders (e.g. Blackledge, Coddington & Gillespie 2003) –to the point that it has been suggested that the exponential diversification of insects may have resulted from selection favouring insects escaping from spider predation (Penney 2004). It is possibly for this reason that most research on spider silk, be it on the mechanical properties of silk or their ecological implications, has focused on the major ampullate and spiral silks used in web building (Kohler & Vollrath 1995; Denny 1976; Gosline et al. 1999; Kitagawa & Kitayama 1997) and very little is known about other silk types, such as the minor ampullate silk that those spider species that have been studied use for bridging displacements (Peters 1990). In this paper we study the constraints that the physical properties of minor ampullate silk could set on the displacement ability of spiders.

The morphological traits allowing efficient locomotion in spiders that spend most of their life hanging upside-down from their webs are very different from those favoured in spiders that must support their weights on their legs while walking on solid surfaces (Moya-Laraño et al. 2008 *manuscript I of this thesis*). As a result, spiders adapted to moving along silk fibres are clumsy when moving on hard surfaces. But these spiders have turned their weakness into strength, developing an efficient displacement mechanism: bridging. To use this displacement method, a

spider releases a bridging line until it adheres to some substrate, spanning a gap in the vegetation. The spider then tightens the line (Moya-Laraño et al., 2008 *manuscript I of this thesis*; Peters 1990) and crawls across the silk threads. Although bridging has received relatively little attention in the literature, in the only species that have been studied in detail (*Linyphia triangularis* and *Araneus diadematus*) the bridging line is composed of two minor ampullate silk filaments (Peters 1990). Bridging frees spiders at once from the need to support their own weight (Moya-Laraño et al. 2008 *manuscript I of this thesis*) and the constraint to follow the complex, fractal-like three-dimensional structure of vegetation for their displacements. Bridging is widespread in the Orbicularia clade. It is such an efficient displacement mechanism that it has been secondarily adopted by vegetation-dwelling sit-and-wait predatory groups like the Thomisidae – a family belonging to the Dyonicha group which lost the web-building ability when it diverged within the RTA clade (Coddington & Levi 1991).

Although bridging is made possible by the remarkable mechanical properties of silk, even the finest materials have their limits. Large spiders are seldom seen bridging in the field, and Morse and Fritz (1982) have suggested that the elasticity of silk fibres prevents large crab spiders from bridging. Bridging lines sag under the weight of crossing spiders, and bridging will only be successful if the sag is less than the clearance under the line – otherwise the bridging spider will be dragged into the soil or vegetation. To evaluate the possibility that the elasticity of minor ampullate silk makes bridging inefficient for large spiders, we develop a biomechanical model to calculate the relationship between the cross section of the fibre, its elastic properties, the mass of the spider,  $m$ , and the sag of the line,  $k$  (hereafter defined as the maximal vertical displacement of the bridging spider divided by the horizontal distance between the attachment points of the line), as the spider crosses it. For a given body mass, the relative sag of the line,  $k$ , depends on the stress, extensibility and cross section of the silk fibre. Because increasing the stress on the fibre eventually leads to its breaking, heavier spiders must release thicker silk filaments to prevent excessive sagging. Although in general the thickness of the silk fibre released by a spider depends on the number and type of silk glands engaged in the production of silk (Foelix 1996), bridging lines are composed of two filaments, produced by the left and right minor ampullate glands (Peters 1990), limiting the

control that spiders have over the thickness of their bridging lines essentially to the ability of increasing the diameter of these two fibre silks. Thus, the radius of the minor ampullate silk filaments produced by a spider may determine its bridging ability.

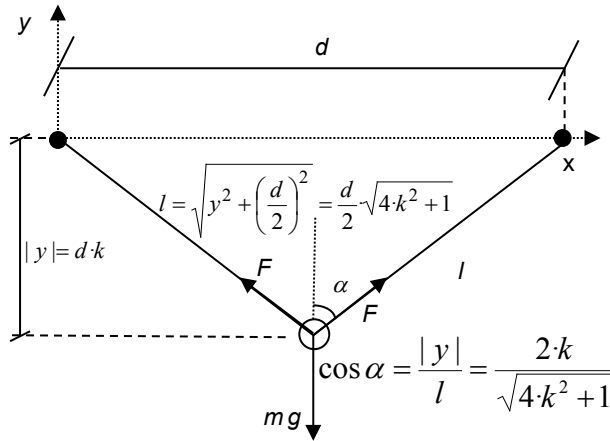
## The model

A spider of mass  $m$  bridges along a fibre composed of two silk filaments, each of them with radius  $r_0$  and length  $L_0$  when the fibre suffers no stress. The force exerted on the spider by the gravitational pull of the earth is directed downwards and has magnitude  $m \cdot g$ , where  $g = 9.8 \text{ m}\cdot\text{s}^{-2}$  is the acceleration of gravity. We will neglect the gravitational pull acting directly on the silk fibre itself – the mass of the bridging fibre is a tiny fraction of the mass of the spider. Let  $\varphi_{\max}$  be the true breaking strain ( $\log[\text{stretched length}/\text{rest length of fibre}]$  at the breaking point, (Roesler, Harders & Backer 2007)) of the minor ampullate silk fibre used for bridging and  $\tau_{\max}$  its true breaking stress (force/ instantaneous cross section at the breaking point, (Roesler et al. 2007)). The breaking strain is an index of the extensibility of the fibre: larger values of the breaking strain indicate that fibres suffer greater elongation before breaking. The breaking stress, on the other hand, denotes how much force (per unit area) we must apply before the fibre breaks. The safety coefficient, under which the fibre operates,  $\beta$ , is defined as the true breaking stress of the fibre divided by the maximum stress to which the fibre is actually exposed (Osaki 1996, 2003). Large safety coefficients indicate that the maximum stress (force per unit area) applied on the fibre is much lower than the stress required to break the fibre. The safety coefficient cannot be less than one: by definition, fibres break when the stress applied equals the breaking stress. Values only slightly larger than one indicate that the maximum stress applied on the fibre is close to the breaking stress.

To calculate the relationship between the radius at rest of the individual silk filaments,  $r_0$ , the relative sag,  $k$ , and safety coefficient,  $\beta$ , we note that both the maximal vertical displacement of the spider and maximal stress on the fibre are



achieved when the spider is at the midpoint of the fibre. By definition of relative sag, when the spider is midway through crossing its vertical displacement  $y$  satisfies the equation  $|y| = k \cdot d$ , and hence  $\cos \alpha = 2 \cdot k / \sqrt{4 \cdot k^2 + 1}$ , where  $d$  is the distance between the endpoints of the bridging line (greater than  $L_0$  if the spider has tightened the line) and  $\alpha$  is the angle between the vertical axis and the segment connecting the spider with an endpoint (Fig. 1). The vertical component of the forces exerted by the silk fibre on the spider (forces  $F$  in figure 1) must balance the gravitational pull.



**Figure 1. Force diagram.** Schematic representation of the forces acting on the spider when it is midway between the starting and finishing points of the bridging line, when the vertical displacement ( $|y|$ ) and forces along the silk lines ( $F$ ) attain their maximum value. If  $d$  represents the distance between the starting and finishing points of the bridging line, the relative sag is  $k = |y|/d$ .

Therefore:

$$m \cdot g = 2 \cdot F \cdot \cos \alpha = \frac{4 \cdot F \cdot k}{\sqrt{4 \cdot k^2 + 1}} = \frac{8 \cdot \pi \cdot r^2 \cdot T \cdot k}{\sqrt{4 \cdot k^2 + 1}}, \quad (1)$$

where  $r$  is the instantaneous radius of the silk filaments and  $T$  the true stress to which they are subject. Note that, in going from forces to stress we have multiplied the numerator by the cross section of the two minor ampullate silk filaments that constitute the bridging fibre (i.e.,  $F = 2 \cdot \pi \cdot r^2 \cdot T$ ). From the definition of the safety coefficient,  $\beta \cdot T = \tau_{\max}$ . Substituting in equation 1 and rearranging,

$$r = \sqrt{\frac{m \cdot g \cdot \beta \cdot \sqrt{4 \cdot k^2 + 1}}{8 \cdot \pi \cdot k \cdot \tau_{\max}}}. \quad (2)$$

Assuming constant volume during extension (Vollrath, Madsen & Shao 2001),

$$r_0 = \sqrt{\frac{m \cdot g \cdot \beta \cdot \sqrt{4 \cdot k^2 + 1}}{8 \cdot \pi \cdot k \cdot \tau_{\max}} \cdot \frac{L}{L_0}}. \quad (3)$$

The stress-strain diagram gives us the relationship between elongation and stress, and hence between  $L$  and  $\beta$ . For simplicity, we will assume a linear relationship between true stress and true strain, so that  $\log(L/L_0) = \varphi_{\max} \cdot T/\tau_{\max}$ . [Note that, due to the strain hardening of minor ampullate silk –i.e., its stress-strain curve is j-shaped (Blackledge & Hayashi 2006)–, this assumption underestimates the value of  $r_0$ : spiders will have to produce bridging lines slightly thicker than the model predicts although the approximation is fairly good when  $\beta \leq 2$ .] With this final assumption, and noting that because  $L$  in equation 3 represents the maximum length of the fibre, so that  $T/\tau_{\max} = 1/\beta$ , we have

$$r_0 = \sqrt{m \cdot g \cdot \beta \cdot \frac{\sqrt{4 \cdot k^2 + 1}}{8 \cdot \pi \cdot k \cdot \tau_{\max}} \cdot \exp\left(\frac{1}{\beta} \cdot \varphi_{\max}\right)}. \quad (4)$$

Comparison of the value of  $r_0$  computed from equation 4 with the radius of the minor ampullate silk filaments produced by a spider of mass  $m$  tells us whether the spider can bridge with the specified values of the safety coefficient and relative sag. We have only been able to obtain the radii of minor ampullate silk filaments produced by adult *Argiope trifasciata* (Hayashi, Blackledge & Lewis 2004) and *A. argentata* (Blackledge & Hayashi 2006) females of unreported body mass. We know, however, that the average radius (in metres) of single major ampullate silk filaments produced by *Araneus diadematus*, ranging from 0.00036 g first-instar hatchlings to gravid 1.15 g females, increases with the mass of the spider,  $m$  (in Kg) according to  $r \approx \sqrt{2.93 \cdot 10^{-9} \cdot m^{0.739} / \pi}$  (Ortlepp & Gosline 2008). Assuming that this relationship is similar in magnitude within and among species, we can write the radius of minor ampullate silk filaments,  $r_{\min}$ , as

$$r_{\min} = \xi \cdot \sqrt{\frac{2.93 \cdot 10^{-9} \cdot m^{0.739}}{\pi}}, \quad (5)$$

where  $\xi$  is the ratio between the radii of minor and major ampullate silk filaments. Equating  $r_{\min}$  from equation 5 and  $r_0$  from equation 4 we obtain the bridging threshold, or the maximum body size for which bridging is possible for a specified set of parameter values,  $m_{\max}$ :

$$m_{\max} = \left[ \frac{2.34 \cdot 10^{-8} \cdot k \cdot \xi^2 \cdot \tau_{\max}}{g \cdot \beta \cdot \sqrt{4 \cdot k^2 + 1}} \cdot \exp\left(-\frac{\varphi_{\max}}{\beta}\right) \right]^{1/0.261}. \quad (6)$$

### Choice of parameter values

Although the mechanical properties of minor ampullate silk fibres have been little studied, the breaking stress  $\tau_{\max}$  and breaking strain  $\phi_{\max}$  of minor ampullate silk have been measured for a few species. For *Argiope trifasciata*,  $\tau_{\max} = 752$  MPa and  $\phi_{\max} = 0.442$  (Hayashi et al. 2004), and for *A. argentata*  $\tau_{\max} = 923$  MPa and  $\phi_{\max} = 0.330$  (Blackledge & Hayashi 2006). These are the values we use for our calculations.

The average diameter of single major ampullate silk filaments was 3.24 and 3.5  $\mu\text{m}$  for *A. trifasciata* and *A. argentata*, respectively, while the average diameter of single minor ampullate silk filaments was 0.69 and 1.1  $\mu\text{m}$  for the same species (Blackledge & Hayashi 2006; Hayashi et al. 2004). According to the relationship found by Ortlepp and Gosline (Ortlepp & Gosline 2008) for *Araneus diadematus*, the major ampullate silk diameters would correspond to spiders of 350 and 450 mg, very reasonable for *A. trifasciata* and *A. argentata* adult females. In these two species, the ratio of minor over major ampullate silk filament diameter is  $\xi = 0.69/3.24 = 0.21$  and  $\xi = 1.1/3.5 = 0.31$ . Inspection of scanning electron microscope photographs of bridging fibres produced by *A. diadematus* and *Linyphia triangularis* (Peters 1990), however, suggests values closer to  $\xi = 0.5$ . It seems likely that the value of  $\xi$  changes with the size of spiders, and it is possible that the value of  $\xi$  differs between spiders producing silk fibres for bridging (Peters 1990) and spiders from which silk is actively extracted by experimenters (Blackledge & Hayashi 2006; Hayashi et al. 2004). To obtain a conservative estimate of the constraints that silk imposes on bridging spiders, we calculate the maximum body size for which bridging is possible (equation 6) for  $\xi = 0.5$  and 0.667.

Osaki (1996, 2003) reports that the safety coefficient for dragline silk used as lifeline (silk used for hanging while dropping from relatively high places) is  $\beta \geq 2$ . Our calculations are based on  $\beta \leq 2$ . Note that by choosing relatively small values of  $\beta$  and relatively large values of  $\xi$ , as compared with those measured in the lab, we ensure that we have conservative results: if silk elasticity limits spider's bridging, the real constraints will most likely be stronger than those we find.

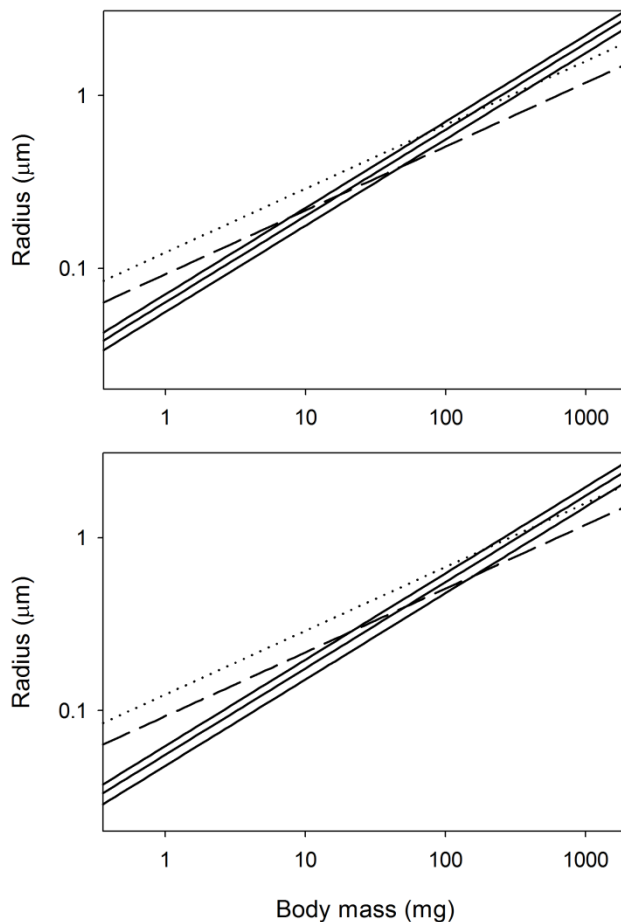
## Results

Figure 2 shows the square-root relationship between the mass of a spider,  $m$ , and the minimum radius of single minor ampullate silk filaments,  $r_0$ , that bridging *A. trifasciata* and *A. argentata* individuals require (eq. 4) for different values of the safety coefficient,  $\beta = 1.0, 1.5$  and  $2.0$ , if the relative sag cannot exceed the value  $k = 0.3$ . In a log-log plot, the safety coefficient and elastic properties of silk affect the intercept, but not the slope, of  $r_0$ . The intercept of  $r_0$  increases with the safety coefficient and the breaking strain of the silk, and decreases with its breaking stress. For comparison, the dotted and dashed lines in figure 2 represent the expected radii of single minor ampullate silk filaments,  $r_{\min}$  (equation 5), calculated with  $\xi = 0.5$  (dashed lines) or  $\xi = 0.67$  (dotted lines). Because  $r_0$  increases with  $m$  faster than  $r_{\min}$ , beyond a certain body mass the silk filaments produced by spiders are thinner than the filaments they would need for bridging with the desired parameters ( $r_{\min} < r_0$ ) and therefore bridging is not possible without increasing the relative sag or decreasing the safety coefficient. The body mass beyond which bridging is not feasible with the desired specifications is the bridging threshold,  $m_{\max}$  (equation 6).

The bridging threshold,  $m_{\max}$ , depends on the safety coefficient,  $\beta$ , the maximum relative sag allowed,  $k$ , and the physical properties of minor ampullate silk,  $\tau_{\max}$  and  $\varphi_{\max}$ . Figure 3 plots the bridging threshold of *A. argentata* and *A. trifasciata* as a function of the relative sag,  $k$ , for  $\beta = 1.5$  and  $2$ . Note (equation 6) that the coefficient  $\xi$  used to estimate the radii of the minor ampullate silk filaments produced by spiders (equation 5) has a multiplicative effect on the bridging threshold and therefore acts as a scale parameter.

Due to the uncertainty in the estimate of  $\tau_{\max}$ ,  $\varphi_{\max}$  and  $\xi$ , we have used equation 6 to calculate the relationship between the bridging threshold,  $m_{\max}$ , and these parameters when the safety coefficient is  $\beta = 2$  and the maximum relative sag allowed is  $k = 0.3$  (Fig. 4). If spiders produce minor ampullate silk filaments substantially thinner than major ampullate silk filaments ( $\xi \leq 0.6$ ), bridging should be inefficient for spiders over 200 mg for reasonable values of  $\tau_{\max}$  and  $\varphi_{\max}$ . When  $\xi$

= 0.7, the bridging threshold should lie around 250 mg if the values of  $\tau_{\max}$  and  $\varphi_{\max}$  measured for *A. trifasciata* and *A. argentata* are representative of the elastic properties of minor ampullate silk in other species, but the bridging threshold could increase substantially in species with stiffer (lower  $\varphi_{\max}$ ) or stronger (higher  $\tau_{\max}$ ) minor ampullate silk. Finally, if minor ampullate silk filaments are about as thick as major ampullate silk filaments ( $\xi \geq 0.8$ ), it seems unlikely that bridging is inefficient even for the larger spiders.

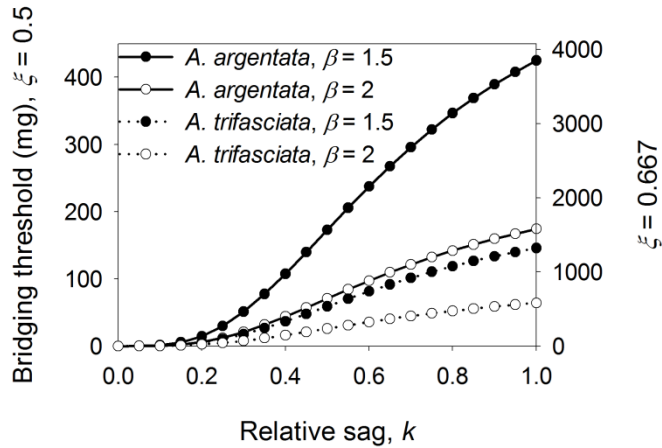


**Figure 2.** Minimal filament radius required for bridging. The solid lines represent the relationship between the mass of a spider,  $m$ , and the minimum radius of single minor ampullate silk filaments that spiders need for bridging,  $r_0$  (equation 4), when the relative sag cannot exceed the value  $k = 0.3$ . The values of  $r_0$  have been calculated using the mechanical properties of *A. trifasciata* (top panel) and *A. argentata* (bottom panel) minor ampullate silk. Each line represents a different safety coefficient (from top to bottom,  $\beta = 1.0, 1.5$  and  $2.0$ ). The dotted and dashed lines represent the expected radii of single minor ampullate silk filaments,  $r_{min}$  (equation 5), calculated with  $\xi = 0.5$  (dashed lines) or  $\xi = 0.67$  (dotted lines.)

## Discussion

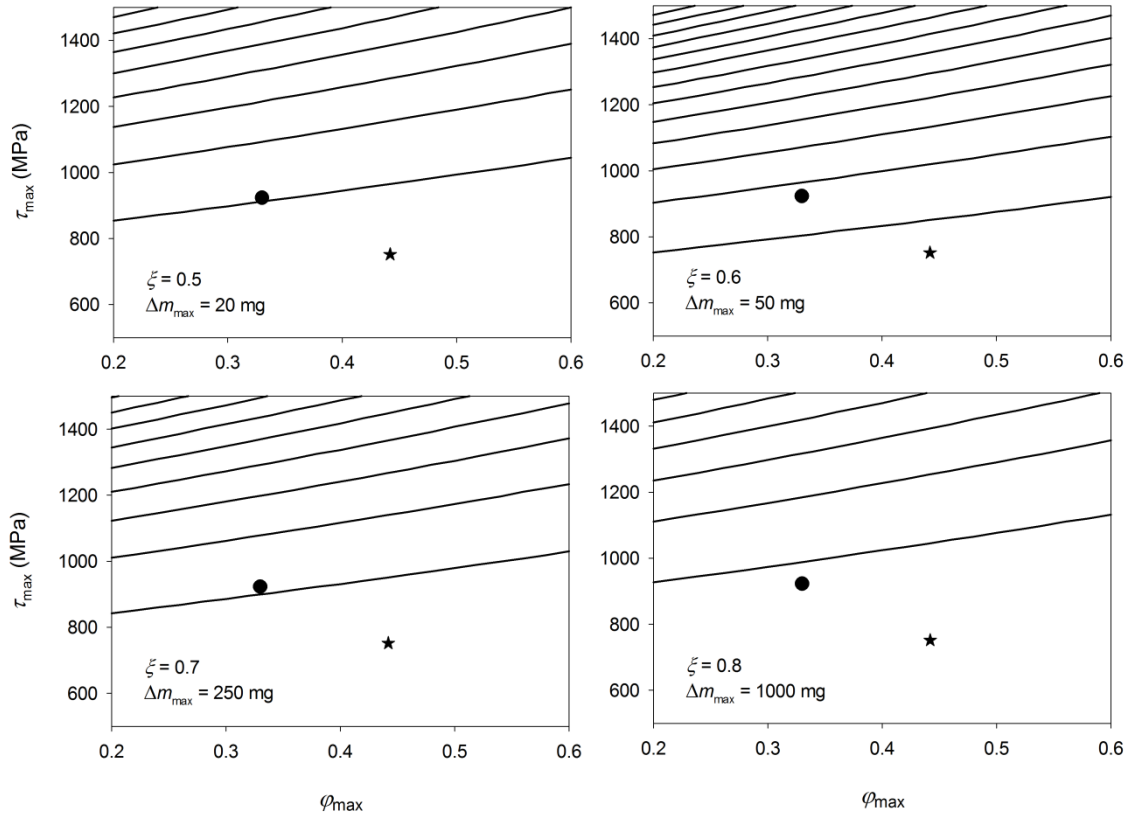
Simple mechanical considerations allow us to calculate the minimal radius of the silk filaments that the spider must use for bridging once we know the mechanical properties of silk, the relative sag that the line can accept without hitting the ground and the safety coefficient under which the line can operate. This radius increases with the square root of the spider's body mass and eventually becomes

greater than the radius of the minor ampullate silk filament that spiders produce. When the model is parameterised with available data, it predicts that the elasticity of minor ampullate silk severely limits the bridging abilities of heavy spiders.



**Figure 3.** Bridging threshold for *A. argentata* and *A. trifasciata*. Relationship between bridging threshold,  $m_{\max}$ , and relative sag,  $k$ , when the silk fibre has the mechanical properties characteristic of *A. argentata* (solid lines) and *A. trifasciata* (dotted lines) minor ampullate silk and the safety coefficient is  $\beta = 1.5$  (solid circles) or  $\beta = 2$  (empty circles). Because  $\xi$  has a multiplicative effect, it changes the scale, but not the shape, of the relationship. As a consequence, the same graph can be used to plot the bridging threshold when the ratio between major and minor ampullate silk filament radii is  $\xi = 0.5$  (left scale) or  $\xi = 0.667$  (right scale).

There is considerable across-species variability in the mechanical properties of major ampullate silk (Swanson et al. 2006) and it could be argued that heavy spiders are selected to produce minor ampullate silk stronger and stiffer than smaller spiders. Indeed, the minor ampullate silk of *A. argentata* is stronger and stiffer than the silk of *A. trifasciata* (Blackledge & Hayashi 2006; Hayashi et al. 2004). Nevertheless, the model has been parameterised with data from relatively large spiders, *A. argentata* and *A. trifasciata*, and predicts that neither of these species is an efficient bridger: an *A. argentata* of 400 mg producing minor ampullate silk filaments with a radius of  $0.82 \mu\text{m}$  (to be compared with the  $0.55 \mu\text{m}$  measured by Blackledge and Hayashi (2006)) and operating under a safety coefficient of  $\beta = 1.5$  would suffer a vertical displacement as large as the horizontal distance it tries to span through bridging ( $k = 1$ , figure 3) –the relative sag would be much larger for an adult *A. trifasciata* female– which would mean an overall travel distance 40% longer than in a normal bridging event. Therefore, even if heavier spiders produce stronger and stiffer minor ampullate silk than small spiders, they do not manage to compensate the effect of increasing body mass.



**Figure 4.** Contour plots of the bridging threshold. Panels represent, for different values of  $\xi$ , the relationship between the bridging threshold,  $m_{max}$ , and the elastic properties of minor ampullate silk,  $\tau_{max}$  and  $\phi_{max}$ , in a wide region that probably includes the true values for most species. The properties of minor ampullate silk in *A. trifasciata* (star) and *A. argentata* (circle) are indicated for comparison. Within each panel, the bottom line represents the set of points where the bridging threshold is  $m_{max} = \Delta m_{max}$ . As we move upwards within each panel, lines represent the set of points where the bridging threshold is  $m_{max} = 2 \cdot \Delta m_{max}$ ,  $m_{max} = 3 \cdot \Delta m_{max}$ , and so on. The values of  $\xi$  and  $\Delta m_{max}$  are given in the lower-left corner of each panel. Bridging thresholds have been calculated from equation 6, with  $\beta = 2$  and  $k = 0.3$ .

The relationship between spider size and the thickness of the minor ampullate filaments it produces, controlled by the parameter  $\xi$  of equation 5, plays an important role in determining bridging thresholds (equation 6, Figs. 2 and 4). If increasing  $\xi$  from 0.5 to 0.667 leads to a nine-fold increase in bridging threshold, reducing  $\xi$  from 0.5 to 0.4 (respectively 0.31) leads to a five-fold (respectively 39-fold) decrease in bridging threshold. The bridging thresholds we have calculated assume that minor ampullate silk filaments are at least half as thick as major ampullate silk filaments ( $\xi = 0.5$  and 0.667), which is much thicker than the values actually measured (Blackledge & Hayashi 2006; Hayashi et al. 2004). We have chosen such conservative estimates because filament diameter has been measured forcibly silking spiders (Blackledge & Hayashi 2006; Hayashi et al. 2004), and it is

therefore possible that the diameter of silk fibres produced in natural conditions is actually thicker.

Heavy spiders are less efficient bridgers than light ones. However, this does not mean that heavy spiders cannot bridge. Gravid giant orb-weaving females such as some species in the genera *Argiope*, *Araneus*, *Nephila* or *Caerostris*, for example, must use bridging during the initial stages of web building (Levi 1971; Burnet 1994). But they will only be able to do so when the clearance under their lines is large compared to the horizontal distance they must span (Fig. 3). Thus, according to the model, parameterised with conservative versions of available data, although spiders living in the canopy will be able to use bridging as a displacement mechanism, spiders moving through shrubs and annual plants, where horizontal distances can often be longer than the height of lines, will be unable to use bridging if their body mass exceeds 100 or 200 mg. The predictions of the model are supported by laboratory trials where 204 individual spiders of 13 species, in the families Araneidae, Tetragnathidae, Linyphiidae, Theridiidae and Thomisidae, were stimulated to bridge in order to escape from simulated high predation risk. There was a strong negative correlation between body mass and bridging propensity. No spider over 200 mg (N = 46) used bridging to emigrate from simulated risky patches, only one individual between 100 and 200 mg (N = 7) used bridging, while 81% of the individuals under 100 mg (N = 151) bridged away from risky patches – large individuals mainly dropped to the ground to leave the risky patch (Corcobado et al. 2010 *manuscript III of this thesis*).

In low vegetation, therefore, species adapted to moving along silk lines may have little mobility once they cross the 100 mg body mass limit and may only be able to grow as large as they can continue growing without further displacements. Crab spiders over 200 mg, for instance, cannot move to patches some 10 m away once their patch has wilted (Morse 2007). Since predator-prey body size ratios largely determine “who eats whom” in food webs (Brose et al. 2006; Woodward et al. 2005), this displacement constraint prevents crab spiders from reaching sizes sufficient to exploit resources that would, otherwise, be available to them, such as large carpenter bees and moths. Notice, however, that this constraint only applies to lifestyles that must track their resources in space. Strategies consisting in finding as



a juvenile a productive site where the individual remains through its life will be unaffected, and can continue growing as long as prey are abundant at their site.

The constraints imposed by minor ampullate silk elasticity on the displacement of large spiders are not limited to individuals looking for food: they apply to spiders searching for any other resources, such as mates. With few exceptions (Aisenberg, Viera & Costa 2007), males are the searching sex in spiders. After their last moult, males abandon their web or nest and disperse looking for receptive females (Foelix 1996). When females are too large for efficient bridging, males must be smaller than females or forego the possibility of using bridging for mate searching. Because, in many habitats, bridging could be a more efficient displacement mechanism than walking, the mechanical properties of silk may contribute to the evolution of sexual size dimorphism in spiders (Corcobado et al. 2010 *manuscript III of this thesis*).

Bridging plays an important role in the life of spiders adapted to moving along silk fibres (i.e. crab spiders within the RTA clade and Orbiculariae spiders). Because their morphology is unsuitable for walking along solid surfaces (Moya-Laraño et al. 2008 *manuscript I of this thesis*), they are seldom seen walking on the ground and depend on bridging for their mid-range displacements. As we have seen, the elastic properties of minor ampullate silk may make bridging an inefficient displacement mechanism for large spiders. The extent to which large body size constraints bridging ability, however, will depend on the precise values of the silk elasticity parameters and on the diameter of the filaments produced by spiders of different sizes. While we have used published data to parameterise the model, and have chosen rather conservative parameter values rather than the published ones, the scarcity of data prevents us from reaching final conclusions. Nevertheless, we hope that the results of our model prompt groups studying the mechanical properties of silk to devote more effort to the analysis of minor ampullate silk. It is also important to confirm that all (or at least most) spider species rely on minor ampullate silk for their bridging lines, as this result has been obtained from only two species (Peters 1990). It is important to understand how the physical properties of minor ampullate silk, including the thickness of the filaments produced, change with the size and ecology of species –and the extent to which aciniform silk filaments

attached to minor silk filaments, presumably to increase its drag (Peters 1990), affect the mechanical properties of bridging lines. This knowledge is essential for a detailed understanding of the relationship between size and mobility in bridging spiders. Even more interesting, if confirmed, is the fact that spiders rely on minor ampullate silk fibres for bridging. Major ampullate silk fibres are thicker, stronger and stiffer: the breaking stress of major ampullate silk for *A. argentata* is 1495 MPa, and its breaking strain 0.205 (Blackledge & Hayashi 2006). If *A. argentata* used two major ampullate silk filaments for bridging, an adult female could bridge with a relative sag of less than  $k = 0.1$  and a safety coefficient of  $\beta = 2$ . Why, then, should spiders use minor ampullate silk filaments for bridging? Minor ampullate silk may form stronger attachments to the substrate, or it may be easier to initiate in the absence of any tension pulling the silk from the spider (Eberhard 1987).

## Acknowledgments

We thank D. Vinković, T. Blackledge and three anonymous reviewers for their helpful comments on previous versions of this ms. This work was supported by Ministerio de Ciencia e Innovación/FEDER (projects CGL2007-63223/BOS to MARG and CGL2007-60520/BOS to JML, and pre-doctoral grant FPI BES-2005-9234 to GC) and Junta de Andalucía/FEDER (project RNM-340).

## References

- Aisenberg,A., Viera,C. & Costa,F.G. 2007. Daring females, devoted males, and reversed sexual size dimorphism in the sand-dwelling spider *Alloca brasi liensis* (Araneae, Lycosidae). *Behavioral Ecology and Sociobiology* 62, 29-35.
- Blackledge,T.A., Coddington,J.A. & Gillespie,R.G. 2003. Are three-dimensional spider webs defensive adaptations? *Ecology Letters* 6, 13-18.
- Blackledge,T.A. & Hayashi,C. Y. 2006. Silken toolkits: biomechanics of silk fibers spun by the orb web spider *Argiope argentata* (Fabricius 1775). *Journal of Experimental Biology* 209 2452-2461.
- Blackledge,T.A., Scharff,N., Coddington,J.A., Szuts,T., Wenzel,J.W., Hayashi,C.Y. & Agnarsson,I. 2009. Reconstructing web evolution and spider diversification in the molecular era. *Proceedings of the National Academy of Sciences of the United States of America* 106 5229-5234.
- Brose,U., Jonsson,T., Berlow,E.L., Warren,P., Banasek-Richter,C., Bersier,L.F., Blanchard,J.L., Brey,T., Carpenter,S.R., Blandenier,M.F.C., Cushing,L., Dawah,H.A., Dell,T., Edwards,F., Harper-Smith,S., Jacob,U., Ledger,M.E., Martinez,N.D., Memmott,J., Mintenbeck,K., Pinnegar,J. K., Rall,B.C., Rayner,T.S., Reuman,D.C., Ruess,L., Ulrich,W., Williams,R.J., Woodward,G. & Cohen,J.E. 2006. Consumer-resource body-size relationships in natural food webs. *Ecology* 87, 2411-2417.
- Burnet,B. 1994. *The Silken Web. A Natural History of Australian Spiders*. Sydney: Reed New Holland Books.
- Coddington,J.A. & Levi,H.W. 1991. Systematics and evolution of spiders (Araneae). *Annual Review of Ecology and Systematics*, 22 565-592.
- Corcobado,G., Rodriguez-Girones,M.A., De Mas,E. & Moya-Laraño,J. 2010. Introducing the refined gravity hypothesis of extreme sexual size dimorphism. *BMC Evolutionary Biology*, 10, 236.
- Denny,M. 1976. Physical properties of spiders silk and their role in design of orb-webs. *Journal of Experimental Biology* 65, 483-506.
- Eberhard,W.G. 1987. How spiders initiate airborne lines. *Journal of Arachnology* 15, 1-9.
- Foelix,R.F. 1996. *Biology of Spiders*. Oxford, UK: Oxford University Press.

- Gosline, J.M., Guerette, P.A., Ortlepp, C.S. & Savage, K.N. 1999. The mechanical design of spider silks: From fibroin sequence to mechanical function. *Journal of Experimental Biology* 202, 3295-3303.
- Hayashi, C.Y., Blackledge, T.A. & Lewis, R.V. 2004. Molecular and mechanical characterization of aciniform silk: Uniformity of iterated sequence modules in a novel member of the spider silk fibroin gene family. *Molecular Biology and Evolution* 21, 1950-1959.
- Kitagawa, M. & Kitayama, T. 1997. Mechanical properties of dragline and capture thread for the spider *Nephila clavata*. *Journal of Materials Science* 32, 2005-2012.
- Kohler, T. & Vollrath, F. 1995. Thread biomechanics in the 2 orb-weaving spiders *Araneus diadematus* (Araneae, Araneidae) and *Uloborus walckenaerius* (Araneae, Uloboridae). *Journal of Experimental Zoology* 271, 1-17.
- Levi, H.W. 1971. The *Diadematus* group of the orb-weaver genus *Araneus* north of Mexico (Araneae: Araneidae). *Bulletin of the Museum of Comparative Zoology* 141, 131-179.
- Morse, D.H. & Fritz, R.S. 1982. Experimental and observational studies of patch choice at different scales by the crab spider *Misumena vatia*. *Ecology* 63, 172-182.
- Morse, D.H. 2007. *Predator upon a flower. Life history and fitness in a crab spider*. Cambridge, MA: Harvard University Press.
- Moya-Laraño, J., Vinkovic, D., De Mas, E., Corcobado, G. & Moreno, E. 2008. Morphological evolution of spiders predicted by pendulum mechanics. *PLoS One* 3, e1841.
- Ortlepp, C. & Gosline, J.M. 2008. The scaling of safety factor in spider draglines. *Journal of Experimental Biology* 211, 2832-2840.
- Osaki, S. 1996. Spider silk as mechanical lifeline. *Nature* 384, 419-419.
- Osaki, S. 2003. Safety coefficient of the mechanical lifeline of spiders. *Polymer Journal*, 35 261-265.
- Penney, D. 2004. Does the fossil record of spiders track that of their principal prey, the insects? *Transactions of the Royal Society of Edinburgh-Earth Sciences* 94, 275-281.
- Peters, H.M. 1990. On the structural and glandular origin of the bridging lines used by spiders for moving to distant places. *Acta Zoologica Fennica* 190, 309-314.
- Roesler, J., Harders, H. & Backer, M. 2007. *Mechanical behaviour of engineering materials*. Berlin: Springer.

- Selden,P.A., Shear,W.A. & Bonamo,P.M. 1991. A spider and other arachnids from the Devonian of New-York, and reinterpretations of Devonian Araneae. *Palaeontology* 34, 241-281.
- Shear,W.A., Palmer,J.M., Coddington,J.A. & Bonamo,P.M. 1989. A Devonian spinneret - Early evidence of spiders and silk use. *Science* 246, 479-481.
- Swanson,B.O., Blackledge,T.A., Summers,A.P. & Hayashi,C.Y. 2006. Spider dragline silk: Correlated and mosaic evolution in high-performance biological materials. *Evolution* 60, 2539-2551.
- Vollrath,F. & Selden,P. 2007. The role of behavior in the evolution of spiders, silks, and webs. *Annual Review of Ecology Evolution and Systematics* 38, 819-846.
- Vollrath,F., Madsen,B. & Shao,Z.Z. 2001. The effect of spinning conditions on the mechanics of a spider's dragline silk. *Proceedings of the Royal Society of London Series B-Biological Sciences* 268, 2339-2346.
- Woodward,G., Ebenman,B., Emmerson,M., Montoya,J. M., Olesen,J.M., Valido,A. & Warren,P.H. 2005. Body size in ecological networks. *Trends in Ecology & Evolution* 20, 402-409.



# MANUSCRIPT III

## Introducing the refined gravity hypothesis of extreme sexual size dimorphism

Guadalupe Corcobado<sup>1\*</sup>, Miguel A. Rodríguez-Gironés<sup>1</sup>, Eva De Mas<sup>1</sup>,

Jordi Moya-Laraño<sup>1,2</sup>

<sup>1</sup>Dpto. de Ecología Funcional y Evolutiva, Estación Experimental de Zonas Áridas, CSIC, Carretera de Sacramento, s/n. La Cañada de San Urbano, C.P. 04120. Almería, Spain.

<sup>2</sup> Cantabric Institute of Biodiversity (ICAB). Dpto. de Organismos y Sistemas. Universidad de Oviedo, Catedrático Rodrigo Uría, s/n, 33006-Oviedo, Spain.



Photo Eva de Mas

*BMC Evolutionary Biology* 2010, 10:236

## Resumen

**Antecedentes.** La búsqueda de explicaciones para entender la evolución del dimorfismo sexual en el tamaño (SSD de las siglas en inglés *Sexual Size Dimorphism*) extremo sesgado hacia las hembras (es decir, hembras mucho más grandes que los machos), que ha preocupado a los investigadores desde Darwin, todavía hoy genera controversia. Aquí se propone una extensión de la Hipótesis de la Gravedad (i.e., la HG, que postula que un menor tamaño es ventajoso para escalar), que junto con la hipótesis de la fecundidad podría suponer la hipótesis con mayor poder explicativo para la evolución del SSD propuesta hasta la fecha. En esta hipótesis de la gravedad-puenteo (en inglés "*Bridging Gravity Hypothesis*" or "*Bridging GH*") se propone que la locomoción por puenteo (es decir, desplazarse boca-abajo a través de puentes de seda fabricados por el propio individuos) podría estar detrás de la evolución del SSD extreme. Un modelo biomecánico muestra que las arañas muy grandes tienen una restricción física para puentear. Esto debería conllevar a trade-off entre algunos rasgos y la capacidad de dispersión, de modo que el puenteo favorecería tamaños pequeños mientras que otras fuerzas de selección (e.j. selección por la fecundidad en hembras) favorecería tamaños grandes. Si la capacidad para puentear permite dispersarse más rápido, los machos más pequeños tendrían una ventaja selectiva puesto que presentaría mayores oportunidades para aparearse. Se predice entonces que tanto machos como hembras grandes tendrían una menor tendencia a puentear, y que SSD estaría correlacionado negativamente con el dimorfismo sexual en la propensión a puentear. Para testar esta hipótesis, inducimos experimentalmente a puentear a machos y hembras de 13 especies pertenecientes a dos clados distintos donde la locomoción mediante puenteo ha evolucionado independientemente y donde se encuentran la mayoría de los casos de SSD extreme en arañas.

**Resultados.** Encontramos que 1) a medida que el SSD se incrementaba y las hembras alcanzaban tamaños más grandes, estas hembras tendían a puentear menos en relación a los machos de las mismas especies, y que 2) tanto los machos como las hembras más pequeñas mostraban una mayor propensión a puentear.

**Conclusiones.** Restricciones físicas hacen que las arañas grandes sean ineficientes puentearo. Así, en especies donde el puenteo es un modo de locomoción muy común, los machos pequeños, al ser más eficientes puenteadores, serán competitivamente superiores y presentarán mayores oportunidades de aparearse. Esta "*Bridging GH*" ayuda a solventar la controvertida pregunta de qué mantiene a los machos pequeños y contribuye también a explicar la amplio rango de patrones de SSD en arañas, ya que aquellas especies donde el SSD extreme no ha evolucionado, pero viven en habitats elevados sobre la vegetación, no usan el puenteo como un medio de locomoción para dispersarse.



## Abstract

**Background.** Explanations for the evolution of female-biased, extreme Sexual Size Dimorphism (SSD), which has puzzled researchers since Darwin, are still controversial. Here we propose an extension of the Gravity Hypothesis (i.e., the GH, which postulates a climbing advantage for small males) that in conjunction with the fecundity hypothesis appears to have the most general power to explain the evolution of SSD in spiders so far. In this “Bridging GH” we propose that bridging locomotion (i.e., walking upside-down under own-made silk bridges) may be behind the evolution of extreme SSD. A biomechanical model shows that there is a physical constraint for large spiders to bridge. This should lead to a trade-off between other traits and dispersal in which bridging would favor smaller sizes and other selective forces (e.g. fecundity selection in females) would favor larger sizes. If bridging allows faster dispersal, small males would have a selective advantage by enjoying more mating opportunities. We predicted that both large males and females would show a lower propensity to bridge, and that SSD would be negatively correlated with sexual dimorphism in bridging propensity. To test these hypotheses we experimentally induced bridging in males and females of 13 species of spiders belonging to the two clades in which bridging locomotion has evolved independently and in which most of the cases of extreme SSD in spiders are found.

**Results.** We found that 1) as the degree of SSD increased and females became larger, females tended to bridge less relative to males, and that 2) smaller males and females show a higher propensity to bridge.

**Conclusions.** Physical constraints make bridging inefficient for large spiders. Thus, in species where bridging is a very common mode of locomotion, small males, by being more efficient at bridging, will be competitively superior and enjoy more mating opportunities. This “Bridging GH” helps to solve the controversial question of what keeps males small and also contributes to explain the wide range of SSD in spiders, as those spider species in which extreme SSD has not evolved but still live in tall vegetation, do not use bridging locomotion to disperse.

## Introduction

Sex differences in body size, or sexual size dimorphism (SSD), are widespread across the animal kingdom (Darwin 1871; Andersson 1994; Abouheif & Fairbairn 1997; Fairbairn 2007), and hypothetically reflect the different selective pressures acting on males and females (Blanckenhorn 2000; Roff 2002). Female-biased SSD (females larger than males) is the most common pattern, typical in invertebrates and ectothermic vertebrates. Even though fecundity selection favoring large females (Darwin 1871; Head 1995) is the most accepted explanation for female-biased SSD, two questions remain unsatisfactorily solved. First, what selective pressures act on males in order to keep them small (Blanckenhorn 2000; Blanckenhorn 2005) in spite of the usually high genetic correlation between the sexes? (Lande 1980); and second, what factors are responsible for the wide range of variation in SSD present in nature? (Fairbairn et al. 2007).

SSD is widespread among spiders (Araneae). There is a general pattern of female-biased SSD which is highly variable among taxa (Fairbairn 1997; Hormiga et al. 2000; Foellmer & Moya-Laraño 2007). Additionally, spiders are the only group of free-living terrestrial organisms in which extreme SSD –i.e., females twice as large as males (Hormiga et al. 2000)-, is common, and in which this pattern has evolved several times independently (Hormiga et al. 2000). Most spider species exhibiting extreme SSD are found among Orbicularian spiders (especially in the families Tetragnathidae, Theridiidae and Araneidae) and the family Thomisidae within the RTA clade. However, some exceptional cases can be found in other taxa, including the Mygalomorphae (Main 1990). Hormiga *et al.* (Hormiga et al. 2000) in a study based on 9 families of Orbicularian spiders (526 species) found that 24 out of 76 genera showed female-biased extreme SSD and that extreme SSD had been gained and lost several times across the phylogeny. Vollrath & Parker (Vollrath & Parker 1992) found that in web-building spiders (7 families from the Orbiculariae clade plus the families Agelenidae and Atypidae -the latter belonging to the old Mygalomorphae clade-), 93 out of 159 species showed extreme SSD, and 17 out of

the 20 species of sampled Thomisidae also showed extreme SSD. In contrast none of the 41 species from the 7 families: Pisauridae, Lycosidae, Salticidae, Philodromidae, Sparassidae, Clubionidae and Gnaphosidae, showed extreme SSD (Vollrath & Parker 1992). Thus, spiders, especially those from the Orbicularian clade and the family Thomisidae, constitute a perfect system to study the evolution of extreme SSD.

In spiders, the most accepted hypothesis explaining the actual pattern of SSD is the fecundity selection hypothesis, by which females increase in size due to selection imposed on fecundity (Head 1995; Coddington et al. 1997; Prenter et al. 1999; Hormiga et al. 2000; Prenter et al. 2003). Nevertheless, this hypothesis does not offer a solid explanation for the wide range of SSD found across spiders. In particular, fecundity selection does not explain why there are some species in which males grow almost as giant as females while in others males stay small while females grow gigantic. Additionally, there is a strong controversy about which selective pressures act on male size and thus on the adaptative significance of SSD (Foellmer & Moya-Laraño 2007). In spiders, males and females share the same lifestyles until maturation. Following maturation males, which are generally the searching sex, change their lifestyle and start roaming, searching for females to mate with (Foelix 1996), but see (Aisenberg et al. 2007). As a consequence of this particular male lifestyle, many hypotheses have tried to explain the adaptive significance for the evolution of SSD in relation to male agility or the ability of males to find receptive females, which usually point to advantages of small body size (Darwin 1871; Huxley 1938; Ghiselin 1974; Elgar 1991; Vollrath & Parker 1992; Schneider et al. 2000; Moya-Laraño et al. 2002). However, a global and integrative explanation for the evolution of extreme SSD has not been achieved thus far (reviewed in Foellmer & Moya-Laraño 2007).

The gravity hypothesis (GH) (Moya-Laraño et al. 2002) links the evolution of extreme SSD with the capacity of males to move on vertical surfaces. The GH predicts that smaller males should be favored because they climb faster and, as a result, these males would have an advantage either by scramble competition (more mating opportunities) or natural selection (escaping from predators). Although there is some controversy around the GH (Brandt & Andrade 2007a; Moya-Laraño et al. 2007a; Moya-Laraño et al. 2007b; Brandt & Andrade 2007b; Prenter et al. 2010),

it has been shown that the relationship between climbing speed and body mass is curvilinear with an optimal body mass for climbing (Moya-Laraño et al. 2009). Consequently, it has been suggested that extreme SSD has evolved only in those species that 1) live in high habitats and 2) in which females are larger than the optimal climbing mass.

However, in species living in high habitats spiders do not only walk or climb to disperse: they also bridge. Bridging is a very common means of aerial locomotion in spiders (Moore 1977; Peters 1990; Peters & Kooor 1991) that has nevertheless been relatively neglected in the literature (but see Morse & Fritz 1982; Linn 2001; Anderson & Morse 2001; Moya-Laraño et al. 2008 *manuscript I of this thesis*; Bonte et al. 2009; Bonte 2009). To bridge, a spider releases a line of silk that the wind attaches to a distant plant, and after actively tensing the line by pulling it back with its legs, the spider crosses hanging upside-down from the line (Moya-Laraño et al. 2008 *manuscript I of this thesis*). Different sources of evidence support the hypothesis that the morphology (leg length relative to body size) of modern spiders (Araneomorphae) that hang upside-down from their webs, has evolved to facilitate bridging, allowing spiders to swing as pendulums from their silk threads (Moya-Laraño et al. 2008 *manuscript I of this thesis*). This finding suggests that bridging plays an important role in the life of some spider taxa (Peters 1990), and that during evolutionary time morphological adaptations to bridging locomotion should be expected in spiders that live in high places (Moya-Laraño et al. 2008 *manuscript I of this thesis*). Given that dispersal through bridging is very uncommon among very large individuals (GC and JML, *personal observations*), constraints on bridging could help to explain the evolution of SSD in spiders.

Morse & Fritz (Morse & Fritz 1982) hypothesized that heavy *Misumena vatia* females did not use bridging for long-distance dispersal because, due to the elasticity of silk, the sag of the fiber would bring the spiders down to the ground when they crossed their silk bridges. This hypothesis is confirmed by a biomechanical model showing that large spiders cannot use bridging as an efficient dispersal mechanism. Large spiders are limited to short bridging events or to bridging events that start high above the surface (Rodriguez-Girones et al. 2010 *manuscript II of this thesis*). Spiders have up to 5 different types of silk glands which spin fibrous silks

characterized by different mechanical properties and linked to distinct ecological functions (Hayashi et al. 2004; Blackledge et al. 2005; Blackledge & Hayashi 2006). The kind of silk used to bridge is spun in the minor ampullate glands (Peters 1990; Peters & Kovoor 1991). Some remarkable properties of this kind of silk are the thin diameter of its fibers, their low strength and their high extensibility (Blackledge & Hayashi 2006). Although spiders have some control on the diameter of their minor ampullate silk fibers (Eberhard 1987), as well as the diameter of other types of lines (eg. Vollrath & Kohler 1996; Vollrath et al. 2001; Garrido et al. 2002; Tso et al. 2007; Blackledge & Zevenbergen 2007), phenotypic plasticity in thread diameter is severely limited (Vollrath 1999), possibly constraining the ability of large spiders to bridge. Thus, while giant female spiders perform short bridging events during web building (Peters 1990), large adult web-building spiders move less often and shorter distances than juveniles (Lubin et al. 1993). This could be due to the fact that large spiders are not able to bridge long distances efficiently (Rodriguez-Girones et al. 2010 *manuscript II of this thesis*).

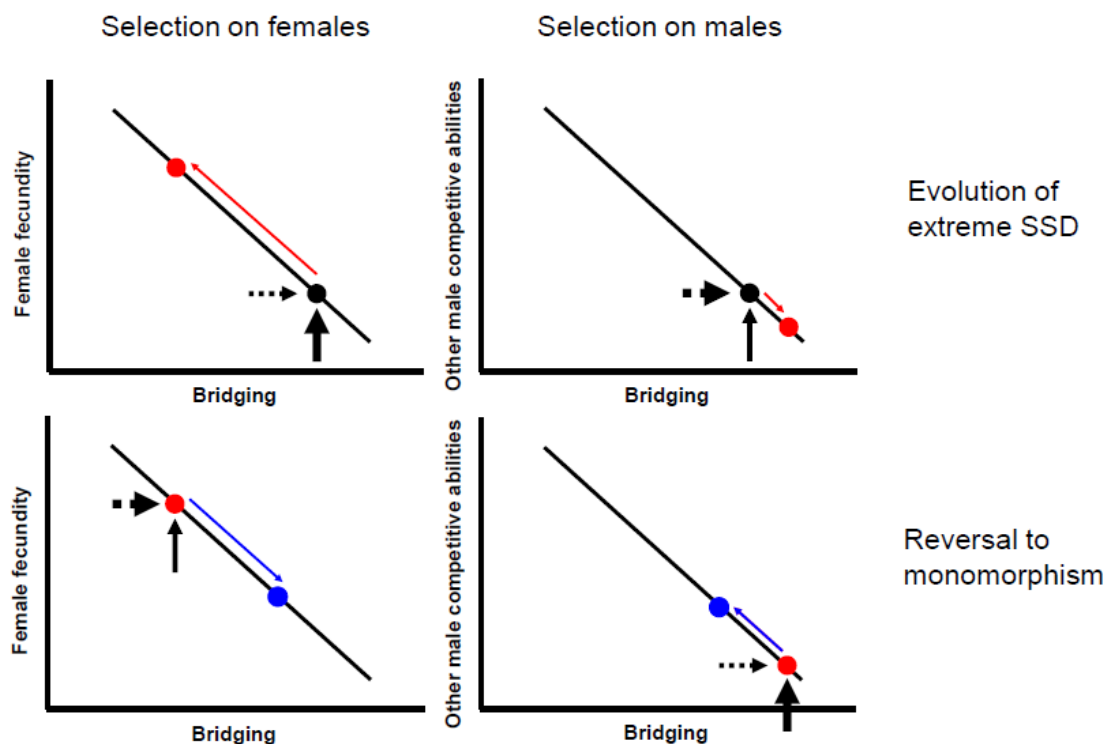
It is easy to see how a small size could be favored in habitats in which bridging is the most frequent mode of locomotion. If large spiders forego bridging, they will have to walk along leaves, twigs and branches, climbing down to the ground, walking towards their target and climbing up again. Other than the extra time and energy expended by climbing up and down, this implies an increase in the length of their trajectory. In addition, once spiders are morphologically adapted to bridge, this would be particularly disadvantageous, as their ill-adapted morphology makes large spiders clumsy walking on the ground (Moya-Laraño et al. 2008 *manuscript I of this thesis*). If, on the other hand, these large spiders choose to bridge, the short distance they can span in a single bridging event will force them to perform a greater number of bridging events to cover the same distance, as compared to smaller individuals, thus expending more time and energy by having to build more lines (Moya-Laraño et al. 2008 *manuscript I of this thesis*). Bridging imposes a final cost on large spiders linked to the GH of SSD (Moya-Laraño et al. 2002; Brandt & Andrade 2007a; Moya-Laraño et al. 2007a; Moya-Laraño et al. 2007b; Brandt & Andrade 2007b; Moya-Laraño et al. 2009; Prenter et al. 2010). The actual trajectory of a spider during bridging has some resemblance with an inverted parabola: from the midpoint on, spiders must actually climb to reach their goal. If

climbing speed decreases in spiders of relatively large mass, as a few studies have shown, (Moya-Laraño et al. 2002; Moya-Laraño et al. 2007a; Moya-Laraño et al. 2009), large size will be disadvantageous during the final stages of bridging. Even though some studies have failed to find a negative relationship between body size and climbing speed in spider males (Brandt & Andrade 2007a; Prenter et al. 2010), the lack of this pattern in males, which exhibit a small range of variation in size than females, could be the product of the “ghost of the evolution past” (Blanckenhorn 2005). This would imply that we could not find a climbing disadvantage for larger males because the sizes of extant males fall below the threshold beyond which body size constraints climbing speed. Indeed, using a sufficiently wide range of body sizes, researchers showed that the relationship between climbing speed and this trait has an optimum at intermediate value, after which climbing speed decreases with body size, as predicted by the GH (Moya-Laraño et al. 2009).

Given that males are the searching sex in spiders (Foelix 1996), selective pressures on morphological traits enhancing mobility in general, and bridging in particular, should be much stronger in males than in females. Hence, in species living in high habitats, where bridging is a common mode of locomotion (Moore 1977; Peters 1990; Peters & Kooor 1991; Linn 2001), being a good “bridger” could be adaptive for males, since they could be favored from sexual selection by scramble competition. Previous studies have already suggested the advantage of more mobile males related to scramble competition in spiders with extreme SSD as well as the implications in the evolution of SSD (Legrand & Morse 2000; Linn 2001; Moya-Laraño et al. 2002; Ramos et al. 2004). Considering the biomechanical constraint of the model mentioned above and the low rate at which giant females seem to bridge, we hypothesise that there should be a negative relationship between body size and bridging ability and that this bridging constraint should have played a role in the evolution of extreme SSD in spiders. In this paper we test these hypotheses.

A more comprehensive way to introduce these predictions is assuming a trade-off between traits positively correlated to body size and traits negatively correlated to body size (Fig. 1). Assuming heritability in body size, if bridging is negatively correlated with body size and other traits are positively correlated with large size, such as fecundity in females (Head 1995), and in males walking on the

ground (Brandt & Andrade 2007a) and/or advantages in male-male contest competition (Elgar 1998), two scenarios are possible, the evolution of extreme SSD and the evolution from extreme SSD to reversed monomorphism (Hormiga et al. 2000). The evolution of male and female body sizes along the trajectory of the trade-off will depend on the direction and magnitude of the net effect of opposing selective forces, those that favor a large body size on the one hand and those that favor a small body size on the other. Furthermore, this net effect of opposing selective forces will also have to overcome the genetic correlation between the sexes (Lande 1980) for extreme SSD to evolve. Reversal to monomorphism could evolve in environments in which dispersal by bridging is more important in females than fecundity (such as highly unpredictable environments for prey availability) and/or contest competition or walking on the ground is more important than bridging for



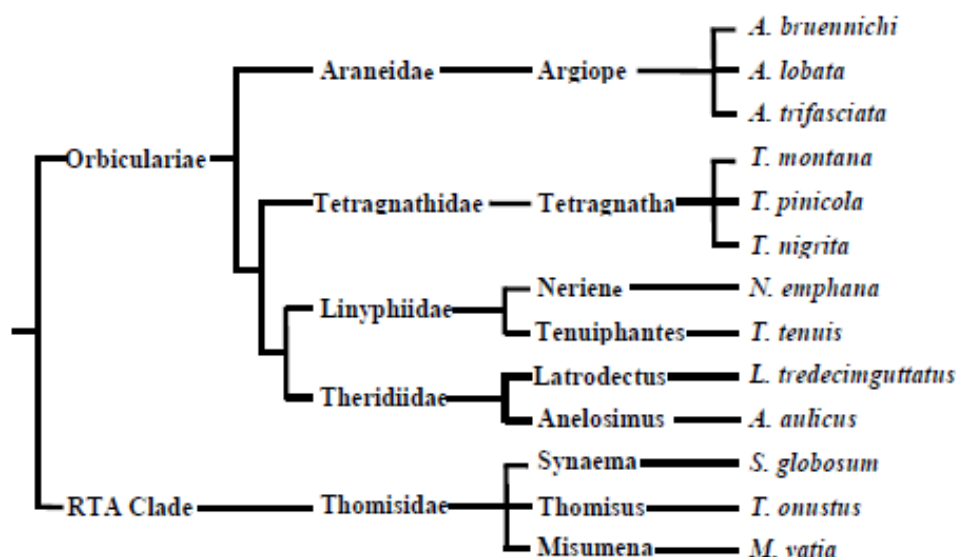
males (such as habitats with sparse vegetation).

#### Figure 1: Size-mediated trade-offs involving bridging ability

How a size-mediated trade-off between fecundity and bridging ability (females) and a size-mediated trade-off between other male competitive abilities (e.g. walking on the ground, male-male contest competition) and bridging ability (males) can lead to the evolution of extreme SSD and the reversal to monomorphism. Black circles, ancestral bi-variate trait; Red circles, trait values after the response to opposite selection in females and males; Blue circles, values after response to selection converging to similar female and male sizes. The horizontal dotted arrows denote the strength of selective forces (i.e. favouring bridging) decreasing body size and the vertical solid arrows denote the strength of selective forces increasing body size. The red and blue arrows denote the trajectories of the response to selection along the trade-off line. When fecundity selection in females is stronger than selection for dispersal, female gigantism evolves. When selection for dispersal by bridging is stronger in males, male dwarfism evolves. The joint effect is the evolution of extreme SSD. Similarly, when

dispersal is favoured over fecundity in females and other male competitive abilities are favoured over bridging in males, reversal to monomorphism will evolve.

Here we use bridging propensity, i.e., the probability of building a bridging line and crossing it by walking upside-down under laboratory conditions of constant wind speed, as a proxy for the ease with which spiders can bridge in nature. The rationale of the approach is that if larger spiders have a stronger constraint for bridging, then selection should have favored a lower propensity to disperse by this mechanism in larger individuals. We measured bridging propensity in laboratory conditions for adult males and females of 13 spider species of considerable phylogenetic diversity (Table 1; Fig. 2), both within the Orbicularian clade and the family Thomisidae –RTA clade–, covering a broad range of spider body sizes (Table 1). After the trials were finished all the spiders were weighed and their carapace width (CW) measured. To analyze the data we used phylogenetically controlled analyses. We predicted that i) SSD would explain sex differences in bridging propensity, in the sense that when both males and females are small and of similar size both would bridge at the same rate, but when females start growing to a large size and males remain relatively small, then females would bridge at a much lower rate; ii) there is a negative relationship between body size and the probability of bridging for both males and females.



**Figure 2: Phylogeny of the spiders used for the analysis comparing sex differences in bridging propensity to SSD**

This phylogeny was rebuilt using published information for the different taxa. .



**Table 1:** Average Body Mass and Carapace Width (CW) for males and females of each species (Values are Mean  $\pm$  SD). Bridging propensity is the proportion of females or males that bridge.

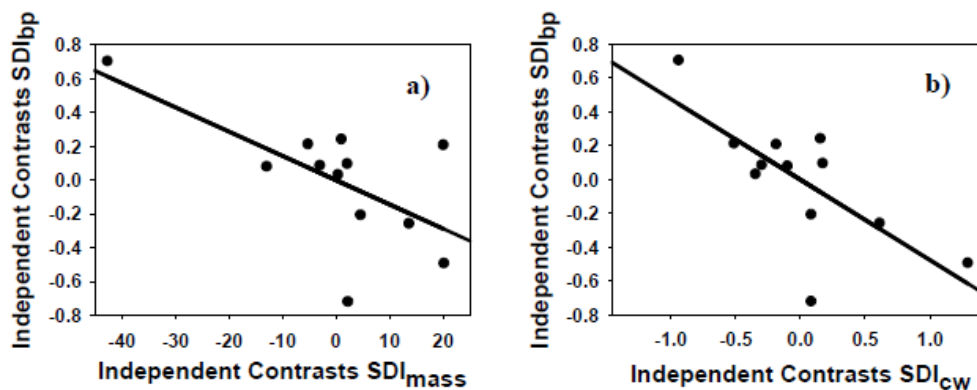
Species	Sex	n	Mass (mg)	CW (mm)	Bridging propensity	SDI mass	SDI CW
<i>Argiope bruennichi</i>	female	2	546.500 $\pm$ 406.304	4.689 $\pm$ 0.544	0	24.718	1.095
	male	2	21.250 $\pm$ 0.778	2.238 $\pm$ 0.057	1		
<i>Argiope lobata</i>	female	21	982.224 $\pm$ 406.480	6.112 $\pm$ 0.535	0	39.178	1.375
	male	19	24.447 $\pm$ 4.166	2.573 $\pm$ 0.107	0.842		
<i>Argiope trifasciata</i>	female	1	341.500	4.997	0	12.837	1.607
	male	1	24.680	1.917	1		
<i>Tetragnatha montana</i>	female	5	52.140 $\pm$ 5.553	2.052 $\pm$ 0.100	0	1.427	0.122
	male	5	21.480 $\pm$ 4.452	1.830 $\pm$ 0.072	1		
<i>Tetragnatha pinicola</i>	female	3	33.067 $\pm$ 9.139	1.870 $\pm$ 0.007	1	0.886	0.131
	male	10	17.530 $\pm$ 10.123	1.653 $\pm$ 0.143	1		
<i>Tetragnatha nigrita</i>	female	1	7.950	1.265	1	-0.094	0.145
	male	1	8.700	1.449	1		
<i>Neriene emphana</i>	female	5	20.280 $\pm$ 0.733	1.544 $\pm$ 0.054	0.4	4.965	0.173
	male	1	3.400	1.316	1		
<i>Tenuiphantes tenuis</i>	female	4	0.748 $\pm$ 0.788	0.770 $\pm$ 0.051	1	0.459	0.023
	male	11	0.482 $\pm$ 0.417	0.753 $\pm$ 0.036	1		
<i>Latrodectus tredecimguttatus</i>	female	14	522.707 $\pm$ 158.910	5.179 $\pm$ 0.356	0	27.488	1.872
	male	12	18.348 $\pm$ 4.493	1.803 $\pm$ 0.181	0.833		
<i>Anelosimus aulicus</i>	female	13	4.627 $\pm$ 2.500	1.013 $\pm$ 0.064	1	0.941	0.015
	male	3	2.383 $\pm$ 0.252	0.998 $\pm$ 0.019	1		
<i>Synaema globosum</i>	female	24	35.098 $\pm$ 13.758	2.164 $\pm$ 0.250	0.625	5.470	0.267
	male	16	5.425 $\pm$ 2.236	1.707 $\pm$ 0.124	0.875		
<i>Thomisus onustus</i>	female	14	257.025 $\pm$ 127.050	3.859 $\pm$ 0.415	0.071	59.150	1.513
	male	16	4.003 $\pm$ 1.162	1.539 $\pm$ 0.105	0.875		
<i>Misumena vatia</i>	female	2	151.750 $\pm$ 11.809	3.304 $\pm$ 0.480	0	59.700	1.263
	male	1	2.500	1.460	1		

## Results

### Bridging propensity vs. SSD

As predicted, we found a negative relationship between SSD and sexual dimorphism in bridging propensity. The phylogenetically controlled GLS analysis showed that the differences in bridging propensity across species were significantly

explained by SSD, whether measured as body size (CW,  $t_{11} = -3.296$ ,  $p = 0.004$ ) or as body mass ( $t_{11} = -2.440$ ,  $p = 0.016$ ). This relationship was negative for both variables (Fig. 3, see also tables A1, A2 in Supporting Information 1, and Fig. A1 in Supporting Information 2), which implies that when females are much larger than males, males bridge at higher rates relative to females (see Methods below for a more detailed explanation of how the SDI index was built). The variation of the GLS analyses including male bridging propensity as well as female and male body size as independent variables, with female bridging propensity as the dependent variable, also revealed that SSD was negatively related to differential bridging propensity. After controlling for male body size and male bridging propensity, female body size was negatively related to female bridging propensity for both CW and body mass ( $t_9 = -3.059$ ,  $p = 0.007$  and  $t_9 = -3.631$ ,  $p = 0.003$ , respectively; Fig. 4, table A3 in Supporting Information 1). Taken together, our results show that a lower bridging propensity of females is linked to stronger female-biased SSD across taxa.



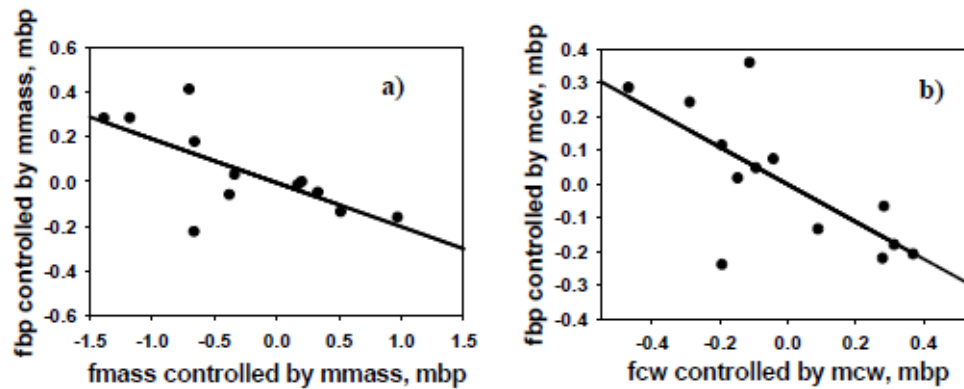
**Figure 3: Sex differences in bridging propensity ( $SDI_{bp}$ ) vs. SSD ( $SDI_{SSD}$ )**

SSD was measured as an SDI index either using body mass **(a)** or carapace width **(b)**. Also an SDI index was calculated for sex differences in bridging propensity (see text for more details about how the SDI index is built). The plots show the linear relationship between SSD –**a)**  $SDI_{mass}$ ; **b)**  $SDI_{CW}$ – and sex differences in bridging propensity ( $SDI_{bp}$ ). Points are independent contrasts.

### **Bridging propensity vs. size in females and males**

Both females and males tended to bridge less when larger. The GLS analyses ran separately for females showed that female size, measured either as CW or body mass, explained the proportion of bridging females, with the larger taxa having a lower propensity to bridge (Female mass:  $t_{11} = -4.751$ ,  $p < 0.001$ ; Female CW:  $t_{11} = -4.528$ ,  $p < 0.001$ ; Fig. 5a, 5b). Likewise, males with wider carapaces were

significantly less prone to bridge (Male CW:  $t_{11} = -2.350$ ,  $p = 0.019$ ), and a negative relationship was also found for body mass, although this last relationship was only marginally significant (Male mass:  $t_{11} = -1.668$ ,  $p = 0.061$ ; Fig. 5c, 5d; see also tables A4, A5 in Supporting Information 1, and Fig. A2 in Supporting Information 2). The slopes for males and females (tables A4 and A5 in Supporting Information 1) differ in almost one order of magnitude, being those of males much flatter than those of females. Actually, when we combined males and females in the same GLS analysis we found a significant interaction between sex and body size, measured either as mass ( $t_{22} = -3.093$ ,  $p = 0.003$ ) or CW ( $t_{22} = -2.516$ ,  $p = 0.020$ ; table A6 in Supporting Information 1).



**Figure 4: Multivariate Generalized Least Squares (GLS) approach to test for a relationship between SSD and sex differences in bridging propensity.**

**a)** Partial regression plots between female bridging propensity (fbp) in the y axis and female body mass (fmass) in the x axis, controlled for male body mass (mmass) and male bridging propensity (mbp). **b)** carapace width is used instead of body mass; fcw, female carapace width; mcw, male carapace width. All variables were log-transformed (see text for more details).

### Empirical probability of bridging as a function of size

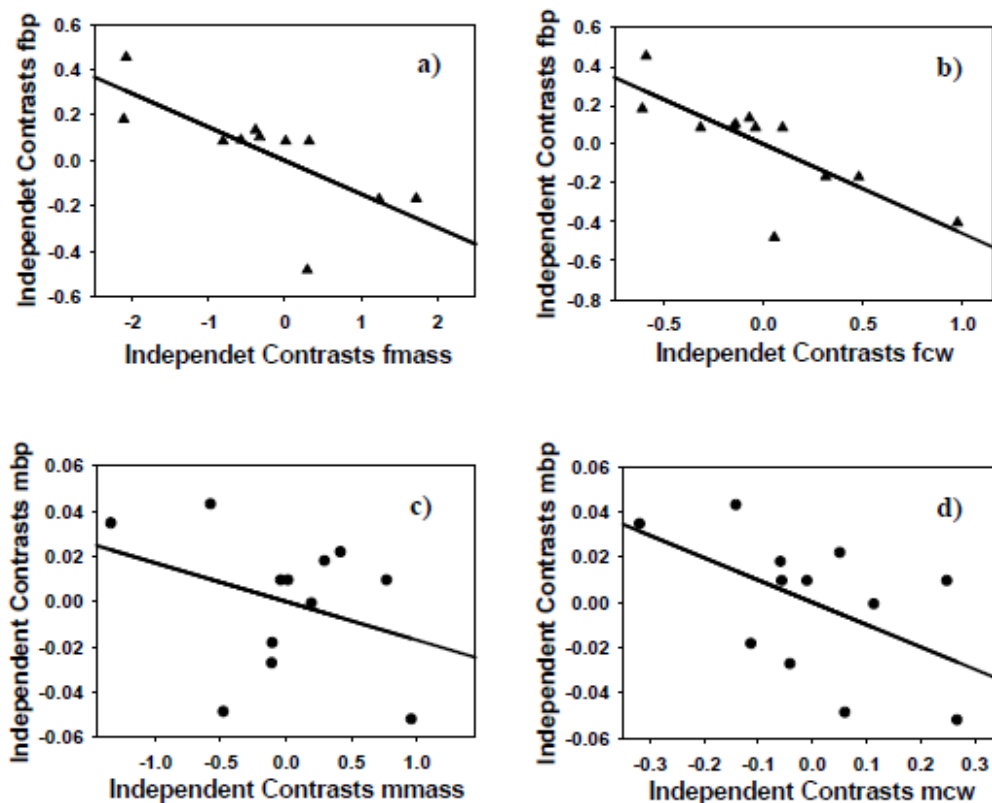
Fig. 6 shows the predicted probability of bridging extracted from logistic regressions using body mass (Fig. 6a) and body size (CW, Fig. 6b) as predictor variables. The logistic regression equations are

$$P = \frac{1}{1 + \exp[-(2.59896 - 0.04685 \cdot m)]} \quad (1)$$

and

$$P = \frac{1}{1 + \exp[-(5.29266 - 1.97352 \cdot CW)]} \quad (2)$$

respectively, where body mass,  $m$ , is expressed in mg and carapace width,  $CW$ , in mm. These equations can be used to determine the maximum body mass and size beyond which spiders do not bridge. We define the bridging threshold as the body mass or size beyond which the probability of bridging declines below 0.05. Setting  $P = 0.05$  in equations 1 and 2 and solving for  $m$  and  $CW$ , we obtain that spiders in our sample size were very unlikely to bridge if their body mass was greater than 118.32 mg (95% CI: 76.30 – 259.41) or their carapace was wider than 4.17 mm (95% CI: 2.97 – 6.42) (Fig. 6).



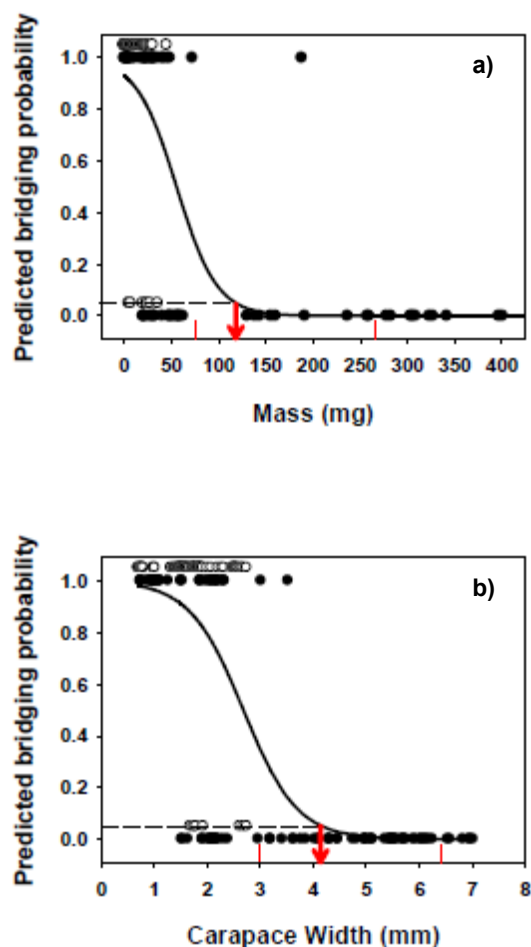
**Figure 5: Relationship between body size and bridging propensity.**

Plots show the relationship between either body mass (mass) or carapace width (CW) and bridging propensity (bp) for both sexes. **a)** female bp (fbp) vs. body mass (fmass); **b)** female bp (fbp) vs. female CW (fcw), **c)** male bp (mbp) vs. male body mass (mmass) **d)** male bp (mbp) vs. male carapace width (mcw). All variables were log-transformed (see text for more details). Points are independent contrasts.

## Discussion

As we predicted following our extended version of the GH, SSD (measured using CW or body mass) clearly explains the different bridging abilities between males and females, suggesting that in species living in high habitats, selection has favored small size in males via the enhancement of bridging. Due to the genetic correlation in body size between the sexes, this force acting upon males should have been strong enough to overcome the strong fecundity selection acting on females, which is the driving force of female gigantism. Our results show that in species where females are small and of similar size to males (low SSD), both sexes bridge at a similar, and substantially high rate, but when SSD increases and females become much larger than males, these relatively giant females stop using bridging to move, while males keep bridging at a very high rate. This pattern showing that large body size constrains bridging is also found when we analyze the sexes separately. Thus, body size alone can explain a large part of the variation on the proportion of females that bridged across species. Although we found the same trend in males, the results tended to be less clear – probably because the size of all males examined was too low to severely constrain bridging locomotion (see Fig. 6) and a high proportion of males bridged even in the largest species. Therefore, within bridging species, the current body size distribution of male body sizes could be the product of the “ghost of the evolution past” (Blanckenhorn 2005), which refers to the fact that the evolutionary processes that we can measure today do not necessarily reflect adaptive evolution occurring in the past (see also Moya-Laraño et al. 2007b). In other words, if we measure natural selection within a species in nature, and find that smaller sizes are not favored during mate search, the underlying reason could be that all male sizes fall below the bridging threshold, and this by no means would mean that selection for bridging had not originated the pattern of SSD in the evolutionary past (see however an example below suggesting bridging selection against large males in natural conditions), but rather that past selection has been stronger in males (see evidence for this below). The strength of the evolutionary comparative method relies precisely in comparing species (or taxa), allowing

expanding the range of variation of traits and thus increasing the chances of detecting adaptive patterns. Together, our results confirm a size-mediated trade-off involving bridging which leads to the evolution of extreme SSD. In species living in high habitats, selection would have favored a small size in males via the enhancement of bridging. By contrast, in females, a relatively low environmental stochasticity in prey availability would select for fecund (and thus large) females that would need to disperse relatively little, leading to the evolution of extreme SSD. A reversal to monomorphism could also occur when an increase in environmental stochasticity for prey availability selects for high dispersal rates in females or when male-male contest competition or other dispersal modes favoring a large size become more important for males. The fact that the slope of the relationship between size and bridging propensity is much steeper in females than in males also supports the hypothesis that selection in the past has been much stronger in males than in females, making the slope of the trade-off to tilt up in males (Roff & Fairbairn 2007).



**Figure 6: Effects of spider size on the probability of bridging.**

Plots show the probability of bridging predicted by logistic regressions (continuous line) using either **a)** body mass or **b)** carapace width as predictor variables. Each dot corresponds to the trial of one single individual (females solid circles, males empty circles). To distinguish between males and females, successful bridging takes the value of 1 for females and 1.05 for males, while unsuccessful bridging takes the value of 0 for females and 0.05 for males. The red arrows show the threshold beyond which the predicted probability of bridging is less than 5%, and the red small vertical lines mark the limits of the confidence interval for this threshold.

A question remaining to be tested would be whether the evolution of SSD is a cause or a consequence of bridging dispersal in elevated habitats. Although the final answer will have to wait for a larger study than this one, including species with and without SSD, with and without bridging dispersal, our data suggest that selection to preserve bridging in males has induced SSD when female size has increased. At least in the Orbicularian clade, the ancestral state would be small males and females (Hormiga et al. 2000), and we can hypothesize that both sexes bridged (certainly the males: males bridge in all Orbicularian species that we have tested). If this was indeed the ancestral state, it follows that through the evolution of the clade females of different species have repeatedly and independently foregone bridging because the advantages of increasing body size (increased fecundity) were larger than the costs of losing mobility. Males, on the other hand, have remained small enough to bridge. In this scenario, SSD is the result of two selective pressures: on females to increase their fecundity (Hormiga et al. 2000) and on males to retain their bridging ability. For the family Thomisidae, on the other hand, the lack of a resolved phylogeny and the paucity of our data preclude us from advancing even a preliminary answer to the question. However, the hypothesized trade-off in Fig. 1, and the evidence supporting it in this paper, suggests that bridging would have always preceded the evolution of extreme SSD, as this is a plausible scenario in which opposing selection for large size in females and small size in males leads to extreme SSD. It is more difficult to think about a possible reversed scenario, in which extreme SSD would lead to an increase in sex differences of bridging propensity.

The mechanical properties of the silk prevent large spiders from bridging (Rodríguez-Girones et al. 2010 *manuscript II of this thesis*), and the threshold of 118.32 mg observed in our data (beyond which the probability of bridging is less than 5%) is in good agreement with the biomechanical model, which predicts that bridging should be constrained beyond masses of 100 mg. Consequently extreme SSD can be expected in high habitats and in those bridging species in which females are larger than the threshold to bridge efficiently, even if they live just barely above the ground. Beyond the bridging threshold, females can still evolve to be larger (due to the advantages originated from fecundity selection), but males will not. Hence, this bridging constraint and the associated trade-off (Fig. 1) would decelerate the rate of male and female body size coevolution, relaxing the genetic correlation of

body size between the sexes and leading eventually to the evolution of extreme female-biased SSD.

In addition, there is some evidence suggesting that silk properties also depend on the feeding condition of the spider, as starved spiders produce silk of worse quality (Madsen et al. 1999). This fact would be particularly relevant to females since they must allocate their nutritional and energetic resources not just to produce silk for bridging, but also in the production of offspring and silk for the egg sac (Vollrath 1999). Thus, beyond a certain body size threshold, this reproductive trade-off could have also favored females that do not use bridging locomotion and save resources to invest in reproduction, particularly when fecundity selection is the main driving force of body size. Males, on the other hand, by being released from fecundity selection, could be favored by having large protein reserves to spin the necessary silk to move around at the price of having the burden of carrying heavier body masses during mate search, which has been shown to be detrimental for bridging (Ramos et al. 2004). Alternatively, selection could favor a smaller size that would allow males to bridge efficiently without having a high demand of nutrients. Assuming that the cost of energy and nutrient expenditure of smaller males is relatively less than the benefit of bridging more efficiently, we propose that the second explanation is more likely to be true.

The hypothesis that selection favoring bridging efficiency in males has been responsible for the evolution of extreme SSD is not incompatible with other hypotheses that explain selection on small males. On the contrary, we suggest that our hypothesis is complementary. For example, the Differential Mortality Model predicts that smaller males are favored because the high predation risk that males suffer during mate searching relaxes male-male contest competition for females, and ultimately selection favoring large males. This in turn favors early maturation because it improves male viability and his chances to reproduce (Vollrath & Parker 1992; De Mass et al. 2009). Certainly, direct selection favoring smaller bridging males and indirect viability selection also favoring smaller males can work synergistically. The GH (Moya-Laraño et al. 2002) also predicts that small males are favored because they move faster in vertical surfaces. Additionally, a recent revision of this hypothesis shows a curvilinear relationship between body mass and climbing



speed, proposing that extreme SSD would have evolved in species where females live in high habitats and are larger than the optimal body mass for climbing (Moya-Laraño et al. 2009). Whether selection for fast climbing or efficient bridging has been stronger over evolutionary time depends on how often spiders use each of these two kinds of locomotion, and also on how often they walk on the ground, which has actually been shown to favor relatively larger males (Brandt & Andrade 2007a; Prenter et al. 2010). These different sources of selection need to be evaluated with field work. Nonetheless, as far as we know, there is only one study (using males of *Nephila clavipes*) that has evaluated different kinds of locomotion in spiders, and this study shows that bridging is by far the most frequent mechanism used to move and that smaller males are favored at finding mates (Linn 2001). However, we would like to stress that this extended version of the Gravity Hypothesis, also considering bridging locomotion, supports the more global explanation that in general gravity is an important factor to explain the evolution of extreme SSD. Furthermore, this “Bridging GH” even explains the exceptional cases in which there is no extreme SSD in species with relatively giant females living on relatively tall vegetation, as it is the case for some species within the families Theraphosidae, Ctenidae, Oxyopidae and Sparassidae. The absence of extreme SSD in these taxa could be related to the fact that these species have not evolved bridging capabilities or bridging morphologies (Moya-Laraño et al. 2008 *manuscript I of this thesis*) and consequently the selective pressures to keep males small would be less strong. Finally, our hypothesis and the fecundity selection hypothesis (Head 1995) are not mutually exclusive either, as the second only explains why females are large, not why males are relatively small in some species with large females and not in others. Rather, a bridging-fecundity trade-off acting on females can help to explain the evolution of extreme SSD (Fig. 1).

## Conclusions

Bridging is a neglected dispersal mode that can explain the evolution of extreme SSD in spiders. Physical constraints make bridging inefficient for large

spiders. Thus, in species where bridging is a very common mode of locomotion, small males, by being more efficient bridgers, will enjoy more mating opportunities and thus will be better at scramble competition to reach receptive females. While there is general agreement that fecundity selection increasing female size is quantitatively the most significant factor that can explain the actual pattern of SSD in spiders (Head 1995; Coddington et al. 1997; Prenter et al. 1999; Hormiga et al. 2000) our hypothesis helps to solve the controversial question of what keeps the males small (Blanckenhorn 2000), and also contributes to explain the wide range of SSD in spiders, which the fecundity hypothesis cannot explain. Hence, extreme SSD should always be expected in species that commonly use bridging locomotion and in which females are large and have a low need to disperse.

## Materials and Methods

### Spider collection

We collected adult male and female spiders in four different areas: Cabo de Gata and Punta Entinas (Almería, South East Spain), Cadí-Moixeró Natural Park (Pyrenees, North East Spain) and Region of Villuercas-Ibores (Extremadura, South West Spain) between May 2006 and May 2007. We selected our samples from the two independent clades in which most of the examples of extreme SSD are found, Orbiculariae and the family Thomisidae within the RTA Clade (Hormiga et al. 2000). Preliminary data from a study including temperate spiders of about 58 genera and 21 families across the entire spider phylogeny (Agelenidae, Amaurobiidae, Dictynidae, Dysderidae, Gnaphosidae, Linyphiidae, Lycosidae, Miturgidae, Oecobiidae, Oxyopidae, Philodromidae, Pholcidae, Pisauridae, Salticidae, Sparassidae, Teraphosidae, Tetragnathidae, Theridiidae, Thomisidae and Titanoeceidae) show that bridging locomotion has been detected only in one additional clade to those included here: the Dictynidae (Corcobado & Moya-Laraño *unpublished data*). The fact that there is a considerable overlap between the clades where most cases of extreme SSD are found and those where bridging has been recorder so far, suggests a possible link between the distribution of bridging

locomotion and that of extreme SSD across spiders. Within the two selected clades, we chose our sample in order to maximize phylogenetic diversity and to include those taxa with a body shape (relationship between leg lengths vs. body size) that suggested bridging locomotion (Moya-Laraño et al. 2008 *manuscript I of this thesis*). In total, the dataset comprised a total of 204 individuals from 13 species: *Argiope bruennichi*, *Argiope lobata* and *Argiope trifasciata* (Araneidae), *Tetragnatha montana*, *Tetragnatha pinicola* and *Tetragnatha nigita*. (Tetragnathidae), *Neriene emphana* and *Tenuiphantes tenuis* (Linyphiidae), *Latrodectus tredecimguttatus* and *Anelosimus aulicus* (Theridiidae), *Synaema globosum*, *Thomisus onustus* and *Misumena vatia* (Thomisidae). Our sample of species covered a wide range of body sizes, including almost the entire range for temperate web-building spiders (Roberts 1995): Females - Carapace Width (CW) 0.7-7.02mm, Body Mass 0.2-1846.6 mg; Males - CW 0.7-2.75 mm, Body Mass 0.3-44.8 mg.

### **Bridging trials**

All spiders were kept in the laboratory in jars of variable size adjusted to their own size until the trials were performed. All trials were performed at room temperature, during the day and within the next 24-72 hours after the spiders had been collected. Temperature during the bridging trials, time of day when the trials were run and time elapsed since the spiders were captured had no significant effect in our response variable and thus we did not include them in further analyses. We followed the methods described in Moya-Laraño et al. (Moya-Laraño et al. 2008 *manuscript I of this thesis*) to experimentally induce bridging in the laboratory, with minor modifications to adapt the system to our larger range of spider sizes. We placed a blowing fan 3.3 m away from a plant fragment and released the spider on top of a wire stand 27 cm height, which was located between the plant and the fan (30 cm away from the plant and 3 m away from the fan). The fan produced an air flow with a speed of 0.6 – 0.8 m·s<sup>-1</sup> blowing on the top of the wire stand. All trials were recorded with a video-camera for as long as 5 minutes. Our response variable was whether the spider bridged or not. If spiders did not start releasing silk for a bridge within the first 2 minutes, we induced spiders to do so by poking them gently a few times with a paint brush. Trials were finished when the spider reached the

plant after a successful bridging or 3 minutes after we first poked them, whatever came first. Of the 126 spiders that bridged, 61 needed to be poked before they started bridging. Notice that this allowed us to be sure that all spiders were motivated to bridge if they could do so. Thus, all spiders were likely responding to a potential predatory threat, the difference being that some of them responded immediately upon handling and others needed to be specially “threatened”. After trials were finished all the spiders were weighed with a precision balance to the nearest 0.1 mg or 0.01mg (smaller spiders were weighed with higher precision). The spiders collected in Almería were weighed alive after the trials, and then killed by freezing. The rest of the spiders were frozen after the trials and carried to the laboratory to be weighed as frozen individuals. Previously, we had verified that there was almost no difference between the weight of alive or frozen spiders (Repeatability between measurements – alive vs. frozen:  $R > 0.99$ ;  $p < 0.001$ ;  $n = 28$ ). All spiders were preserved in 70% ETOH after weighing. We measured the size of specimens (CW) under a dissection microscope. All animals were measured by the same observer (GC) with high intra-observer repeatability:  $R = 0.94$ ;  $p < 0.001$ ;  $n = 20$ .

### **Statistical Analyses**

*Measurement of Sexual Size Dimorphism (SSD).* SSD was estimated from CW and body mass. CW is fixed at maturation and does not change with the feeding status of the spider (reviewed in (Foellmer & Moya-Laraño 2007)), while body mass is a more dimorphic and plastic character (e.g. Prenter et al. 1995; Foellmer & Moya-Laraño 2007) that needs to be investigated because some biomechanical properties of the spider silk suggest that body mass is the trait that could constrain the ability to bridge efficiently (Rodríguez-Girones et al. 2010 *manuscript II of this thesis*). We used the modified ratio index or SDI (Lovich & Gibbons 1992) to measure SSD because of its good statistical properties (Fairbairn et al. 2007). This index is estimated by taking the ratio of the larger to the smaller sex minus 1, and then assigning a negative value if males are the larger sex, and a positive value if females are larger. The index takes a value of 0 when there is no SSD.

*Comparative Analysis.* To analyze the data across species we used a type of Generalized Least Squares (GLS) that incorporates phylogenetic relationships to correct for non-independence due to common ancestry (Grafen 1989). The GLS analysis was implemented in R using the package PHYLOGR (Diaz-Uriarte & Garland 2007). We rebuilt the phylogeny for the species included in our data using published partial phylogenies (Hormiga et al. 2000; Arnedo et al. 2004; Agnarsson 2004; Miller & Hormiga 2004; Coddington 2005; Alvarez-Padilla 2007; Benjamin et al. 2008; Kuntner et al. 2008).

We included polytomies when the available phylogeny was not completely resolved. Because branch length is unknown for most phylogenies we assigned all branches the same arbitrary value of one. Phylogenies were drawn using the PDTREE procedure within the statistical package PDAP (Garland et al. 1992) and then the phylogenetic distance matrix was imported into PHYLOGR. Fig. 2 shows the phylogeny of our sample of species.

To illustrate the results of those analysis that only involved one predictor variable we generated the independent contrasts (IC) following the method of Garland et al. (Garland et al. 1992) using the package PDAP (Garland et al. 1992), –the statistical package used here to run the GLS do not provide the possibility to draw scatter plots in which points are corrected for phylogenetic distances–. The Method of IC and the GLS are functionally identical (Garland & Ives 2000), although the former has lower statistical power when the phylogeny includes some polytomies (due to a decrease in the degrees of freedom). In addition, GLS has the advantage that it accommodates multiple independent variables. The results of the analyses following the IC methods are included in tables A2 and A5 of Supporting Information 1.

Because our sample size was very small for some species (See Table 1), we repeated the analysis excluding the four species that had only one individual for either sex. The results were qualitatively the same, with the p-values only marginally significant for some of the analyses due to the smaller sample size (see tables B1, B2, B3 of Supporting Information 3). Thus, our results are robust despite the relatively small sample size for some of the species used.

*Testing prediction i): SSD explains the differences in bridging propensity across taxa.* In order to assess the robustness of our results we applied two different approaches. First, we calculated the proportion of males and females that bridged for each species, and then we used these data to calculate a modified SDI index of bridging propensity ( $SDI_{bp}$ ). The modification was required because, in some species, the proportion of bridging females was equal to zero, and the SDI index is undefined when the minimal value (the denominator) is zero. To avoid dividing by zero we added one to the numerator and denominator of the quotient of the SDI index. We obtained the average values of CW for each sex and species, and then we calculated SDI using CW ( $SDI_{cw}$ ). Similarly we used the average mass for each sex and species to calculate mass SDI ( $SDI_{mass}$ ). We then ran two GLS analyses using  $SDI_{bp}$  as the dependent variable and either  $SDI_{cw}$  or  $SDI_{mass}$  as predictor variables. We predicted a negative relationship between differential bridging propensity and SSD. Note, that the prediction is a negative relationship between  $SDI_{bp}$  and  $SDI_{cw}$  or  $SDI_{mass}$  because SDIs are arbitrarily made negative when males are the larger sex. Thus, when the  $SDI_{cw}$  and  $SDI_{mass}$  are large and positive (large females), the  $SDI_{bp}$  is predicted to be large and negative (males bridge more than females). In the second approach we followed the method used by De Mas et al. (De Mas et al. 2009), which is an adaptation of Smith's suggestion for analyzing SSD through multiple regression using log-transformed variables and introducing statistical control (Smith 1999). As we did in the previous analysis, we introduced the average for each sex and species in the multiple regression model. Thus, we ran a GLS comparative analysis in which we included female bridging propensity as the dependent variable and female body size, male body size, and male bridging propensity as independent variables. All the variables were log-transformed using natural logarithms, although for bridging propensity we calculated the logarithm of one plus the proportion of bridging individuals (since, as mentioned above, bridging propensity included zeros). We predicted that female body size, statistically controlled in the model for male body size, would show a negative relationship with female bridging propensity, which was statistically controlled for male bridging propensity by including this variable on the right hand side of the model. As the prediction is for a negative relationship, all statistical tests were one-tailed. We used partial regression plots to graphically display the results of the multiple GLS analyses (Moya-Laraño & Corcobado 2008).

*Testing prediction ii): There is a negative relationship between body size and bridging propensity.* First, we tested whether body size (CW) or body mass explains the propensity to bridge separately for males and females. We then combined males and females in the same analysis and tested for an interaction between sex and body size. To perform this analysis we add at the tip of the main phylogeny an additional node with two branches, one for each sex (sex was coded as follows: males 0, females 1). For each sex we used the average of either CW or body mass as independent variables and the proportion of bridging individuals as the dependent variable. All the variables were log-transformed using the natural logarithm, but as above, for bridging propensity we added one to the raw value before log-transformation. Again, as the prediction is for a negative relationship, all statistical tests were one-tailed.

To calculate the threshold size above which spiders did not bridge we performed generalized linear models with binomial error and logit link functions using “size” (body mass or CW) as the predictor and occurrence or non- occurrence of bridging as the dependent variable. The predicted regression equations were then used to calculate the size beyond which the probability of bridging was very low (<0.05). To obtain confidence intervals for this threshold size, for each measure of size (body mass or CW), we generated 1000 logistic equations by randomly generating the equation parameters (slope and intercept). For each randomly generated equation, the values of the intercept and the slope were independent realizations of normally distributed random variables, with mean and standard deviation given by the expected value and standard error of the corresponding parameter in the original (data-driven) regression equation. The size (body mass or CW) for which the simulated logistic equation predicted a probability of bridging of 0.05 was stored for each of the 1000 runs, thus providing 1000 estimates of the threshold size. Eliminating the 2.5% highest and lowest values, we obtained the 95% confidence intervals for these parameters. Because we know of no method to include binomial errors in the evolutionary comparative method, this analysis did not include a correction for phylogenetic relatedness and treated individual spiders as independent data points. Although this analysis was not used for hypothesis testing, we realize that not correcting for phylogenetic relationships could substantially affect parameter estimation. However, a recent study using a very similar approach

(Moya-Laraño et al. 2009) showed that the calculation of optimal climbing speed in spiders changed very little regardless of whether phylogenetic correction was applied or not. Thus, here we assume that parameters would also change little (or at least not meaningfully) if we had applied a phylogenetic correction.

## **Acknowledgements**

We thank A. L. Llandres who helped to capture spiders and run trials in Extremadura, A. Moreno who helped to weigh spiders in the lab and E. Morano who determined the species *Tetragnatha nigrita* from Cabo de Gata (SE Spain). We also thank M. Foellmer and an anonymous reviewer who made valuable comments on an earlier version of this manuscript. This ms has been written under a pre-doctoral grant (FPI; ref: BES-2005-9234) from the Spanish Ministry of Science and Education (MEC)/FEDER to GC. This research has been partially funded by two MEC/FEDER grants (CGL2004-03153 and CGL2007-60520) to JM-L.



## References

- Abouheif,E. & Fairbairn,D.J. 1997. A comparative analysis of allometry for sexual size dimorphism: Assessing Rensch's rule. *American Naturalist* 149, 540-562.
- Agnarsson,I. 2004. Morphological phylogeny of cobweb spiders and their relatives (Araneae, Araneoidea, Theridiidae). *Zoological Journal of the Linnean Society* 141, 447-626.
- Aisenberg,A., Viera,C. & Costa,F.G. 2007. Daring females, devoted males, and reversed sexual size dimorphism in the sand-dwelling spider *Allocosa brasiliensis* (Araneae, Lycosidae). *Behavioral Ecology and Sociobiology* 62, 29-35.
- Alvarez-Padilla,F. 2007. Systematics of the spider genus *Metabus* O. P.-Cambridge, 1899 (Araneoidea : Tetragnathidae) with additions to the tetragnathid fauna of Chile and comments on the phylogeny of Tetragnathidae. *Zoological Journal of the Linnean Society* 151, 285-335.
- Anderson,J.T. & Morse,D.H. 2001. Pick-up lines: cues used by male crab spiders to find reproductive females. *Behavioral Ecology* 12, 360-366.
- Andersson,M. 1994. *Sexual Selection*. Princeton, NJ.: Princeton University Press.
- Arnedo,M.A., Coddington,J., Agnarsson,I. & Gillespie,R.G. 2004. From a comb to a tree: phylogenetic relationships of the comb-footed spiders (Araneae, Theridiidae) inferred from nuclear and mitochondrial genes. *Molecular Phylogenetics and Evolution* 31, 225-245.
- Benjamin,S.P., Dimitrov,D., Gillespie,R.G. & Hormiga,G. 2008. Family ties: molecular phylogeny of crab spiders (Araneae : Thomisidae). *Cladistics* 24, 708-722.
- Blackledge,T.A. & Hayashi,C.Y. 2006. Silken toolkits: biomechanics of silk fibers spun by the orb web spider *Argiope argentata* (Fabricius 1775). *Journal of Experimental Biology* 209, 2452-2461.
- Blackledge,T.A., Swindeman,J.E. & Hayashi,C.Y. 2005. Quasistatic and continuous dynamic characterization of the mechanical properties of silk from the cobweb of the black widow spider *Latrodectus hesperus*. *The journal of Experimental Biology* 208, 1937-1949.
- Blackledge,T.A. & Zevenbergen,J.M. 2007. Condition-dependent spider web architecture in the western black widow, *Latrodectus hesperus*. *Animal Behaviour* 73, 855-864.

- Blanckenhorn,W.U. 2000. The evolution of body size: What keeps organisms small? *Quarterly Review of Biology* 75, 385-407.
- Blanckenhorn,W.U. 2005. Behavioral causes and consequences of sexual size dimorphism. *Ethology* 111, 977-1016.
- Bonte,D. 2009. Inbreeding depresses short and long distance dispersal in three congeneric spiders. *Journal of Evolutionary Biology* 22, 1429-1434.
- Bonte,D., De Clercq,N., Zwertvaegher,I. & Lens,L. 2009. Repeatability of dispersal behaviour in a common dwarf spider: evidence for different mechanisms behind short- and long-distance dispersal. *Ecological Entomology* 34, 271-276.
- Brandt,Y. & Andrade,M.C.B. 2007a. Testing the gravity hypothesis of sexual size dimorphism: are small males faster climbers? *Functional Ecology* 21, 379-385.
- Brandt,Y. & Andrade,M.C.B. 2007b. What is the matter with the gravity hypothesis? *Functional Ecology* 21, 1182-1183.
- Coddington,J.A. 2005. Phylogeny and classification of spiders. In: *Spiders of North America: an Identification Manual American* (Ed. by D.Ubick, P.E.Cushing, P.E.Paquin & V.Roth), pp. 18-24. American Arachnological Society.
- Coddington,J.A., Hormiga,G. & Scharff,N. 1997. Giant female or dwarf male spiders? *Nature* 385, 687-688.
- Darwin,C. 1871. *The Descent of Man, and Selection in Relation to Sex*. London: John Murray.
- De Mas,E., Ribera,C. & Moya-Laraño,J. 2009. Resurrecting the differential mortality model of sexual size dimorphism. *Journal of Evolutionary Biology* 22, 1739-1749.
- Diaz-Uriarte,R. & Garland,T. PHYLOGR: Functions for phylogenetically based statistical analyses. Diaz-Uriarte,R. 2007. 3-3-2009.  
Ref Type: Electronic Citation
- Eberhard,W.G. 1987. How Spiders Initiate Airborne Lines. *Journal of Arachnology* 15, 1-9.
- Elgar,M.A. 1991. Sexual Cannibalism, Size Dimorphism, and Courtship Behavior in Orb-Weaving Spiders (Araneidae). *Evolution* 45, 444-448.
- Elgar,M.A. 1998. Sperm competition and sexual selection in spiders and other arachnids. In: *Sperm Competition and Sexual Selection* (Ed. by T.R.Birkhead & A.P.Möller), pp. 307-332. London, Academic Press.
- Fairbairn,D.J. 1997. Allometry for sexual size dimorphism: Pattern and process in the coevolution of body size in males and females. *Annual review of ecology and systematics* 28, 659-687.

- Fairbairn,D.J. 2007. Introduction: the enigma of sexual size dimorphism. In: *Sex, Size & Gender Roles: Evolutionary Studies of Sexual Size Dimorphism*, pp. 1-10. New York, Oxford University Press.
- Fairbairn,D.J., Blanckenhorn,W.U. & Székely,T. 2007. *Sex, Size & Gender Roles: Evolutionary Studies of Sexual Size Dimorphism*. New York: Oxford University Press.
- Foelix,R.F. 1996. *Biology of Spiders*. 2<sup>nd</sup> edn. Oxford: Oxford University Press.
- Foellmer,M.W. & Moya-Laraño,J. 2007. Sexual Size Dimorphism in Spiders. In: *Sex, Size & Gender Roles. Evolutionary Studies of Sexual Size Dimorphism* (Ed. by D.J.Fairbairn, W.U.Blanckenhorn & T.Szekely), pp. 71-81. New York, Oxford University Press.
- Garland,T.Jr., Harvey,P.H. & Ives,A.R. 1992. Procedures for the Analysis of Comparative Data Using Phylogenetically Independent Contrasts. *Systematic Biology* 41, 18-32.
- Garland,T.Jr. & Ives,A.R. 2000. Using the past to predict the present: Confidence intervals for regression equations in phylogenetic comparative methods. *American Naturalist* 155, 346-364.
- Garrido,M.A., Elices,M., Viney,C. & Perez-Rigueiro,J. 2002. Active control of spider silk strength: comparison of drag line spun on vertical and horizontal surfaces. *Polymer* 43, 1537-1540.
- Ghiselin,M. 1974. *The Economy of Nature and the Evolution of Sex*. Berkeley: University of California Press.
- Grafen,A. 1989. The Phylogenetic Regression. *Philosophical Transactions of the Royal Society of London Series B-Biological Sciences* 326, 119-157.
- Hayashi,C.Y., Blackledge,T.A. & Lewis,R.V. 2004. Molecular and mechanical characterization of aciniform silk: Uniformity of iterated sequence modules in a novel member of the spider silk fibroin gene family. *Molecular Biology and Evolution* 21, 1950-1959.
- Head,G. 1995. Selection on Fecundity and Variation in the Degree of Sexual Size Dimorphism Among Spider Species (Class Araneae). *Evolution* 49, 776-781.
- Hormiga,G., Scharff,N. & Coddington,J.A. 2000. The phylogenetic basis of sexual size dimorphism in orb-weaving spiders (Araneae, Orbiculariae). *Systematic Biology* 49, 435-462.
- Huxley,J.S. 1938. Darwin's theory of sexual selection and the data subsumed by it, in the light of recent research. *American Naturalist* 72, 416-433.
- Kuntner,M., Coddington,J.A. & Hormiga,G. 2008. Phylogeny of extant nephilid orb-weaving spiders (Araneae, Nephilidae): testing morphological and ethological homologies. *Cladistics* 24, 147-217.

- Lande,R. 1980. Sexual Dimorphism, Sexual Selection, and Adaptation in Polygenic Characters. *Evolution* 34, 292-305.
- Legrand,R.S. & Morse,D.H. 2000. Factors driving extreme sexual size dimorphism of a sit-and-wait predator under low density. *Biological Journal of the Linnean Society* 71, 643-664.
- Linn,C.D. 2001. The Effect of Male Size on Travel Ability in the Colden Orb-Weaving Spider *Nephila Clavipes*: Implications for Sexual Size Dimorphism. Department of Psychology. Tulane University.
- Lovich,J.E. & Gibbons,J.W. 1992. A Review of Techniques for Quantifying Sexual Size Dimorphism. *Growth Development and Aging* 56, 269-281.
- Lubin,Y., Ellner,S. & Kotzman,M. 1993. Web Relocation and Habitat Selection in A Desert Widow Spider. *Ecology* 74, 1915-1928.
- Madsen,B., Shao,Z.Z. & Vollrath,F. 1999. Variability in the mechanical properties of spider silks on three levels: interspecific, intraspecific and intraindividual. *International Journal of Biological Macromolecules* 24, 301-306.
- Main,B.Y. 1990. Dwarf males in mygalomorph spiders: adaptation to environmental hazards. *Acta Zoologica Fennica* 190, 273-278.
- Miller,J.A. & Hormiga,G. 2004. The unbearable lightness of being monophyletic: Clade stability and the addition of data: A case study from erigonine spiders (Araneae : Linyphiidae, Erigoninae). *Cladistics-the International Journal of the Willi Hennig Society* 20, 89.
- Moore,C.W. 1977. Life-Cycle, Habitat and Variation in Selected Web Parameters in Spider, *Nephila-Clavipes* Koch (Araneidae). *American Midland Naturalist* 98, 95-108.
- Morse,D.H. & Fritz,R.S. 1982. Experimental and Observational Studies of Patch Choice at Different Scales by the Crab Spider *Misumena-Vatia*. *Ecology* 63, 172-182.
- Moya-Laraño,J., Vinkovic,D., Allard,C.M. & Foellmer,M.W. 2009. Optimal climbing speed explains the evolution of extreme sexual size dimorphism in spiders. *J. Evol. Biol.* 22, 954-963.
- Moya-Laraño,J. & Corcobado,G. 2008. Plotting partial correlation and regression in ecological studies. *Web Ecology* 8, 35-46.
- Moya-Laraño,J., Halaj,J. & Wise,D.H. 2002. Climbing to reach females: Romeo should be small. *Evolution* 56, 420-425.
- Moya-Laraño,J., Vinkovic,D., Allard,C.M. & Foellmer,M.W. 2007a. Mass-mediated sex differences in climbing patterns support the gravity hypothesis of sexual size dimorphism. *Web Ecology* 7, 106-112.

- Moya-Laraño,J., Vinkovic,D., De Mass,E., Corcobado,G. & Moreno,E. 2008. Morphological Evolution of Spiders Predicted by Pendulum Mechanics. *PLoS ONE* 3.
- Moya-Laraño,J., Vinkovic,D., Allard,C. & Foellmer,M. 2007b. Gravity still matters. *Functional Ecology* 21, 1178-1181.
- Peters,H.M. 1990. On the structure and glandular origin of bridging lines used by spiders for moving to distant places. *Acta Zoologica Fennica* 190, 309-314.
- Peters,H.M. & Kovoov,J. 1991. The Silk-Producing System of Linyphia-Triangularis (Araneae, Linyphiidae) and Some Comparisons with Araneidae - Structure, Histochemistry and Function. *Zoomorphology* 111, 1-17.
- Prenter,J., Elwood,R.W. & Montgomery,W.I. 1999. Sexual size dimorphism and reproductive investment by female spiders: A comparative analysis. *Evolution* 53, 1987-1994.
- Prenter,J., Elwood,R.W. & Montgomery,W.I. 2003. Mate guarding, competition and variation in size in male orb-web spiders, *Metellina segmentata*: a field experiment. *Animal Behaviour* 66, 1053-1058.
- Prenter,J., Montgomery,W.I. & Elwood,R.W. 1995. Multivariate Morphometrics and Sexual Dimorphism in the Orb-Web Spider *Metellina-Segmentata* (Clerck, 1757) (Araneae, Metidae). *Biological Journal of the Linnean Society* 55, 345-354.
- Prenter,J., Perez-Staples,D. & Taylor,P.W. 2010. The effects of morphology and substrate diameter on climbing and locomotor performance in male spiders. *Functional Ecology* 24, 400-408.
- Ramos,M.M., Irschick,D. & Christenson,T. 2004. Overcoming an evolutionary conflict: Removal of a reproductive organ greatly increases locomotor performance. *PNAS* 101 , 4883-4887.
- Roberts,M.J. 1995. *Spiders of Britain and Northern Europe*. London: Harpen Collins.
- Rodriguez-Girones,M.A., Corcobado,G. & Moya-Laraño,J. 2010. Silk elasticity as a potential constraint on spider body size. *Journal of Theoretical Biology* 266, 430-435.
- Roff,D.A. 2002. *Life Hystory Evolution*. Sunderland, MA: Sinauer Associates.
- Roff,D.A. & Fairbairn,D.J. 2007. The evolution of trade-offs: where are we? *Journal of Evolutionary Biology* 20, 433-447.
- Schneider,J.M., Herberstein,M.E., De Crespigny,F.C., Ramamurthy,S. & Elgar,M.A. 2000. Sperm competition and small size advantage for males of the golden orb-web spider *Nephila edulis*. *Journal of Evolutionary Biology* 13, 939-946.

- Smith,R.J. 1999. Statistics of sexual size dimorphism. *Journal of Human Evolution* 36, 423-458.
- Tso,I.M., Chiang,S.Y. & Blackledge,T.A. 2007. Does the giant wood spider *Nephila pilipes* respond to prey variation by altering web or silk properties? *Ethology* 113, 324-333.
- Vollrath,F. 1999. Biology of spider silk. *International Journal of Biological Macromolecules* 24, 81-88.
- Vollrath,F. & Kohler,T. 1996. Mechanics of silk produced by loaded spiders. *Proceedings of the Royal Society of London Series B-Biological Sciences* 263, 387-391.
- Vollrath,F., Madsen,B. & Shao,Z.Z. 2001. The effect of spinning conditions on the mechanics of a spider's dragline silk. *Proceedings of the Royal Society of London Series B-Biological Sciences* 268, 2339-2346.
- Vollrath,F. & Parker,G.A. 1992. Sexual Dimorphism and Distorted Sex-Ratios in Spiders. *Nature* 360, 156-159.

## Supporting Information

### **Supporting Information 1: *Extended statistics tables.***

Description: This file includes tables A1-A6 with additional statistical information related to the analyses included in the manuscript.

### **Supporting Information 2: *Plots of raw data.***

Description: This file includes scatterplots of raw data (points are not controlled for phylogenetic distance). Fig. A1 shows the relationship between SSD and sex differences in bridging propensity; Fig. A2 shows the relationship between body size and bridging propensity.

### **Supporting Information 3: *Additional statistics tables.***

Description: This file includes tables B1-B3 with additional statistical information related to the main analyses included in the manuscript, but in which we excluded the 4 species which had only one individual in either sex. Thus, here analyses include only 9 species.

## Supporting Information 1

**Table A1:** Univariate Generalized Least Squares (GLS) comparative analyses using SDI bridging propensity ( $SDI_{bp}$ ) as the dependent variable, and SDI mass or SDI carapace width ( $SDI_{cw}$ ) as independent variables respectively. Bold letters show significant results.

<b>GLS: Dependent variable <math>SDI_{bp}</math></b>					
<b>Variable</b>	<b>Estimate</b>	<b>SE</b>	<b>t-value</b>	<b>df</b>	<b>P*</b>
<b>SDI mass</b>	<b>-0.0137</b>	<b>0.0056</b>	<b>-2.440</b>	<b>11</b>	<b>0.0164</b>
<b>SDI cw</b>	<b>-0.4837</b>	<b>0.1468</b>	<b>-3.296</b>	<b>11</b>	<b>0.0036</b>

\*Test is one-tailed

**Table A2:** Comparative analyses based on the Independent Contrast method, using SDI bridging propensity ( $SDI_{bp}$ ) as the dependent variable, and SDI mass or SDI carapace width ( $SDI_{cw}$ ) as independent variables respectively. Bold letters show significant results.

<b>IC: Dependent variable <math>SDI_{bp}</math></b>					
<b>Variable</b>	<b>Estimate</b>	<b>SE</b>	<b>t-value</b>	<b>df</b>	<b>P*</b>
<b>SDI mass</b>	<b>-0.0144</b>	<b>0.0054</b>	<b>-2.6345</b>	<b>8</b>	<b>0.0150</b>
<b>SDI cw</b>	<b>-0.4767</b>	<b>0.1455</b>	<b>-3.2753</b>	<b>8</b>	<b>0.0113</b>

\*Test is one-tailed

**Table A3:** Multivariate Generalized Least Squares (GLS) comparative analyses including female bridging propensity (FPB): number of bridging females divided by to the total of females for each species, as the dependent variable. As predicting variables the first model includes female body mass (FMASS); male body mass (MMASS), male bridging propensity (MPB): number of bridging males of each species divided by the total number of males used for that species. In the second model the variables related to SSD are female carapace width (FCW) and male carapace width (MCW). All variables were ln-transformed (see text for more details). Bold letters show significant results relevant to the “Bridging GH”.

<b>GLS: Dependent variable FBP</b>						
	<b>Independent Variable</b>	<b>Estimate</b>	<b>SE</b>	<b>t-value</b>	<b>df</b>	<b>p*</b>
Mass	<b>FMASS</b>	<b>-0.1942</b>	<b>0.0535</b>	<b>-3.631</b>	<b>9</b>	<b>0.0027</b>
	MMASS	0.0873	0.1068	0.818	9	0.2173
	MBP	-1.6545	1.6970	-0.975	9	0.1775
Carapace Width	<b>FCW</b>	<b>-0.5532</b>	<b>0.1809</b>	<b>-3.059</b>	<b>9</b>	<b>0.0068</b>
	MCW	0.0147	0.4045	0.036	9	0.4859
	MBP	-2.4281	1.8957	-1.281	9	0.1162

\*Test is one-tailed

**Table A4:** Univariate Generalized Least Squares (GLS) comparative analyses using bridging propensity as the dependent variable and body size as the independent variable. Analyses were run for males and females separately. a) Univariate regressions including either female body mass (FMASS) or female carapace width (FCW) predicting female bridging propensity (FBP). b) Univariate regressions including either male body mass (MMASS) or male carapace width (MCW) predicting male bridging propensity (MBP). All variables were ln-transformed (see text for more details). Bold letters show significant results.

<b>Table 3a) GLS: Dependent variable FBP</b>					
<b>Variable</b>	<b>Estimate</b>	<b>SE</b>	<b>t-value</b>	<b>df</b>	<b>P*</b>
<b>FMASS</b>	<b>-0.1432</b>	<b>0.0301</b>	<b>-4.751</b>	<b>11</b>	<b>0.0003</b>
<b>FCW</b>	<b>-0.4631</b>	<b>0.1023</b>	<b>-4.528</b>	<b>11</b>	<b>0.0004</b>
<b>Table 3b) GLS: Dependent variable MBP</b>					
<b>Variable</b>	<b>Estimate</b>	<b>SE</b>	<b>t-value</b>	<b>df</b>	<b>P*</b>
MMASS	-0.0184	0.0110	-1.668	11	0.0615
<b>MCW</b>	<b>-0.0826</b>	<b>0.0352</b>	<b>-2.350</b>	<b>11</b>	<b>0.0192</b>

\*Test is one-tailed



**Table A5:** Comparative analyses based on the Independent Contrasts method using bridging propensity as the dependent variable and body size as the independent variable. Analyses were run for males and females separately. a) Univariate regressions including either female body mass (FMASS) or female carapace width (FCW) predicting female bridging propensity (FBP). b) Univariate regressions including either male body mass (MMASS) or male carapace width (MCW) predicting male bridging propensity (MBP). All variables were ln-transformed (see text for more details). Bold letters show significant results.

<b>Table A5a) IC: Dependent variable FBP</b>					
<b>Variable</b>	<b>Estimate</b>	<b>SE</b>	<b>t-value</b>	<b>df</b>	<b>P*</b>
<b>FMASS</b>	<b>-0.1470</b>	<b>0.0351</b>	<b>-4.1805</b>	<b>8</b>	<b>0.0015</b>
<b>FCW</b>	<b>-0.4610</b>	<b>0.1166</b>	<b>-3.9546</b>	<b>8</b>	<b>0.0021</b>

<b>Table A5b) IC: Dependent variable MBP</b>					
<b>Variable</b>	<b>Estimate</b>	<b>SE</b>	<b>t-value</b>	<b>df</b>	<b>P*</b>
MMASS	-0.0170	0.0147	-1.1601	8	0.1397
<b>MCW</b>	<b>-0.0984</b>	<b>0.0501</b>	<b>-1.9642</b>	<b>8</b>	<b>0.0425</b>

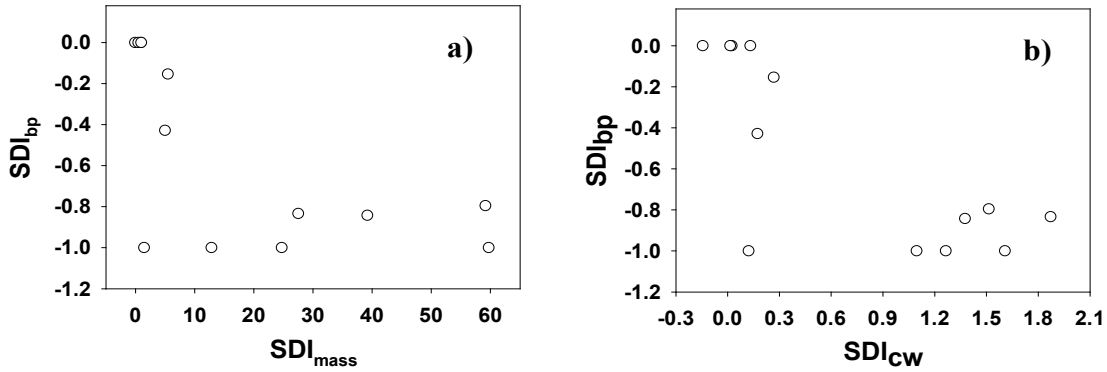
\*Test is one-tailed

**Table A6:** Multivariate Generalized Least Squares (GLS) comparative analyses combining both sexes in the same analysis. The dependent variable was bridging propensity (PB): number of bridging individuals of each sex divided by to the total of individuals of that sex for each species. As predicting variables the first model includes body mass (MASS); SEX and the interaction between SEX and MASS. In the second model we use carapace width (CW) instead of mass to measure body size. All variables (except sex) were ln-transformed (see text for more details). Bold letters show significant results.

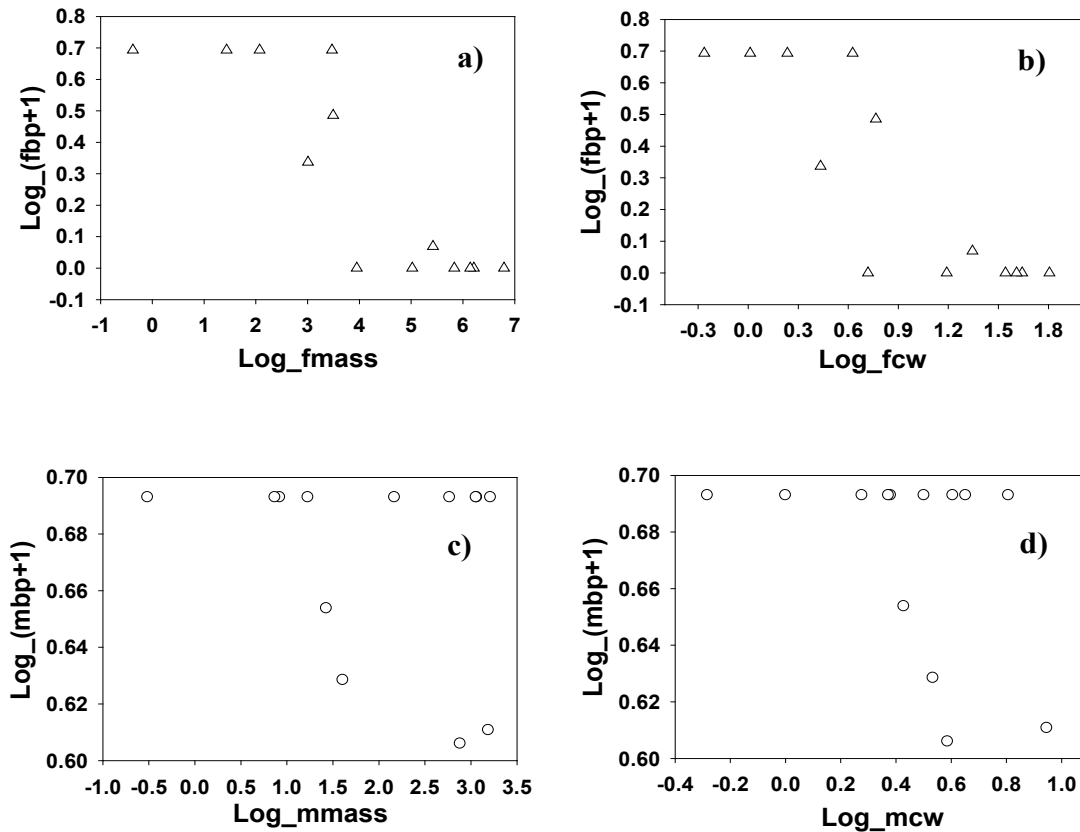
<b>GLS: Dependent variable FBP</b>						
	<b>Independent Variable</b>	<b>Estimate</b>	<b>SE</b>	<b>t-value</b>	<b>df</b>	<b>p*</b>
Mass	MASS	-0.0420	0.0368	-1.143	22	0.1327
	SEX	0.1034	0.0874	1.184	22	0.1245
	<b>SEX * MASS</b>	<b>-0.0987</b>	<b>0.0319</b>	<b>-3.093</b>	<b>22</b>	<b>0.0027</b>
Carapace Width	CW	-0.1353	0.14931	-0.907	22	0.1872
	SEX	-0.05782	0.06977	-0.829	22	0.2081
	<b>SEX * CW</b>	<b>-0.30148</b>	<b>0.11982</b>	<b>-2.516</b>	<b>22</b>	<b>0.0197</b>

\*Test is one-tailed

## Supporting Information 2



**Figure A1: Difference in bridging propensity between sex ( $SDI_{bp}$ ) vs. SSD ( $SDI_{SSD}$ ).** SSD was measured either using body mass (a) or carapace width (b) using the SDI index. Also an SDI index was calculated for difference in bridging propensity between sexes. Plots show the relationship of SSD (Fig A1a,  $SDI_{mass}$ ; Fig A1b,  $SDI_{cw}$ ) and difference in bridging propensity ( $SDI_{bp}$ ). Points are raw data without controlling for the phylogeny (n=13).



**Figure A2: Bridging propensity vs. body size.** Plots showing the relationship between body size, measured either as mass (a, c) or as carapace width (cw) (b, d), and bridging propensity (bp). Females (a,b), Males (c,d). All the variables were log-transformed, and in the case of bridging propensity, since the data included 0, we add 1 before log-transformation. Points are raw data without controlling for the phylogeny (n=13)

### Supporting Information 3

**Table B1:** Univariate Generalized Least Squares (GLS) comparative analyses using SDI bridging propensity ( $SDI_{bp}$ ) as the dependent variable, and SDI mass or SDI carapace width ( $SDI_{cw}$ ) as independent variables respectively. Only 9 species included (those with more than 1 individual of each sex). Bold letters show significant results.

<b>GLS: Dependent variable <math>SDI_{bp}</math></b>					
<b>Variable</b>	<b>Estimate</b>	<b>SE</b>	<b>t-value</b>	<b>df</b>	<b>P*</b>
<b>SDI mass</b>	<b>-0.0147</b>	<b>0.0070</b>	<b>-2.085</b>	<b>7</b>	<b>0.0378</b>
<b>SDI cw</b>	<b>-0.4503</b>	<b>0.1685</b>	<b>-2.672</b>	<b>7</b>	<b>0.0160</b>

\*Test is one-tailed

**Table B2:** Multivariate Generalized Least Squares (GLS) comparative analyses including as the dependent variable female bridging propensity (FBP): for each species, the number of bridging females divided by the total number of females tested. As predictor variables the first model includes female body mass (FMASS); male body mass (MMASS) and male bridging propensity (MPB): number of bridging males of each species divided by the total number of males tested for that species. In the second model the variables related to SSD are female carapace width (FCW) and male carapace width (MCW). All variables were ln-transformed (see text for more details). Only 9 species were included (those with more than 1 individual for each sex). Bold letters show significant results relevant to the “Bridging GH”.

<b>GLS: Dependent variable FBP</b>						
	<b>Independent Variable</b>	<b>Estimate</b>	<b>SE</b>	<b>t-value</b>	<b>df</b>	<b>p*</b>
Mass	<b>FMASS</b>	<b>0.1854</b>	<b>0.0960</b>	<b>-1.931</b>	<b>7</b>	<b>0.0555</b>
	MMASS	0.0924	0.1692	0.546	7	0.3040
	MBP	-1.2838	2.8769	-0.446	7	0.337
Carapace Width	<b>FCW</b>	<b>-0.5354</b>	<b>0.2933</b>	<b>-1.826</b>	<b>7</b>	<b>0.0635</b>
	MCW	0.0985	0.5890	0.167	7	0.4370
	MBP	-1.9127	3.0768	-0.622	7	0.2805

\*Test is one-tailed

**Table B3:** Univariate Generalized Least Squares (GLS) comparative analyses using bridging propensity as the dependent variable and body size as the independent variable. Analyses were run for males and females separately. a) Univariate regressions including either female body mass (FMASS) or female carapace width (FCW) predicting female bridging propensity (FBP). b) Univariate regressions including either male body mass (MMASS) or male carapace width (MCW) predicting male bridging propensity (MBP). All variables were ln-transformed (see text for more details). Only 9 species were included (those with more than 1 individual for each sex). Bold letters show significant results.

**Table B3a) GLS: Dependent variable FBP**

<b>Variable</b>	<b>Estimate</b>	<b>SE</b>	<b>t-value</b>	<b>df</b>	<b>P*</b>
<b>FMASS</b>	<b>-0.1288</b>	<b>0.0355</b>	<b>-3.630</b>	<b>7</b>	<b>0.0042</b>
<b>FCW</b>	<b>-0.4183</b>	<b>0.1163</b>	<b>-3.597</b>	<b>7</b>	<b>0.0044</b>

**Table B3b) GLS: Dependent variable MBP**

<b>Variable</b>	<b>Estimate</b>	<b>SE</b>	<b>t-value</b>	<b>df</b>	<b>P*</b>
MMASS	-0.0179	0.0114	-1.573	7	0.0800
<b>MCW</b>	<b>-0.0788</b>	<b>0.0368</b>	<b>-2.14</b>	<b>7</b>	<b>0.0348</b>

\*Test is one-tailed

# MANUSCRIPT IV

## Sociality level explains dispersal ability in spiders

Guadalupe Corcobado<sup>1\*</sup>, Miguel A. Rodríguez-Gironés<sup>1</sup>, Jordi Moya-Laraño<sup>1</sup>,  
Leticia Avilés<sup>2</sup>

<sup>1</sup>Dpto. de Ecología Funcional y Evolutiva, Estación Experimental de Zonas Áridas, CSIC, Carretera de Sacramento, s/n. La Cañada de San Urbano, C.P. 04120. Almería, Spain.

<sup>2</sup>Biodiversity Research Centre. Department of Zoology. University of British Columbia. 6270 University Blvd. Vancouver, BC V6T 1Z4. Canada.



## Resumen

1. Los costes y los beneficios de la dispersión pueden variar bajo diferentes condiciones ambientales. Una de estas condiciones ecológicas es la sociabilidad, la cual una vez establecida podría modular la habilidad para dispersarse. Las arañas sociales constituyen un excelente sistema para estudiar el link entre sociabilidad y comportamiento dispersivo dado que puede encontrarse un amplio rango de niveles de sociabilidad entre especies de un mismo género.
2. Hasta ahora la investigación centrada en estudiar la relación entre dispersión y sociabilidad se ha basado en aproximaciones indirectas tales como el estudio de clases de edad, la estructura genética poblacional o estudios observacionales de campo. En este trabajo, por primera vez, se estudió la relación entre dispersión y sociabilidad siguiendo una aproximación mecanística y funcional.
3. Con el objetivo de testar si una progresiva reducción en la habilidad para dispersarse ha acompañado la evolución de la sociabilidad, se realizaron carreras experimentales para medir la propensidad y la habilidad para puentear –un modo de locomoción aérea muy común en arañas que probablemente tenga especial relevancia en la dispersión pre-apareamiento– en siete especies de *Anelosimus* (Theridiidae) con diferente grado de sociabilidad.
4. Se encontró que la tendencia a dispersarse mediante puenteo y, al menos en macho, la habilidad para dispersarse, disminuía significativamente a medida que el nivel de sociabilidad se intensificaba. Además, se detectó una reducción en la longitud relativa de la pata –i.e. relativa al tamaño corporal– a medida que aumentaba la sociabilidad y disminuía la capacidad para puentear en machos, lo cual podría estar mecanísticamente relacionado con una pérdida de habilidad para puentear
5. Se encontró que la pérdida tanto en la propensidad como en la capacidad para dispersarse mediante puenteo es progresiva a lo largo del gradiente sociabilidad sin la existencia de un umbral pronunciado entre las tradicionalmente consideradas como especies subsociales y sociales. Este resultado está de acuerdo con la idea de que la sociabilidad, en lugar de ser un rasgo categórico (social vs subsocial), es una variable continua que agrupa a una amplia lista de características de la historia de vida.
6. Dado que la sociabilidad en arañas es un rasgo derivado, proponemos que la las limitaciones para dispersarse que siguen a la evolución de la sociabilidad podrían incrementar significativamente los costes de la dispersión y, por consiguiente, contribuir al mantenimiento de la sociabilidad una vez que se ha alcanzado.

**Palabras clave:** *Anelosimus*, arañas sociales, arañas subsociales, evolución de la sociabilidad, puenteo.

## Abstract

1. The costs and benefits of dispersal may vary under different ecological conditions. One such ecological condition is sociality, which once established could shape dispersal abilities. Spiders constitute an excellent system to study the link between sociality and dispersal behaviour because a broad range of sociality levels can be found among the species of a single genus.
2. Until now research on the link between dispersal and sociality has been based on indirect approaches such as the study of age classes, population genetic structure or observational field studies. Here, we study the link between dispersal and sociality following a functional and mechanistic approach for the first time.
3. In order to test if a progressive reduction of the ability to disperse has accompanied the evolution of sociality we performed experimental trials to measure the propensity and ability to bridge – a common aerial locomotion mode in spiders which probably has special relevance during pre-mating dispersal – in seven species of *Anelosimus* (Theridiidae) with different degrees of sociality.
4. We found that the tendency to disperse by bridging, and, at least in males, the ability to disperse, significantly decreases as the level of sociality increases. Additionally, we detected a reduction of leg length relative to body size with increasing sociality and decreasing dispersal abilities in males, which may be mechanistically related to a reduced ability to bridge.
5. We found that the tendency and ability to disperse by bridging decrease gradually across the sociality gradient without a pronounced threshold between the traditionally considered subsocial and social species. This result agrees with the idea that sociality in spiders, instead of being a discretely categorical trait (social vs subsocial), is a continuous variable that groups together a broad list of life-history traits.
6. Since sociality in spiders is a derived character, we propose that these dispersal constraints associated with the evolution of sociality could significantly increase the cost of dispersal, and subsequently contribute to the maintenance of sociality once it is achieved.

**Keywords:** *Anelosimus*, bridging, evolution of sociality, social spiders, subsocial spiders.

## Introduction

Dispersal is an important trait in the life history of organisms (Johnson & Gaines 1990; Clobert et al. 2001). Dispersal contributes to the maintenance of genetic variability and the colonization of new potential habitats, decreases inbreeding, intra-sexual mate competition or resource competition and also affects metapopulation dynamics. However, dispersal has some important costs associated to the risk of predation and the probability of survival during dispersal. Thus, the pattern of dispersal that maximizing the expected fitness depends on the ecological conditions than an individual experiences (reviewed in Johnson & Gaines 1990).

Social spiders constitute an excellent system to study dispersal because of the association of this trait with different social and breeding systems (Bilde et al. 2005; Aviles & Bukowski 2006; Bilde et al. 2007). Indirect evidence suggest that the costs associated to dispersal could exceed the potential benefits in the case of the more social spiders, while in less social species (i.e. subsocial spiders) the possible benefits achieved from dispersal could make it still worthy for offspring to leave the parental nest. The more developed social spiders –non-territorial permanent-social, according to the classification of Aviles (Aviles 1997)– are characterized by a lack of a generalized pre-mating dispersal phase. Members of both sexes remain within their natal nest to mate generation after generation, resulting in a high level of inbreeding. It is expected that a long history of inbreeding in these species would have purged most of the load of deleterious recessive alleles (Charlesworth & Charlesworth 1987; Bilde et al. 2005). Social spiders also exhibit highly female-biased sex ratios and a population structure where within a population neighboring colonies are genetically very similar (Johannesen et al. 2002; Johannesen et al. 2009b; Agnarsson et al. 2010). All these factors should decrease the potential benefits of dispersal for social spiders, while its costs are likely high because in environments where social species live single females have little success founding new colonies (Vollrath 1982; Bilde et al. 2007). Consequently, in social spiders the balance between costs and benefits of dispersal should be biased against dispersal compared to subsocial or solitary



species (Aviles 1997; Henschel 1998; Bilde et al. 2005; Aviles & Bukowski 2006; Bilde et al. 2007; Johannesen et al. 2009a). Field observations show that, in these social spiders there is limited male dispersal (Lubin et al. 2009) and new colony foundation is mainly carried out by groups of already mated females that disperse when the colony reaches a very large size (Vollrath 1982; Lubin & Robinson 1982; Schneider et al. 2001). The group of spiders, generally referred to as subsocial –non-territorial-periodic-social, according to the classification of Aviles (Aviles 1997)–, show an intermediate degree of sociality. In these species the maternal care phase is extended and juveniles live together in the natal nest after the mother dies. Subsocial spiders are characterized by a pre-mating dispersal phase and a typically outbred system (e.g. Aviles 1997; Lubin & Bilde 2007). Because the sex ratios are not biased, males may face stronger mate competition. Molecular studies have shown that within a population there is considerable genetic variability among neighboring colonies, compared to social species (Johannesen et al. 1998; Johannesen & Lubin 1999; Johannesen & Lubin 2001; Johannesen et al. 2002; Johannesen et al. 2009b; Agnarsson et al. 2010). Such genetic variability probably reflects mixing due mostly to breeding dispersal (e.g. Klein et al. 2005; Bilde et al. 2005; Ruch et al. 2009), as field studies have shown that natal dispersal distances in subsocial species are mostly short (Aviles & Gelsey 1998; Lubin et al. 1998; Powers & Aviles 2003; Li & Kuan 2006). While resource competition is probably the main selective pressure driving natal dispersal (Aviles & Gelsey 1998; Powers & Aviles 2003), mate competition and inbreeding avoidance are likely drivers of breeding dispersal (Li & Kuan 2006). At this point it is interesting to highlight that all the studies mentioned above show indirect evidence of a scarce role of pre-mating dispersal in social compared to subsocial spiders based on data of the evaluation of age classes, sex ratio, population genetic structure or some observational field data using mark-recapture techniques. In contrast, until now, no previous studies have focused on dispersal from a mechanistic and functional point of view by experimentally measuring the ability to disperse across a sociality gradient and trying to uncover the mechanisms involved in a possible reduction in the ability to disperse in the more social species.

Even though sociality is a rare phenomenon in spiders –about 0.06% of species exhibit it, according to Aviles et al. (Aviles et al. 2007)– it has evolved

repeatedly and independently in several taxonomic groups (Agnarsson 2006; Agnarsson et al. 2006a; Johannesen et al. 2007). Social behavior appears to be a derived character, evolved from subsocial-like ancestors, which in turn would be derived from solitary species with extended maternal care (Aviles 1997; Johannesen et al. 1998; Agnarsson et al. 2006a; Lubin & Bilde 2007; but see Agnarsson et al. 2006b). An important step in the evolution of sociality is the loss of the pre-mating dispersal phase in subsocial species. Consequently, analyzing the factors that lead to dispersal in subsocial spiders, but limit dispersal in social ones, can help us to understand how this transition took place (Johannesen & Lubin 2001; Powers & Aviles 2003; Li & Kuan 2006).

Our goal in this study is to test the hypothesis that a progressive loss of the ability to disperse has accompanied the evolution of sociality in spiders, focusing either on the loss of the function (i.e., the ability to disperse) and on the mechanisms involved (i.e., spider shape related to dispersal). We test this hypothesis across species of the genus *Anelosimus* with different degrees of sociality. This genus has become a model system to study sociality because it includes 8 out of the 23 known social spider species and 6 out of 18 independent origins of sociality identified across spiders (Aviles 1997; Agnarsson 2006; Agnarsson et al. 2006a; Lubin & Bilde 2007; Agnarsson et al. 2007).

*Anelosimus* species live in high vegetation where dispersal using silk is typical. Of the two modes of dispersal in spiders, ballooning, used for long distance displacements, and bridging, for more localized dispersal (several meters) (Bonte et al. 2009) we focus on the latter because bridging is the mode used by subsocial (Ward & Lubin 1993; Aviles & Gelsey 1998; Powers & Aviles 2003; Li & Kuan 2006) and social (Lubin et al. 2009) spiders to establish new nests and in breeding dispersal (Klein et al. 2005; Lubin et al. 2009). In order to bridge a spider produces a thread of silk that is pulled by the wind until it attaches to a nearby plant. After tensing the line the spider crosses the line bridge hanging upside-down from the silk (Peters 1990). We can expect selection to favour the evolution of body shapes and sizes adapted to dispersal in those species where dispersal plays an important role. In particular, selection for efficient bridging leads to leg elongation (Moya-Laraño et

al. 2008). Species from the genus *Anelosimus* have been shown to be efficient bridgers (Moya-Laraño et al. 2008).

Sex biased dispersal is quite common and covaries with the mating system. In general, male-biased dispersal is expected in polygynous mating systems (Perrin & Mazalov 2000). In solitary spiders, males usually mate with several females and, as a consequence, males are generally the searching (Foelix 1996; but see Aisenberg et al. 2007). Very little is known about sex-biased dispersal in social spiders. While different studies have found different patterns in subsocial species (Aviles & Gelsey 1998; Johannesen & Lubin 2001; Powers & Aviles 2003; Li & Kuan 2006; Ruch et al. 2009), in social species females are believed to be responsible for colony foundation (Vollrath 1982; Lubin & Robinson 1982; Schneider et al. 2001; Johannesen et al. 2002; Johannesen et al. 2009b) and limited male dispersal has been found (Lubin et al. 2009).

Here we set out to test four specific predictions of the hypothesis of a progressive loss of dispersal ability with increasing level of sociality in spiders. Since mating in social species takes place inside the maternal nest, we predict that as the degree of sociality increases, spiders should have (i) decreased their propensity to disperse by bridging and (ii) become less efficient bridgers. The above two predictions refer to a behavioural trait (propensity) and the measurement of the ability to bridge (performance) respectively. Furthermore, because social spiders experience a reduced selective pressure for efficient bridging, we predict that (iii) the more social species should have relatively shorter legs in relation to their body size, thus being this progressive decrease of the relative leg length the mechanism responsible for the loss of dispersal (Moya-Laraño et al. 2008 *manuscript I of this thesis*), with this effect being (iv) stronger in males, as in spiders males are, for the most part, the searching sex.

To test these predictions we performed experimental bridging trials in the laboratory using adult males and females of seven species of the genus *Anelosimus* that exhibit different degrees of sociality and analyzed the data correcting for the non-independence due to common ancestry of species (Grafen 1989). As far as we know the approach of looking experimentally at dispersal ability following a

functional and mechanistic approach to understand the evolution and maintenance of sociality has not been considered so far in studies of sociality.

## Material and Methods

### Bridging trials

We collected males and females of seven different species of the genus *Anelosimus* (Theridiidae) in the provinces of Napo and Pichincha, in Ecuador (Figs 1 and 2; see SI table S1 and S2 for details). Our sample included four social and three subsocial species following the classification by Aviles (Aviles 1997) and Lubin & Bilde (Lubin & Bilde 2007). We did not include any solitary species, because all species of the genus *Anelosimus* found hitherto in Ecuador are either social or subsocial (Agnarsson et al. 2006b). We kept spiders in jars until testing, which always occurred within 48 hours of collection. Trials were performed in local makeshift laboratories and always at room temperature (range = 13.7 – 24.1 °C; Mean = 20.07, SD = 2.46).



**Figure 1:** Group of individuals of *Anelosimus eximius* cooperating in the capture of a big moth within their nest. Photo taken by Guadalupe Corcobado in the rain forest in the Jatun Sacha Biological Stations, province of Napo, Ecuador.

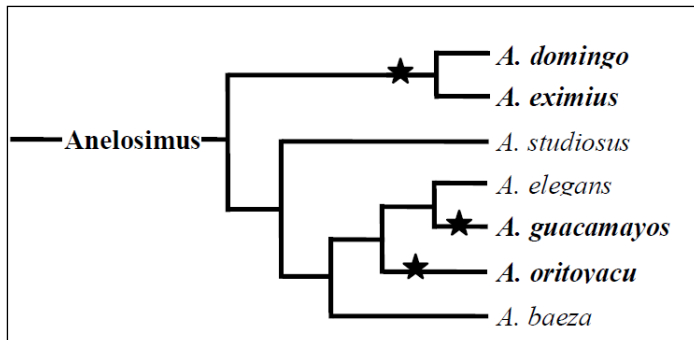
We followed the methods described in (Corcobado et al. 2010) to induce bridging in the laboratory. We placed the spider on the top of a 27 cm high wire stand, located between a blowing fan (3 m away) and a plant (30 cm away), so that the air directed towards the plant any silk released by the spider. Air speed at the top of the stand was 0.6 - 0.8 m·s<sup>-1</sup>. If spiders had not started bridging two minutes after their release, we tried to induce them to bridge by poking them gently with a

paint brush. Trials were either finished when the spider reached the plant after a successful bridging or 8 minutes after we first poked them. We recorded the result of the trial, the number of poking events until the spider started bridging, and the bridging speed (i.e., once the spider started walking upside-down hanging from the silk line, bridging speed is the distance covered divided by the time required to cover that distance). Time was measured from recordings in a JVC EVERIO GZ-MG575 video camera, while the distance covered was measured *in situ* using measuring tape to 0.1 cm precision. For those spiders (29 out of 241) that failed to bridge in the first trial, we ran a second trial, leaving spiders at least two hours to recover between trials. Of these 29 spiders, 17 finally bridged.

After the trials were finished, all spiders were frozen and preserved in 70% ETOH. We measured the size of specimens under a dissection microscope. (All animals were measured by the same observer –GC– with high intra-observer repeatability:  $R = 0.94$ ;  $p < 0.001$ ;  $n = 20$ ). We measured body size as carapace width (CW) and the first tibia length (TI1L) as an estimate of leg length.

### Statistical trials

*Comparative analysis.* To correct for the non-independence due to common ancestry of species (Grafen 1989) we performed General Least Square analyses (GLS), as implemented in R using the package PHYLOGR (Diaz-Uriarte & Garland 2007). Analyses were based on the phylogeny of (Agnarsson et al. 2007). Because branch length is unknown for this phylogeny we assigned all branches the same arbitrary value of one. Phylogenetic distance matrices were calculated using the PDTREE procedure within the statistical package PDAP (Garland et al. 1992) and imported into PHYLOGR. Figure 2 shows the phylogeny of our sample of species. In order to compare males and females, we added to each tip one more node with two branches, representing the two sexes of each species. So, in our tree for the comparative analyses we had average values for males and females of each species at the tips.



**Figure 2:** Phylogeny of the spiders used for the comparative analyses based in previous published phylogenies of the genus *Anelosimus* (Agnarsson 2006; Agnarsson et al. 2007). Boldface font, social species; Normal font, subsocial species. The stars indicate independent origins of sociality.

*Rank of sociality:* Although the traditional classification in social and subsocial spiders is appropriate for most species (Aviles 1997; Lubin & Bilde 2007), some species appear intermediate between these two categories (e.g., Aviles et al. 2007; Riechert & Jones 2008). Furthermore, within any one category there appears to be a gradation in level of sociality (Agnarsson 2006; Purcell & Aviles 2007). Thus, instead of using sociality as a categorical variable with two levels, social vs subsocial, we constructed a continuous variable, ranking our seven species from least (assigned a value of 1) to the most (assigned a value of 7) social. We established the ranking a priori based on a combined assessment of the median of the instar in which dispersal occurs and the proportion of nests with more than one adult female (Table S1), with species that dispersed later in their life cycle and had a greater proportion of nests with multiple adult females deemed to have a higher sociality rank (Purcell & Aviles 2007). According to this criterion, in the decreasing order of sociality our sample of species was ranked as: *A. domingo* 7; *A. eximius* 6; *A. oritoyacu* 5; *A. guacamayos* 4; *A. baeza* 3; *A. elegans* 2; *A. studiosus* 1. We note that the measures of dispersal instar and proportion of social nests are specific to the populations from which samples for this study were taken and may not be general for the species as a whole. Additionally, the estimates for *A. oritoyacu* should be considered preliminary, as this is a recently discovered species for which little is known (Aviles & Purcell 2010). To check the robustness of our results, all analyses were repeated considering sociality as a categorical variable with two levels (social = 1; subsocial = 0); since results were qualitatively very similar, only the more relevant ones are reported in the manuscript.

*Selecting the final model:* For each of the predictions that we wanted to test, we initially ran a GLS with the response variable and all the predictor variables we

considered could have an effect in the response variable. Sex (females = 1, males = 0) and its interactions with other independent variables were introduced in the initial model. Starting with the higher order interactions, we then performed backward removal of the interaction terms that were furthest away from significance ( $P > 0.30$ ). To graphically display the results of each predictor in the final model, we used partial regression plots (Moya-Laraño & Corcobado 2008).

*Testing prediction (i): Across taxa, spiders decrease their propensity to bridge as the degree of sociality increases.* We studied the tendency of the spiders to disperse by bridging through two dependent variables. First, we calculated for each sex and species the proportion of individuals that bridged without needing stimulation (bridging propensity). Second, we recorded for each sex and species the average number of stimulations needed to persuade them to bridge. In both cases the initial models included body size (CW), level of sociality, sex, and the interaction of sex with the other two variables as predictors.

*Testing prediction (ii): Across taxa, spiders decrease their ability to disperse by bridging as the degree of sociality increases.* We analyzed the ability of the spiders to bridge including the bridging speed of each spider during a continuous bout of running upside-down as the dependent variable. The predictor variables introduced in the initial model were TI1L, residuals of CW (because CW and TI1L were highly correlated we used the residuals of CW on TI1L to get a measurement of size independent from leg length), room temperature during the bridging trial, level of sociality, sex, and all the interactions between sex and the remaining independent variables. However, because the number of variables was high relative to the number of cases, this model had low statistical power. We thus ran the analysis for males and females separately.

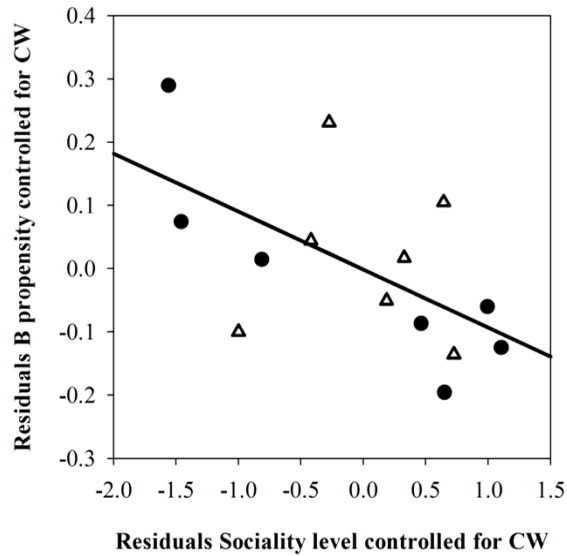
*Testing predictions (iii) and (iv): across taxa, spiders have body shapes less specifically adapted to bridging (relatively shorter legs relative to their body size) as the degree of sociality increases.* To test this hypothesis we analyzed the relationship between leg length (TI1L) and body size (CW) across the different species of *Anelosimus*, using log transformed variables. Thus, the response variable was TI1L (log-transformed), and the initial model included CW (log-transformed), level of sociality, sex, and the interactions between sex and the other predictors.

## Results

All species we tested proved to be good bridgers, in agreement with previous results extracted from another specie in the genus *Anelosimus* (Moya-Laraño et al. 2008). Across species, the proportion of individuals who bridged at the end of the trials for each species ranged from 75 to 100% in females and from 86 to 100% in males. Nevertheless, we observed strong differences among species in the tendency to bridge.

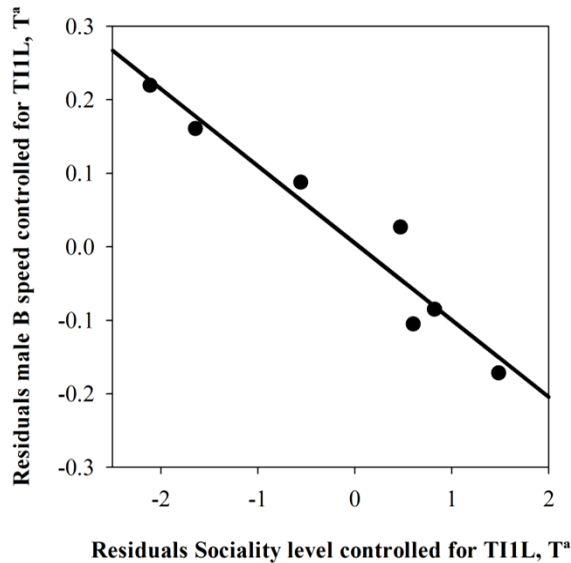
*Prediction i: the propensity to disperse by bridging decreases with the level of sociality.* Both measurements of the tendency to disperse, the proportion of individuals that bridged without stimulation, and the average number of times that we had to stimulate individuals before they bridged, were consistent with our prediction that the tendency to disperse by bridging decreases as the level of sociality increases. Level of sociality was the only variable that had a significant effect on the proportion of spiders that bridged without stimulation ( $t(11) = -2.42$ ,  $p = 0.034$ ) (Table S3, Fig. 3), with no differences between males and females. Similar results were obtained when we measured the tendency to bridge as the mean number of stimulations needed to persuade spiders to bridge: the more social species needed on average a larger number of stimulations to bridge ( $t(11) = 2.27$ ,  $p = 0.044$ ). But, in this case a significant effect of sex was also detected, with females needing more stimulations to bridge than males ( $t(11) = 2.46$ ,  $p = 0.032$ ) (Table S4). When we considered sociality as a categorical variable with two levels (social vs subsocial), the same trend was found although the results were in this case not significant (final model for bridging propensity:  $t_{\text{categorical sociality}}(10) = -1.81$ ,  $p = 0.100$ ; final model for number stimulations to bridge:  $t_{\text{categorical sociality}}(11) = 1.88$ ,  $p = 0.086$ ).





**Figure 3:** Partial regression plot showing the partial relationship between bridging propensity and the level of sociality. The Y axis shows residuals of bridging propensity (bp) controlled for carapace width (CW); the X axis shows residuals of social level controlled for CW. Males are represented by black circles and females by empty triangles.

*Prediction ii: the ability to disperse by bridging decreases with the level of sociality.* We used bridging speed (i.e., the speed at which the spider ran upside-down hanging from the silk line) as a proxy for the ability to disperse. The initial analyses showed very different pattern between the sexes, so we decided to analyze data for males and females separately. When sociality level was used as a continuous variable, none of the variables tested had significant effects on the bridging speed of females (Table S5a). The bridging speed of males, on the other hand, increased with leg length ( $t(3) = 19.04, p < 0.001$ ) and decreased with sociality level ( $t(3) = -6.43, p = 0.008$ ). We also detected a significant effect of temperature ( $t(3) = 4.98, p = 0.016$ ). Thus, after controlling for temperature and leg length, the males of the more social spiders bridged at lower speed, and once we controlled for temperature and level of sociality, males with longer legs bridged at higher speed (Table S5b, Fig. 4). Although body size was not included in the selected model, leg length was still significant in the full model (leg length,  $t(2) = 13.57, p = 0.005$ ), which also included body size, revealing that the observed pattern is more probably due to the relatively length of the leg controlled for the body size, than to the absolute leg length.



**Figure 4:** Partial regression plot showing the partial relationship between male bridging speed and level of sociality. The Y axis shows residuals of bridging speed (bp) controlled for tibia length (T11L) and average bridging temperature (T<sup>a</sup>); the X axis shows residuals of social level controlled for T11L and T<sup>a</sup>.

The analysis comparing social *versus* subsocial species (categorical sociality) showed very similar results for males: leg length had a positive effect ( $t(3) = 13.15$ ,  $p = 0.001$ ) while there was a trend for social males to bridge more slowly than subsocial ones ( $t(3) = -2.56$ ,  $p = 0.084$ ). For females the final model showed a trend for bridging speed to increase with tibia length ( $t(4) = 2.45$ ,  $p = 0.070$ ) and a negative effect of categorical sociality, with social species bridging slower than subsocial ones ( $t(4) = -3.96$ ,  $p = 0.017$ ).

*Predictions iii and iv: more social species have relatively shorter legs in relation to their body size, with this effect being stronger in males than in females.* We tested predictions iii and iv comparing the relationship between leg length and body size for males and females of different species. There was a significant interaction between sex and sociality level ( $t(9) = 2.89$ ,  $p = 0.018$ ). Leg length (relative to body size) increased with the level of sociality in females and decreased in males (Table S6). Using sociality as a categorical variable resulted in a similar pattern in relation to differences between the sexes ( $t(8) = -3.20$ ,  $p = 0.013$ ), but the interaction between sex and categorical sociality was not significant, even though a tentative trend was found ( $t(8) = 1.44$ ,  $p = 0.187$ ).

## Discussion

We found that the evolution of sociality in spiders tightly correlates with changes in dispersal propensity, dispersal performance and morphological traits affecting dispersal ability. Although it was previously proposed that the evolution of the highest degree of sociality is associated with the loss of a pre-mating dispersal phase (reviewed in Lubin & Bilde 2007), the suggestion was based on data on age classes and the analysis of population genetic structure. No previous study had directly measured dispersal behaviour following a functional and mechanistic approach as we have done here. In this paper, we provide the first direct evidence that the propensity and, more important, the ability to disperse, decrease across a sociality gradient, as we had predicted

Several lines of evidence support this statement. First, the tendency to disperse by bridging was significantly and negatively correlated with level of sociality for both males and females. This result was observed regardless of whether the tendency to disperse was measured as the number of individuals who bridged without stimulation (Table S3, Fig. 3), or as the mean number of stimulations applied in order to persuade the spiders to bridge (Table S4). Second, at least for males, the sex that is mainly responsible for mate searching in spiders (Foelix 1996), dispersal ability (bridging speed) decreases when level of sociality increases (Table S5b, Fig. 4). This pattern was also confirmed when we analyzed sociality as a categorical variable (social vs subsocial). For females we only found a reduced ability to bridge related to sociality when we used sociality as a categorical variable. Although it has often been suggested that there may be a link between constraints on dispersal and the evolution from subsocial outbred to social inbred species in spiders (Aviles & Tufino 1998; Bilde et al. 2007; Lubin & Bilde 2007), as we have mentioned before, as far as we know this is the first direct evidence that the evolution of sociality in spiders has resulted in an evolutionary reduction of dispersal abilities. Another novel finding of the present study is that the reduction in the tendency and ability to disperse is progressive across the sociality gradient and

there is no pronounced threshold between the traditionally considered subsocial and social species. This result agrees with the idea that sociality in spiders, instead of being a discreetly categorical trait (social vs subsocial), is a continuous variable that groups together a broad list of behavioral characteristics related to group living (Agnarsson 2006; Purcell & Aviles 2007; Riechert & Jones 2008).

We found quite different patterns for males and females in terms of dispersal ability relative to body shape. In males bridging ability was positively and strongly correlated with leg length, after controlling for temperature and level of sociality (Table S5b), in agreement with pendulum biomechanics, which predicts a positive relationship between bridging speed and relative leg length (controlled for body size) (Moya-Laraño et al. 2008). Thus, males with longer legs have an advantage in bridging dispersal. Looking for the mechanisms responsible for a decreased ability to disperse associated with the evolution of sociality, we found a sex-specific change in body shape across species with different degrees of sociality (Table S6). Hence, males of the more social species have relatively shorter legs, i.e., a body shape less fitted for bridging (Moya-Laraño et al. 2008), than males of the less social species (Table S6). The observed pattern suggests that the selective pressure for efficient bridging is reduced when the level of sociality increases, leading to the evolution of a different body shape, perhaps better adapted to move inside the nest. However, the fact that the negative relationship between bridging ability and level of sociality remains significant even after controlling for leg length suggests that additional mechanisms, besides a reduction of the relative leg length, may be involved in the loss of bridging ability with increasing level of sociality in males. Conversely, in relation to females, we found that the females of the more social species have disproportionately longer legs (Table S6). Although this pattern could be explained by the observation that females seem to be responsible for new colony foundation in social spiders (Vollrath 1982; Lubin & Robinson 1982; Johannesen et al. 1998; Schneider et al. 2001; Johannesen et al. 2002; Johannesen et al. 2009b) we find it unlikely that female leg length has increased with sociality level to improve their dispersal abilities for two reasons. First, females decrease their tendency to disperse by bridging when the level of sociality increases (Tables S3 and S4, Fig. 3). Second, and most important, we found no relationship between female leg length and bridging speed when we considered sociality as a continuous variable (Table S5a).

In our opinion, more likely, an elongation of the relative leg length in females may have evolved because it would be advantageous in other behaviours related to the communal life style such as re-building the web. Social *Anelosimus* species are restricted to tropical areas where strong rains are very common, and consequently spiders need to invest a lot of time and energy rebuilding the web (Purcell & Aviles 2008), which, relative to the body size of the spiders, may be orders of magnitude larger in social than subsocial species. It is believed that males cooperate very little in the communal activities that take place inside the nest (reviewed in Lubin & Bilde 2007). Thus, social males are simultaneously released from the parallel needs of dispersing and nest repair, while social females must retain a high nest repair capability, thus potentially explaining why relative leg length decreases in males, but increases in females, as level of sociality increases.

It is necessary to point out that our study is only relevant to relative short distance dispersal mediated by bridging. In the context of social spiders, this kind of displacements characterizes the pre-mating phase in subsocial species (Aviles & Gelsey 1998; Lubin et al. 1998; Powers & Aviles 2003; Li & Kuan 2006), and is one of the main mechanisms whose suppression is responsible for the transition from subsocial to social systems in spiders (interindividual tolerance being the other). Although there is evidence for long-distance dispersal probably mediated by ballooning in *Stegodyphus* (Schneider et al. 2001; Johannesen et al. 2005; Johannesen et al. 2009a), another spider genus with multiple origins of sociality, such mechanism has not been documented for *Anelosimus*. In the future it would be interesting to test if the pattern of a reduced ability to disperse by bridging is also found in relation to long-distance dispersal and whether a pattern of loss of dispersal ability with level of sociality is found in other taxa, such as *Stegodyphus*, where species with different degrees of sociality and multiple origins of sociality occur (Kraus & Kraus 1990; Johannesen et al. 2007).

Within the less social spiders, the ones traditionally known as the group of subsocial spiders, dispersal seems a highly plastic trait as the proportion of dispersing individuals as well as the dispersal timing may change depending on environmental conditions (Ruttan 1990; Jones & Parker 2000; Jones & Parker 2002; Jones et al. 2007; Riechert & Jones 2008). By contrast, once the highest level of

sociality is achieved (as in the traditionally known as permanent social spiders) the lack of a pre-mating dispersal phase seems a fixed character, and the foundation of new colonies takes place only by groups of mated females and once the maternal colony size becomes too large (Vollrath 1982; Lubin & Robinson 1982; Schneider et al. 2001). This often results in the establishment of new nests at few meters from the source colony (Vollrath 1982; Lubin & Robinson 1982), and only males move short distances around the original colony (Lubin et al. 2009). The proposed explanation for individuals of the more social species giving up dispersal relies on the unusually high costs of dispersal, due to the special environmental conditions of habitats where social spiders inhabit and the fact that dispersal does not contribute to prevent inbreeding, as within a local area, most of the colonies are genetically very similar (Johannesen & Lubin 2001; Johannesen et al. 2002; Smith et al. 2009; Johannesen et al. 2009b). Our results add a non-exclusive mechanistic level of explanation for this pattern. Those species with a high degree of sociality have diminished their ability to disperse in such a way that the potential costs associated to dispersal become very high and consequently, the probability to survive dispersal has become excessively low. Under this scenario, the benefits of group living would overcome the potential benefits of dispersal regardless of environmental variation.

Selection favouring the transition to sociality could differ from the mechanisms that maintain sociality. Maintenance would be achieved because reduced dispersal abilities would increase the costs and thus mortality risks associated with dispersal. While it is mostly agreed that sociality in spiders has evolved as a result of costs of dispersal and benefits of group living under some environmental conditions (reviewed in Aviles 1997; Lubin & Bilde 2007), we propose that the decrease in dispersal ability concomitant with the achievement of sociality introduces a positive feedback loop, contributing to the maintenance of sociality once it is achieved.

## Acknowledgements

This research was supported by a Spanish Ministry of Science and Education (FEDER/MEC) grant to J.M. (CGL2007-60520), a NSERC (National Sciences and Engineering Research Council of Canada) Discovery grant to L.A., and a pre-doctoral grant (FPI; ref: BES-2005-9234) from the Spanish Ministry of Science and Education (MEC) to GC. Our thanks to SIMBIOE (Sociedad para la Investigación y Monitoreo de la Biodiversidad Ecuatoriana) for sponsoring our research in Ecuador and to the Instituto Ecuatoriano de Recursos Naturales y Vida Silvestre for research permits (Research permit number: 027-08 IC-FAU-DNBAPVS/MA) . We also thank Dr. J.M. Guayasamín for allowing us to use his lab in the Pontificia Universidad Católica del Ecuador in Quito. We thank G. Iturralde, M. Salazar, M. Salomon and K. Whitaker for field assistance, and the Parque Nacional Antizana (Cocodrilos station), the Yanayacu and Jatun Sacha Biological Stations, and the people in the Baeza, San Antonio de Pichincha, and Yanayacu areas, for permitting us to use their land for our study. Thanks also to M. Salomon, and J. Purcell for constructive comments to this work.

## References

- Agnarsson,I. 2006. A revision of the New World eximius lineage of *Anelosimus* (Araneae, Theridiidae) and a phylogenetic analysis using worldwide exemplars. *Zoological Journal of the Linnean Society* 146, 453-593.
- Agnarsson,I., Aviles,L., Coddington,J.A. & Maddison,W.P. 2006a. Sociality in Theridiid spiders: Repeated origins of an evolutionary dead end. *Evolution* 60, 2342-2351.
- Agnarsson,I., Barrantes,G. & May-Collado,L.J. 2006b. Notes on the biology of *Anelosimus pacificus* Levi, 1963 (Theridiidae, Araneae) - evidence for an evolutionary reversal to a less social state. *Journal of Natural History* 40, 2681-2687.
- Agnarsson,I., Maddison,W.P. & Aviles,L. 2007. The phylogeny of the social *Anelosimus* spiders (Araneae : Theridiidae) inferred from six molecular loci and morphology. *Molecular Phylogenetics and Evolution* 43, 833-851.
- Agnarsson,I., Maddison,W.P. & Aviles,L. 2010. Complete separation along matrilineal lines in a social spider metapopulation inferred from hypervariable mitochondrial DNA region. *Molecular Ecology* 19, 3052-3063.
- Aisenberg,A., Viera,C. & Costa,F.G. 2007. Daring females, devoted males, and reversed sexual size dimorphism in the sand-dwelling spider *Allocosa brasiliensis* (Araneae, Lycosidae). *Behavioral Ecology and Sociobiology* 62, 29-35.
- Aviles,L. 1997. Causes and consequences of cooperation and premanent-sociality in spiders. In: *The evolution of social behaviour in insects and arachnids*. J.C. Choe & B. Crespi (Ed. by J.C. Choe & B. Crespi), pp. 476-498. Cambridge, Cambridge University Press.
- Aviles,L. & Gelsey,G. 1998. Natal dispersal and demography of a subsocial *Anelosimus* species and its implications for the evolution of sociality in spiders. *Canadian Journal of Zoology-Revue Canadienne de Zoologie* 76, 2137-2147.
- Aviles,L. & Tufino,P. 1998. Colony size and individual fitness in the social spider *Anelosimus eximius*. *American Naturalist* 152, 403-418.
- Aviles,L. & Bukowski,T.C. 2006. Group living and inbreeding depression in a subsocial spider. *Proceedings of the Royal Society B-Biological Sciences* 273, 157-163.



- Aviles,L., Agnarsson,I., Salazar,P.A., Purcell,J., Iturralde,G., Yip,E.C., Powers,K.S. & Bukowski,T.C. 2007. Natural history miscellany - Altitudinal patterns of spider sociality and the biology of a new midelevation social *Anelosimus* species in Ecuador. *American Naturalist* 170, 783-792.
- Aviles,L. & Purcell,J. *In press*. *Anelosimus oritoyacu*, a cloud forest social spider with only slightly female biased primary sex ratios. *Journal of Arachnology*.
- Bilde,T., Lubin,Y., Smith,D., Schneider,J.M. & Maklakov,A.A. 2005. The transition to social inbred mating systems in spiders: role of inbreeding tolerance in a subsocial predecessor. *Evolution* 59, 160-174.
- Bilde,T., Coates,K.S., Birkhofer,K., Bird,T., Maklakov,A.A., Lubin,Y. & Aviles,L. 2007. Survival benefits select for group living in a social spider despite reproductive costs. *J. Evol. Biol.* 20, 2412-2426.
- Bonte,D., De Clercq,N., Zwertvaegher,I. & Lens,L. 2009. Repeatability of dispersal behaviour in a common dwarf spider: evidence for different mechanisms behind short- and long-distance dispersal. *Ecological Entomology* 34, 271-276.
- Charlesworth,D. & Charlesworth,B. 1987. Inbreeding Depression and Its Evolutionary Consequences. *Annual review of ecology and systematics* 18, 237-268.
- Clobert,J., Danchin,E., Dhondt,A.A. & Nichols,J.D. 2001. *Dispersal*. New York: Oxford University Press.
- Corcobado,G., Rodriguez-Girones,M.A., De Mas,E. & Moya-Laraño,J. 2010. Introducing the refined gravity hypothesis of extreme sexual size dimorphism. *Bmc Evolutionary Biology* 10, 236.
- Diaz-Uriarte,R. & Garland,T. PHYLOGR: Functions for phylogenetically based statistical analyses. Diaz-Uriarte,R. 2007. 3-3-2009.
- Foelix,R.F. 1996. *Biology of Spiders*. 2<sup>nd</sup> edn. Oxford: Oxford University Press.
- Garland,T.Jr., Harvey,P.H. & Ives,A.R. 1992. Procedures for the Analysis of Comparative Data Using Phylogenetically Independent Contrasts. *Systematic Biology* 41, 18-32.
- Grafen,A. 1989. The Phylogenetic Regression. *Philosophical Transactions of the Royal Society of London Series B-Biological Sciences* 326, 119-157.
- Henschel,J.R. 1998. Predation on social and solitary individuals of the spider *Stegodyphus dumicola* (Araneae, Eresidae). *Journal of Arachnology* 26, 61-69.
- Johannesen,J., Baumann,T., Seitz,A. & Veith,M. 1998. The significance of relatedness and gene flow on population genetic structure in the subsocial spider *Eresus cinnaberinus* (Araneae : Eresidae). *Biological Journal of the Linnean Society* 63, 81-98.

- Johannesen, J. & Lubin, Y. 1999. Group founding and breeding structure in the subsocial spider *Stegodyphus lineatus* (Eresidae). *Heredity* 82, 677-686.
- Johannesen, J. & Lubin, Y. 2001. Evidence for kin-structured group founding and limited juvenile dispersal in the sub-social spider *Stegodyphus lineatus* (Araneae, Eresidae). *Journal of Arachnology* 29, 413-422.
- Johannesen, J., Hennig, A., Dommermuth, B. & Schneider, J.M. 2002. Mitochondrial DNA distributions indicate colony propagation by single matri-lineages in the social spider *Stegodyphus dumicola* (Eresidae). *Biological Journal of the Linnean Society* 76, 591-600.
- Johannesen, J., Lubin, Y., Laufs, T. & Seitz, A. 2005. Dispersal history of a spider (*Stegodyphus lineatus*) across contiguous deserts: vicariance and range expansion. *Biological Journal of the Linnean Society* 84, 739-754.
- Johannesen, J., Lubin, Y., Smith, D.R., Bilde, T. & Schneider, J.M. 2007. The age and evolution of sociality in *Stegodyphus* spiders: a molecular phylogenetic perspective. *Proceedings of the Royal Society B-Biological Sciences* 274, 231-237.
- Johannesen, J., Moritz, R.F.A., Simunek, H., Seibt, U. & Wickler, W. 2009a. Species cohesion despite extreme inbreeding in a social spider. *Journal of Evolutionary Biology* 22, 1137-1142.
- Johannesen, J., Wickler, W., Seibt, U. & Moritz, R.F.A. 2009b. Population history in social spiders repeated: colony structure and lineage evolution in *Stegodyphus mimosarum* (Eresidae). *Molecular Ecology* 18, 2812-2818.
- Johnson, M.L. & Gaines, M.S. 1990. Evolution of Dispersal - Theoretical-Models and Empirical Tests Using Birds and Mammals. *Annual review of ecology and systematics* 21, 449-480.
- Jones, T.C. & Parker, P.G. 2000. Costs and benefits of foraging associated with delayed dispersal in the spider *Anelosimus studiosus* (Araneae, Theridiidae). *Journal of Arachnology* 28, 61-69.
- Jones, T.C. & Parker, P.G. 2002. Delayed juvenile dispersal benefits both mother and offspring in the cooperative spider *Anelosimus studiosus* (Araneae : Theridiidae). *Behavioral Ecology* 13, 142-148.
- Jones, T.C., Riechert, S.E., Dalrymple, S.E. & Parker, P.G. 2007. Fostering model explains variation in levels of sociality in a spider system. *Animal Behaviour* 73, 195-204.
- Klein, B.A., Bukowski, T.C. & Aviles, L. 2005. Male residency and mating patterns in a subsocial spider. *Journal of Arachnology* 33, 703-710.
- Kraus, O. & Kraus, M. 1990. The genus *Stegodyphus*: systematics, biogeography and sociality (Araneida, Eresidae). *Acta Zoologica Fennica* 190, 223-228.

- Li,D. & Kuan,J.Y.X. 2006. Natal dispersal and breeding dispersal of a subsocial spitting spider (*Scytodes pallida*) (Araneae : Scytodidae), from Singapore. *Journal of Zoology* 268, 121-126.
- Lubin,Y. & Robinson,M.H. 1982. Dispersal by Swarming in A Social Spider. *Science* 216, 319-321.
- Lubin,Y., Hennicke,J. & Schneider,J. 1998. Settling decisions of dispersing *Stegodyphus lineatus* (Eresidae) young. *Israel Journal of Zoology* 44, 217-225.
- Lubin,Y. & Bilde,T. 2007. The evolution of sociality in spiders. *Advances in the Study of Behavior, Vol 37* 37, 83-145.
- Lubin,Y., Birkhofer,K., Berger-Tal,R. & Bilde,T. 2009. Limited male dispersal in a social spider with extreme inbreeding. *Biological Journal of the Linnean Society* 97, 227-234.
- Moya-Laraño,J. & Corcobado,G. 2008. Plotting partial correlation and regression in ecological studies. *Web Ecology* 8, 35-46.
- Moya-Laraño,J., Vinkovic,D., De Mas,E., Corcobado,G. & Moreno,E. 2008. Morphological Evolution of Spiders Predicted by Pendulum Mechanics. *PLoS ONE* 3.
- Perrin,N. & Mazalov,V. 2000. Local competition, inbreeding, and the evolution of sex-biased dispersal. *American Naturalist* 155, 116-127.
- Peters,H.M. 1990. On the structure and glandular origin of bridging lines used by spiders for moving to distant places. *Acta Zoologica Fennica* 190, 309-314.
- Powers,K.S. & Aviles,L. 2003. Natal dispersal patterns of a subsocial spider *Anelosimus cf. jucundus* (Theridiidae). *Ethology* 109, 725-737.
- Purcell,J. & Aviles,L. 2007. Smaller colonies and more solitary living mark higher elevation populations of a social spider. *Journal of Animal Ecology* 76, 590-597.
- Purcell,J. & Aviles,L. 2008. Gradients of precipitation and ant abundance may contribute to the altitudinal range limit of subsocial spiders: insights from a transplant experiment. *Proceedings of the Royal Society B-Biological Sciences* 275, 2617-2625.
- Riechert,S.E. & Jones,T.C. 2008. Phenotypic variation in the social behaviour of the spider *Anelosimus studiosus* along a latitudinal gradient. *Animal Behaviour* 75, 1893-1902.
- Ruch,J., Heinrich,L., Bilde,T. & Schneider,J.M. 2009. The evolution of social inbreeding mating systems in spiders: limited male mating dispersal and lack of pre-copulatory inbreeding avoidance in a subsocial predecessor. *Biological Journal of the Linnean Society* 98, 851-859.

- Ruttan,L.M. 1990. Experimental Manipulations of Dispersal in the Subsocial Spider, Theridion-Pictum. *Behavioral Ecology and Sociobiology* 27, 169-173.
- Schneider,J.M., Roos,J., Lubin,Y. & Henschel,J.R. 2001. Dispersal of Stegodyphus dumicola (Araneae, Eresidae): They do balloon after all! *Journal of Arachnology* 29, 114-116.
- Smith,D., van Rijn,S., Henschel,J., Bilde,T. & Lubin,Y. 2009. Amplified fragment length polymorphism fingerprints support limited gene flow among social spider populations. *Biological Journal of the Linnean Society* 97, 235-246.
- Vollrath,F. 1982. Colony foundation in a social spider. *Zeitschrift für Tierpsychologie* 60, 313-324.
- Ward,D. & Lubin,Y. 1993. Habitat Selection and the Life-History of A Desert Spider, Stegodyphus-Lineatus (Eresidae). *Journal of Animal Ecology* 62, 353-363.

## Supporting Information

**Table S1: Classification in social or subsocial, locations, coordinates and habitat description where we collected each of the species.** Median dispersal instar and proportion of social nests for each species where used to define the continuous sociality ranking.

Species	Location	Province	Coordinates	Habitat	Median Dispersal Instar*	Proportion Social Nests*	Continuous Sociality ranking	Social/ Subsocial
<i>A. domingo</i>	Jatun Sacha	Napo	1.07254 S, 77.61561 W	Lowland rain forest	7	0.96	7	Social
<i>A. eximius</i>	Jatun Sacha	Napo	1.07254 S, 77.61561 W	Lowland rain forest	7	0.91	6	Social
<i>A. oritoyacu</i>	Baeza	Napo	0.46324 S, 77.87657 W	Montane cloud forest	7	>0.85, <0.96	5	Social
<i>A. guacamayos</i>	Cocodrilos	Napo	0.64928 S; 77.79460 W	Montane cloud forest	7	0.52	4	Social
<i>A. baeza</i>	Yanayacu	Napo	0.60660 S, 77.89469 W	Montane cloud forest	6	0.36	3	Subsocial
<i>A. elegans</i>	Cocodrilos	Napo	0.64928 S; 77.79460 W	Montane cloud forest	6	0.03	2	Subsocial
<i>A. studiosus</i>	San Antonio de Pichincha	Pichincha	0.00027 S, 78.45474 W	Semiarid	5	0.00	1	Subsocial

\*The data from variables Median dispersal instar (MDI) and Proportion of social nests (PSN) used to define the continuous sociality ranking came from different resources: *A. domingo* data from L. Avilés, unpublished data. *A. eximius* data, from Purcell and Avilés (2007). For *A. oritoyacu*, MDI: inferred from the fact that the species has as primary sex ratio bias, as reported in Avilés and Purcell *in press*; PSN: preliminary estimate based on L. Avilés, unpublished data. For *A. guacamayos* MDI: Iturralde, G. 2004. Evolución de proporciones de sexos desviadas en arañas sociales de la Amazonía Ecuatorian. Licenciatura Thesis, Pontificia Universidad Católica del Ecuador; PSN: data from Avilés *et al.* (2007). For *A. baeza*, MDI: G. Corcobado, unpublished data; PSN: L. Avilés, unpublished data. For *A. elegans* MDI: Iturralde (2004); PSN: K. Samuk and L. Avilés, unpublished data. *A. studiosus* data from L. Avilés, unpublished data.

**Table S2: Summary of data used in the analysis.** The values are shown for each sex and species. *Sociality level* is the level of sociality assigned for that particular species, *n* is the number of individuals tested. For the variables *carapace width*, *first tibia length*, *bridging temperature*, *number of stimulations applied* and *bridging speed* the data shown are Mean  $\pm$  SD. *Proportion bridging without stimulation* shows the proportion of individuals who bridged intentionally without needing any stimulation, while *Total proportion bridging* is referred to the total proportion of successful bridging at the end of the trials regardless stimulation.

Specie	Sociality level	sex	n	Mean $\pm$ SD Carapace width (mm)	Mean $\pm$ SD First tibia length (mm)	Mean $\pm$ SD Bridging Temperature ( $^{\circ}$ C)	Mean $\pm$ SD Number of stimulations	Proportion bridging without stimulation	Total proportion bridging	Mean $\pm$ SD Bridging speed (cm/s)
A. domingo	7	female	14	1.05 $\pm$ 0.11	1.50 $\pm$ 0.16	21.75 $\pm$ 0.65	11.65 $\pm$ 8.22	0.00	0.93	3.90 $\pm$ 0.86
A. domingo	7	male	14	0.76 $\pm$ 0.03	1.06 $\pm$ 0.07	21.94 $\pm$ 1.07	9.46 $\pm$ 8.38	0.00	0.86	2.81 $\pm$ 1.03
A. eximius	6	female	17	1.51 $\pm$ 0.15	2.48 $\pm$ 0.20	22.01 $\pm$ 0.79	13.00 $\pm$ 7.75	0.00	1.00	4.78 $\pm$ 1.64
A. eximius	6	male	14	1.03 $\pm$ 0.10	1.83 $\pm$ 0.23	21.66 $\pm$ 0.47	9.92 $\pm$ 7.82	0.00	0.86	4.24 $\pm$ 1.41
A. oritoyacu	5	female	18	1.29 $\pm$ 0.06	1.47 $\pm$ 0.08	17.97 $\pm$ 0.36	6.11 $\pm$ 6.99	0.28	1.00	3.74 $\pm$ 1.02
A. oritoyacu	5	male	17	1.08 $\pm$ 0.04	1.52 $\pm$ 0.08	18.08 $\pm$ 0.37	5.71 $\pm$ 7.60	0.47	0.94	3.28 $\pm$ 0.95
A. guacamayos	4	female	24	1.39 $\pm$ 0.09	1.81 $\pm$ 0.11	19.10 $\pm$ 2.31	8.58 $\pm$ 9.28	0.42	0.75	3.28 $\pm$ 1.21
A. guacamayos	4	male	15	1.03 $\pm$ 0.04	1.57 $\pm$ 0.07	18.94 $\pm$ 1.23	3.80 $\pm$ 5.22	0.27	1.00	3.74 $\pm$ 0.97
A. baeza	3	female	20	1.48 $\pm$ 0.13	1.85 $\pm$ 0.09	19.70 $\pm$ 3.91	0.50 $\pm$ 1.14	0.85	1.00	4.69 $\pm$ 1.81
A. baeza	3	male	19	1.11 $\pm$ 0.09	1.70 $\pm$ 0.20	19.54 $\pm$ 3.74	2.32 $\pm$ 2.69	0.58	1.00	4.10 $\pm$ 1.39
A. elegans	2	female	20	1.41 $\pm$ 0.06	1.85 $\pm$ 0.09	19.85 $\pm$ 1.76	8.85 $\pm$ 9.48	0.40	0.90	4.66 $\pm$ 1.28
A. elegans	2	male	17	0.94 $\pm$ 0.04	1.36 $\pm$ 0.11	18.64 $\pm$ 2.57	5.28 $\pm$ 4.68	0.18	0.94	3.45 $\pm$ 1.39
A. studiosus	1	female	15	1.28 $\pm$ 0.04	1.70 $\pm$ 0.13	22.03 $\pm$ 1.11	3.13 $\pm$ 6.90	0.67	1.00	4.75 $\pm$ 1.68
A. studiosus	1	male	17	1.03 $\pm$ 0.07	1.88 $\pm$ 0.20	21.75 $\pm$ 0.96	0.24 $\pm$ 0.56	0.82	1.00	4.87 $\pm$ 1.53

**Table S3: Final model for the response variable bridging propensity (BP).** Proportion of individuals (calculated for females and males separately) that bridged without stimulation, males and females combined in one analysis. CW = carapace width.

<b>Table S3) GLS: Dependent variable BP</b>				
<b>Independent Variable</b>	<b>Estimate</b>	<b>SE</b>	<b>t-value</b>	<b>P</b>
CW	0.1937	0.1726	1.122	0.2856
<b>Sociality level</b>	<b>-0.0917</b>	<b>0.0380</b>	<b>-2.416</b>	<b>0.0343</b>

**Table S4: Final model for the response variable Mean number of stimulations applied in order to persuade the spiders to bridge.** Average numbers are separately calculated for females and males of each species. Males and females combined in one analysis. Sex is codified as 1 for females and 0 for males.

<b>Table S4) GLS: Mean number of stimulations</b>				
<b>Independent Variable</b>	<b>Estimate</b>	<b>SE</b>	<b>t-value</b>	<b>p</b>
Sex	2.1588	0.8769	2.462	0.0316
<b>Sociality level</b>	<b>1.1501</b>	<b>0.5069</b>	<b>2.269</b>	<b>0.0444</b>

**Table S5:** Final model for the response variable bridging speed. Males and females were analyzed separately in two different analyses. Table S5a): Female bridging velocity (FBV) as a function of the residuals of female carapace width on tibia length (resFCW) and mean temperature during the bridging trials (FT<sup>a</sup>). Table S5b) Male bridging velocity as a function of male foreleg's tibia length (MTI1L), the level of sociality (social level) and mean temperature during the bridging trials (MT<sup>a</sup>).

<b>Table S5a) GLS: Dependent variable FBV</b>				
<b>Independent Variable</b>	<b>Estimate</b>	<b>SE</b>	<b>t-value</b>	<b>p</b>
resFCW	6.0839	2.9562	2.058	0.1087
FT <sup>a</sup>	0.4743	0.1974	2.402	0.0742

<b>Table S5b) GLS: Dependent variable MBV</b>				
<b>Independent Variable</b>	<b>Estimate</b>	<b>SE</b>	<b>t-value</b>	<b>p</b>
MTI1L	1.7902	0.0940	19.042	0.0003
<b>Sociality level</b>	<b>-0.1052</b>	<b>0.0163</b>	<b>-6.434</b>	<b>0.0076</b>
MT <sup>a</sup>	0.1402	0.0282	4.975	0.0156

**Table S6:** Leg length vs body size (carapace width) across species with different levels of sociality and sex. The response variable was the natural logarithm of the length of the foreleg's tibia length (LN\_TI1L). The response variables were: the natural logarithm of carapace width (LN\_CW), sociality level, sex (females codified as 1 and males codified as 0), and the interactions between sex and sociality level (sex\*sociality level).

<b>Table S6) GLS: LN_TI1L vs LN_CW, sociality level</b>				
<b>Independent Variable</b>	<b>Estimate</b>	<b>SE</b>	<b>t-value</b>	<b>p</b>
Intercept	0.6002	0.0863	6.955	< 0.0001
<b>LN_CW</b>	<b>1.4874</b>	<b>0.1983</b>	<b>7.499</b>	<b>&lt; 0.0001</b>
<b>Sex</b>	<b>-0.4425</b>	<b>0.0813</b>	<b>-5.441</b>	<b>0.0004</b>
Sociality level	-0.0242	0.0170	-1.427	0.1873
<b>Sex*Sociality level</b>	<b>0.0380</b>	<b>0.0131</b>	<b>2.894</b>	<b>0.0178</b>



# MANUSCRIPT V

## **Sprint vs cruise speed: Implications for natural and sexual selection**

Guadalupe Corcobado<sup>1\*</sup>, Miguel A. Rodríguez-Gironés<sup>1</sup>,

Jordi Moya-Laraño<sup>1</sup>

<sup>1</sup>Dpto. de Ecología Funcional y Evolutiva, Estación Experimental de Zonas Áridas, CSIC, Carretera de Sacramento, s/n. La Cañada de San Urbano, C.P. 04120. Almería, Spain.



## Resumen

1. Tanto la selección natural como la selección sexual pueden favorecer la evolución de incrementar el rendimiento locomotor (“*performance*”). Los individuos más rápido son favorecidos por selección natural cuando implica comportamientos que aumentan la supervivencia tales como escapar de depredadores. A través de la selección sexual, los individuos con mayor rendimiento locomotor pueden incrementar su éxito reproductivo tanto por selección inter-sexual (ej. Las hembras eligen a los individuos con mayor rendimiento locomotor), o por selección intra-sexual (ej. Competencia directa entre machos o competencia por orden de llegada por accede a las hembras).
2. La mayoría de los estudios que han investigado la relación entre morfología, rendimiento y eficacia biológica se han centrado en la máxima velocidad de *sprint* o la resistencia. Sin embargo, la velocidad de cruce –velocidad a la que un animal se mueve habitualmente–, que sería relevante en la selección sexual por orden de llegada, se ha evaluado raramente.
3. En este estudio, usamos cercados de campo para investigar la relación entre morfología y velocidad de *sprint* (ed. La velocidad a la que las arañas se escapan de sus depredadores) y velocidad de cruce (ed. La velocidad a la cual los machos buscan pareja) in machos de la tarántula mediterránea (*Lycosa tarantula*), así como la relación entre estos dos tipos de velocidades, las cuales se espera que estén sujetas a distintas presiones de selección en la naturaleza.
4. La velocidad de cruce disminuyó con el tamaño corporal y la velocidad de escape con la longitud de la pata. Interesantemente y contrariamente a las predicciones de la biomecánica, la condición corporal estuvo correlacionada positivamente con ambas velocidades. Dado que en esta población de *L. tarantula* las hembras se aparean preferentemente con los machos en mejor condición, y matan y consumen a los machos en peor condición, proponemos que la condición corporal podría actuar como un *handicap*, permitiendo a las hembras seleccionar los machos de mejor calidad para aparearse; ed. aquellos machos que maduren en mejor condición, puesto que sería los únicos suficientemente fuertes como para soportar una carga extra de peso sin sufrir una reducción en la movilidad.
5. La velocidad de cruce y la de escape no se correlacionaron. Por tanto, la velocidad de escape no puede ser usada para predecir la velocidad de cruce. Si estos resultados se confirman en otras especies, los estudios previos que han usado la velocidad de *sprint* para investigar cómo la selección por orden de llegada afecta la evolución del dimorfismo sexual en el tamaño deberían ser tomados con precaución puesto que las conclusiones sólo pueden ser entendidas en el contexto de escapar de los depredadores, y por tanto selección natural, no sexual.

**Palabras clave:** tamaño corporal, locomoción, *Lycosa tarantula*, búsqueda de pareja, morfología, rendimiento, velocidad de carrera, araña lobo.

## Abstract

1. Both natural and sexual selection can favour the evolution of increased locomotor performance. Faster individuals are favoured by natural selection when it targets behaviours that increase survival such as escaping from predators. Through sexual selection, best-performing individuals can increase reproductive success either by inter-sexual selection (e.g. females choose best-performing individuals), or intra-sexual selection (e.g. direct or scramble male competition to access females).
2. Most of the studies that have investigated the relationship between morphology, performance and fitness have focused on maximum sprint speed or endurance capacity. However, cruise speed –the speed at which animals routinely move–, which should be most relevant in sexual selection by scramble competition, has been rarely measured.
3. In this study, we used field enclosures to investigate the relationship between morphology, sprint speed (i.e. the speed at which spiders escape from predators) and cruise speed (i.e. the average speed at which males search for mates) in males of the Mediterranean tarantula (*Lycosa tarantula*), as well as the relationship between these two types of speeds, which are expected to be subject to different sources of selection in the wild.
4. Cruise speed decreased with body size and sprint speed with leg length. Interestingly, contrary to theoretical predictions of biomechanics, body condition was positively correlated with both speeds. Since in this population of *L. tarantula* females preferentially mate with males in better body condition, and kill and consume males in worse condition, we propose that body condition could act as a handicap, allowing females to select high-quality males as mates; i.e., those maturing in better condition, as these males would be the ones sufficiently strong to carry their extra-heavy loads around without suffering a reduction in mobility.
5. Cruise and escape speed were uncorrelated. Thus, escape speed cannot be used to predict cruise speed. If these results are confirmed in other species, previous studies that have used sprint speed to investigate how scramble competition affects the evolution of sexual size dimorphism should be treated with caution as conclusions can only be drawn in the context of escaping from predators, and thus natural, not sexual selection.

**Keywords:** body size, locomotion, *Lycosa tarantula*, mate searching, morphology, performance, running speed, wolf spider.

## Introduction

Both natural and sexual selection may affect the evolution of locomotor performance (e.g. running speed). Faster individuals are favoured by natural selection when it targets behaviours that increase survival such as predator avoidance, prey capture and intra-specific interactions (Pruitt & Husak 2010) and references therein). In the context of sexual selection, performance can increase reproductive success either by inter-sexual selection (e.g. when females prefer to mate with best-performing individuals), or intra-sexual selection (e.g. direct or scramble competition between males to access female (Husak & Fox 2008 and reference therein).

Numerous studies have investigated the evolution of the triple relationship morphology-performance-fitness. Two lines of research have emerged from these works. The first one has focused on the relationship between performance and fitness. Within this line many studies have evaluated natural selection on performance and the most common result is positive directional selection on performance (reviewed in Irschick *et al.* 2008). Although much less attention has been paid to the analysis of sexual selection on performance, recent studies have proposed that some performance traits, such as locomotor endurance, could be favoured by sexual selection via territorial defence, courtship behaviour or scramble competition (reviewed in Husak & Fox 2008).

A second line of work has focused on the relationship between morphology and performance. A strong link between these two parameters is a common pattern found across vertebrates (e.g. Billerbeck *et al.* 2001; Iriarte-Diaz 2002; Garland & Freeman 2005; Calsbeek & Irschick 2007; Johansson *et al.* 2010) and invertebrates (Fish & Nicastro 2003; Berwaerts *et al.* 2006), but the direction and strength of the relationship between body size and/or body shape and locomotor abilities differs across different taxa and depends on the type of habitat (Calsbeek 2008).

Focusing on performance during terrestrial locomotion, most of the advances have been achieved in lizards, making this taxon a model system. In these animals

some authors have identified a positive relationship between performance (i.e. sprint speed) and hind limb length (Losos 1990; Husak et al. 2006; Calsbeek & Irschick 2007), while others have shown that larger animals have higher sprint speeds (Miles 2004). In addition, numerous studies have shown evidence of both natural (e.g. Jayne & Bennett 1990; Miles 2004; Husak 2006) and sexual selection on locomotor abilities (Husak & Fox 2006; Husak et al. 2006; Husak et al. 2008; Husak & Fox 2008). Much more limited is our knowledge about terrestrial locomotor performance in other taxa. Within arthropods, different results have been obtained with different species. In a vegetation-dwelling widow spider species (*Latrodectus*, Theridiidae), sprint speed when walking on horizontal surfaces increased with body size (Brandt & Andrade 2007), while in four ground-dwelling spider species (families Lycosidae and Agelenidae) there was no relationship between body size and sprint speed (Pruitt 2010). Another study found a positive linear relationship between body size and sprint speed across instars/species for wandering, ground-dwelling species, and a curvilinear relationship (with sprint speed peaking at intermediate body sizes) for species that live upside down in their webs –a pattern which was predicted from the mechanics of animals moving as inverted pendulums (Moya-Laraño et al. 2008b *manuscript I of this thesis*)–. The relationship between mobility and morphology may be specially relevant in spiders because males are the searching sex and move at higher rates than females (Moya-Laraño et al. 2002b; but see De Mas et al. 2009).

However, it must be pointed out that most studies that have evaluated locomotor performance have been based on maximum sprint speed or endurance capacity (e.g. Irschick *et al.* 2008 and reference therein) while cruise speed – i.e. the average velocity at which an animal normally travels from place to place– has been rarely measured (but see Miles 2004). Cruise speed could be especially relevant in relation to sexual selection mediated by scramble competition (Moya-Laraño et al. 2002b; Husak & Fox 2008). Scramble competition offers better performing males an advantage during mate search (Andersson 1994). It is expected to be especially relevant in those species which live at low densities, and consequently show a low probability of encounter among individuals (Andersson 1994). At least four studies have investigated scramble competition in arthropods through measurements of mobility, using either mark-recapture techniques or comparing mated vs. unmated

phenotypes. Two of the studies found a positive relationship between body size and mobility (Biedermann 2002; Kelly et al. 2008), while three of them found a positive relationship between mobility and mating success (Foellmer & Fairbairn 2005; Moya-Laraño et al. 2007; Kelly et al. 2008). To our knowledge, the three-way relationship between morphological traits, cruise speed and sprint speed has not been investigated previously in any animal. Since sprint speed depends mostly on anaerobic metabolism, and cruise speed on aerobic metabolism (e.g. Prestwich 1983) and, as explained above, the two speeds may be related to different sources of selection in the wild (e.g. predator-prey interactions for sprint speed and sexual selection by scramble competition in cruise speed), it is important to test to what degree these two performance traits are correlated to each other and how they relate to morphological traits.

In order to understand how performance relates to morphology, the latter needs to be decomposed in all its traits. In principle, larger animals can move faster because their long legs allow longer steps (e.g. Bauwens et al. 1995). However, the opposite pattern is predicted by biomechanical models because if legs are excessively long relative to body size, joint torques will not work efficiently and speed will decrease with leg length (Moya-Laraño et al. 2008b *manuscript I of this thesis*). Furthermore, particularly in spiders, body size has two components, one fixed and structural at maturation (i.e. carapace width) and another that is highly flexible after the spider matures (i.e. body condition, estimated as either body mass or abdomen dimensions once controlled for fixed body size (e.g. Jakob et al. 1996; Moya-Laraño et al. 2008a). Body condition reflects the relative load carried by the spider while moving around, and according to the mechanics of inverted pendulums it should be negatively correlated with mobility (Moya-Laraño et al. 2008b *manuscript I of this thesis*). Nevertheless, in some species females prefer to mate with males in better condition (e.g. Cotton et al. 2006; Hebets et al. 2008). On the other hand, body condition may serve as an index of male quality if only high-quality males find enough resources to maintain a good body condition. In the particular case of ground-dwelling spiders, we propose that the use of body condition by females as a signal of male quality may be further stabilised by the handicap that good body condition constitutes for mate-searching males, making body condition a particularly reliable signal of male quality (Zahavi 1975): according to the

mechanics of inverted pendulums, a heavier load (better condition) should decrease running speed and thus only genetically faster males (i.e. those of higher quality) could afford to carry an extra-weight around. Two assumptions are needed to support this hypothesis: first, body condition should be positively associated to running speed and second, male body condition should be inheritable and more or less constant through the mating season.

Different performance traits may be determined by the same or different sets of morphological traits. If escape speed and cruise speed are positively correlated to each other and explained by the same morphological traits, then sexual and natural selection, acting on cruise and sprint performance respectively, could go in the same direction; at least to the degree that these two traits were positively genetically correlated. Alternatively, these two traits could be negatively correlated, reflecting a trade-off between sprint and cruise speed; or not correlated at all, which would mean that they would be free to evolve fully independently of each other (Lande 1982).



**Figure 1.** Male of *Lycosa tarantula* in the area of Cabo de Gata, Almería, SE Spain. This male shows two painted marks on second right and third left legs respectively used to identify the individual. Photo by Guadalupe Corcobado.

In this study, we used field enclosures to investigate the relationship between morphology, sprint speed (i.e. the speed at which the spider escapes from predators) and cruise speed (i.e. the average speed at which the male searches for mates) in males of the Mediterranean tarantula, *Lycosa tarantula* (L.) (Araneae, Lycosidae; Fig. 1). If step length was equally important for both sprint and cruise speed, we would predict a positive relationship between body size (and leg length) and both speeds, as well as a positive relationship between these two performance traits. If, on the other hand, the mechanics of inverted pendulums explained the relationship

between morphology and both speeds, we would predict a negative relationship between leg length and performance, and between body condition and performance, as well as a positive relationship between the two performance traits. However, since in this population females exert strong selection upon male body condition, by mating with males in better condition and killing and consuming males in worse condition (Rabameda-Bueno R, Aguado-de-la-Paz S, Fernández-Montraveta C, and Moya-Laraño J *unpublished data*), if females use body condition as a signal of male quality, stabilised by the locomotor handicap of carrying extra weight during displacements, we could expect a positive relationship between body condition and performance. Finally, if there is a sprint-cruise speed trade-off we predicted a negative correlation between both types of performance, and that different morphological traits would explain each type of performance.

## **Material and Methods**

### **Study system**

*L. tarantula* is a burrowing wolf spider which inhabits Mediterranean semi-arid environments (Moya-Laraño 1999). At maturation, males abandon their burrows and become errant searching for females, mostly during the night. Once they find a potential mate, they can cohabit with her for several days until they finally mate during the day (Moya-Laraño et al. 2003b; Moya-Laraño et al. 2004). We conducted our study in Cabo de Gata (36° 48' N, 02°08'W) Almería, SE Spain. In this area, the mating season varies among years but usually peaks late in June, early in July and ends by August (e.g. Moya-Laraño et al. 2002a; Moya-Laraño et al. 2003b; Rabameda-Bueno et al. 2008).

### **Capture and maintenance of individuals**

During approximately the peak of the mating season, between July 3<sup>rd</sup> and July 24<sup>th</sup> of 2007, we captured 70 adult males with the help of headlamps. Captured individuals were kept individually at room temperature in (Ø6.5cm x 10cm)



cylindrical jars. Performance trials were conducted almost immediately after capture (number of capture days prior to performance trials; Mean = 4.23; SD = 2.71; N=70). Once the trials finished, individuals were used as part of a capture-recapture field experiment (Corcobado G, Rodríguez-Gironés MA, Aguado-de-la-Paz S, and Moya-Laraño J *unpublished data*).

All males were weighed to the nearest 0.01g and the following morphological traits measured under a dissection microscope (nearest 0.1mm): carapace width, opisthosoma width, first and forth tibia length. All animals were measured by the same observer (GC) with high intra-observer repeatability: all  $R > 0.94$ ;  $p < 0.001$ ;  $n = 20$ .

### **Performance trials**

In order to carry out the trials under semi-natural conditions, to assess performance males were transferred to a 47.3 cm × 33.2 cm field enclosure, which was filled with sifted natural soil (mesh size: 2mm) up to 1 cm. Spiders were moved to the enclosure around midnight and were given all night for acclimation. Performance trials were carried out at dawn and ambient temperature was recorded.

*Cruise speed:* In order to evaluate cruise speed we used video cameras located approximately 1 m above the enclosures, with their focal axis perpendicular to the surface of the enclosure and recorded the movement trajectories of the spiders during 30 minutes. For each spider, we then analyzed the 10 first moving bouts that showed a clear lineal trajectory.

*Sprint or Escape speed:* After 30 minutes of free movement we measured sprint speed in the context of escaping behaviour from predators by gently touching the spider with our own hands. If necessary we touched the spiders several times until a good sprint speed trajectory was recorded. Hence, we measured sprint speed in the context of escaping behaviour. Hereafter we will indistinctly refer in the text to sprint or escape speed.

Either for cruise or escape speed, we extracted running speed (distance / time) from the video recording following the same procedure. First, for each animal,

we chose a sufficiently good trajectory; i.e., continuous and straight. To calculate the distance covered in each segment of the trajectory, we first measured the dimensions of the arena over the computer screen and then marked over the screen the Cartesian coordinates ( $x, y$ ) of the segment's starting and ending points. We then calculated the real Euclidean distance for each segment by re-scaling the coordinates to real dimensions. We measured the time spent to cover each trajectory segment using a chronometer during the reproduction of the video record. In order to reduce the potential error associated to the shortest trajectories ( $t < 1s$ ), we measured the time elapsed 3 times and then calculated the average time spent (we found high repeatability among estimates,  $R = 0.90$ ,  $p < 0.001$ ). All the video recordings were analyzed by the same observer (GC).

## Data analysis

*Repeatability:* Repeatability of either cruise speed or escape speed, as well as repeatability of body condition was assessed with within/among individual variance partitioning (Lessells & Boag 1987), using linear mixed-effects model (LMM) with restricted maximum likelihood (REML), as recommended by (Nakagawa & Schielzeth 2010). For repeatability of cruise speed we used the same 10 trajectory segments used to estimate average cruise speed for the 70 males. To calculate the repeatability of sprint speed, we induced escaping behaviour in 30 males until they completed two straight trajectories. Variables were Box-Cox transformed to adjust model residuals to normality. We ran repeatability analyses using the *rptR* library in R (<http://r-forge.r-project.org/projects/rptr>).

We applied the same statistical analysis to calculate repeatability of male body condition through de mating season. We used 55 males of *L. tarantula* of the same population which were part of a capture-recapture field experiment that took place concomitantly in the study area. Males were weighed before being liberated in the study area and then they were re-weighed when recaptured (number of days between the two weighing events; Mean = 19.64; SD = 5.66; N = 55). Body condition was calculated as the residuals of the cubic root of the mass on carapace width (Jakob et al. 1996; Moya-Laraño et al. 2008a).

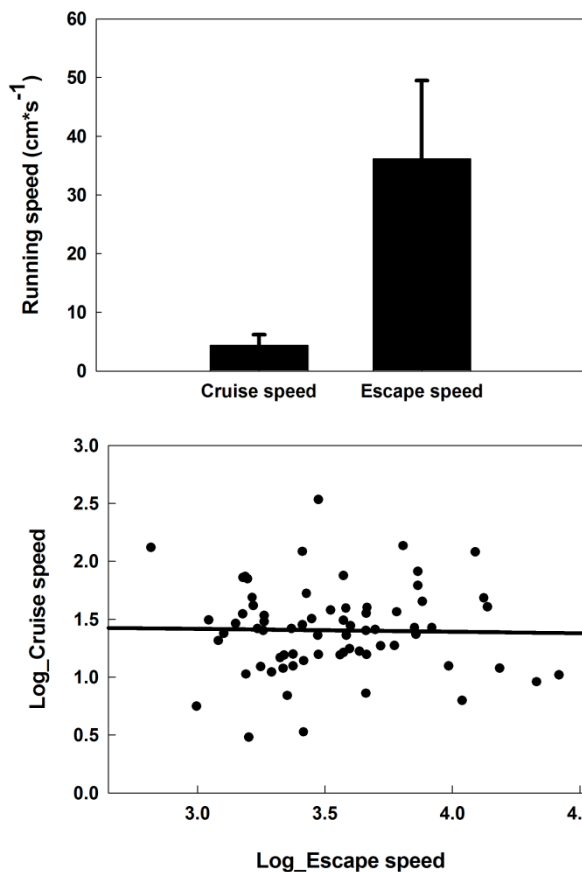
*Cruise vs. sprint speed.* In order to assess if our two types of trials truly reflected cruise vs. escape speed, we used a paired t-test to assess whether our presumed cruise speed was significantly and substantially lower than our presumed escape speed. Then, in order to assess if selection in one context (sexual selection by scramble competition) could affect selection on another (natural selection by escaping from predators) either positively or negatively (as in a trade-off), we tested for a correlation between cruise and sprint speed. An index of repeatability across contexts could not be estimated because the distribution of speeds was bimodal, as this included both cruise and sprint speeds. Both speed variables were log-transformed to meet the assumptions of parametric statistical analysis.

*Morphological predictors of cruise and sprint speed:* For analysis we used all our morphological measurements. Carapace width was used as an estimate of body size, since it is an estimate of structural body size that is independent of body condition (Foellmer & Moya-Laraño 2007). As for body condition itself, two estimates were used, body mass and opisthosoma width – controlled for a fixed estimate of body size by including carapace width or leg length together with body mass or opisthosoma in a multiple regression. Foreleg and backleg tibia lengths were used as estimates of leg length. We used the cubic root of body mass to bring this variable to the same scale than the other morphological variables, and then all morphological variables were log-transformed prior to analysis. Since the number of days that each male had remained in the container, as well as ambient temperature (Bauwens et al. 1995), could affect performance, we included these variables as potential predictors in the initial models. However, temperature had no significant effect in any of the response variables and was not included in further analyses. For each of the response variables (cruise and sprint speed) we ran generalized linear models including different combinations of the predictor variables explained above and estimated the most parsimonious model using the Akaike's Information Criterion (AIC) corrected for small sample sizes (Akaike 1987; Hurvich & Tsai 1989; Burnham & Anderson 2002). Again, both response variables were log-transformed to meet the assumptions of the model. There was no effect of ambient temperature on either cruise or escape speed given that this variable was not included in any of the selected models. Thus, temperature was not considered in further analyses. For each

of the response variables, we tested the significance of the predictor variables for the most parsimonious model by running GLM analyses of the two models with the lowest AICc (Hurvich & Tsai 1989). To graphically display the results of each predictor in the final model, we used partial regression plots (Moya-Laraño & Corcobado 2008).

## Results

Our two estimates of locomotor performance were significantly repeatable. Repeatability values ( $R$ ) were very similar for both our presumed cruise and escape speeds.  $R_{\text{cruise speed}} = 0.436$  ( $n = 70$ ; 95%CI [0.332, 0.526];  $p < 0.001$ );  $R_{\text{escape speed}} = 0.462$  ( $n = 33$ ; 95%CI [0.182, 0.697];  $p < 0.001$ ). These two estimates of speed seemed to truly reflect cruise and escape speed respectively, as the latter was 8.3 times higher than the former (pair  $t$ -test:  $t_{69} = -35.036$ ,  $p < 0.001$ ; Fig. 2). Surprisingly, there was no correlation between cruise and escape speeds (estimate =  $-0.025 \pm 0.137$ ;  $t_{68} = -0.182$ ,  $p = 0.856$ ; Fig. 3).



**Figure 2.** Comparison between average cruise and escape speeds. The figure shows means and standard error bars.

**Figure 3.** Plots showing the relationship between escape speed and cruise speed. No correlation was found. Both variables were log-transformed.

The three most parsimonious models explaining escape speed according to the AICc criterion reflect the same pattern, showing that males in better body condition with shorter legs ran faster when escaping from a potential predatory threat (Table 1). Since the first and the second model are essentially the same, we will only comment the former. In the first model tibia length had a significant negative effect while body mass had a marginally significant positive effect on the response variable (Tibia length: estimate =  $-2.764 \pm 1.135$ ,  $t_{66} = -2.435$ ,  $p = 0.018$ , Fig. 4a; Body mass: estimate =  $1.651 \pm 0.849$ ,  $t_{66} = 1.945$ ,  $p = 0.056$ , Fig. 4b). In the third most parsimonious model tibia length again had a significant negative effect, while opisthosoma width had a marginally significant positive effect (Tibia length: estimate =  $-1.642 \pm 0.710$ ,  $t_{66} = -2.313$ ,  $p = 0.024$ ; Opisthosoma width: estimate =  $0.707 \pm 0.386$ ,  $t_{66} = 1.829$ ,  $p = 0.072$ ). Both models included the number of days in captivity before the performance trials, but this variable was not significant (both  $p > 0.08$ ).

**Table 1:** Model selection using the corrected Akaike's information criterion (AICc) to explain escape speed (log-transformed) ( $N = 70$ ).  $k$  refers to the number of parameters. Candidate models with  $\Delta\text{AICc} < 2$  are ranked according to their AICc. "**log\_cw**" log\_carapace width; "**log\_ow**" log\_opisthosoma width; "**log\_r3mass**" log\_cubic root of body mass; "**log\_ti1l**" log first tibia length; "**cdays**" number of captures days before performance trials. Bold letters show the selected models.

No.	Model	k	AICc	$\Delta\text{AICc}$	AICc weight
1.	<b>log_r3mass; log_ti1l; cdays</b>	5	<b>44.05</b>	<b>0</b>	<b>0.22%</b>
2.	<b>log_r3mass; log_ti1l</b>	4	<b>44.39</b>	<b>0.34</b>	<b>0.19%</b>
3.	<b>log_ow; log_ti1l; cdays</b>	5	<b>44.48</b>	<b>0.44</b>	<b>0.18%</b>
4.	log_r3mass; log_cw; cdays	5	45.10	1.06	0.13%
5.	log_r3mass; log_cw; log_ti1l; cdays	6	45.86	1.82	0.09%
6.	log_ow; log_ti1l	4	45.25	1.20	0.12%
7.	log_r3mass; log_ow; log_ti1l; cdays	6	46.04	2.00	0.08%

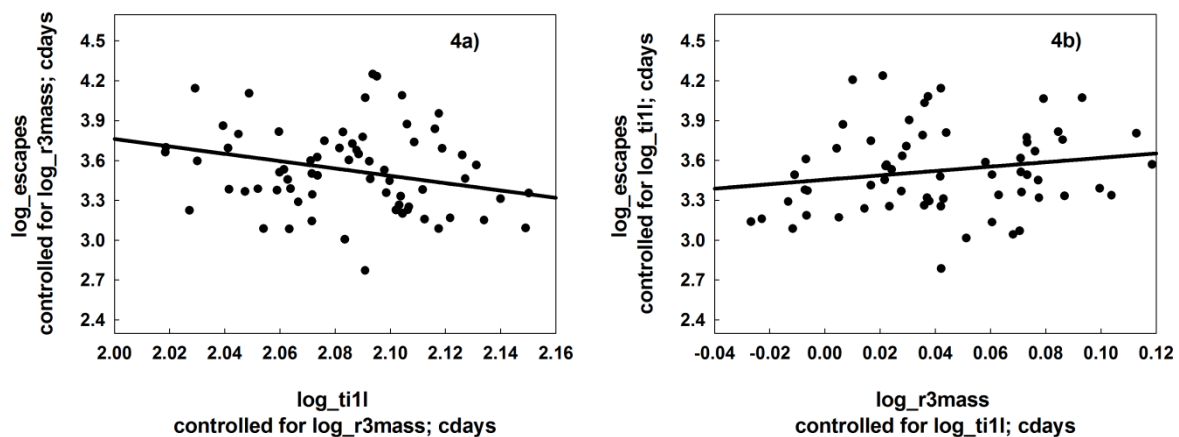
The two models for cruise speed with the lowest AICc show a similar pattern to that of escape speed. However, in this case, higher cruise velocity was exhibited by smaller males in better body condition (Table 2). In the first most parsimonious model opisthosoma width was positively related to cruise speed (estimate =  $1.151 \pm 0.456$ ,  $t_{67} = 2.525$ ,  $p = 0.014$ ), while carapace width was negatively related to this

response variable (estimate =  $-1.248 \pm 0.627$ ,  $t_{67} = -1.99$ ,  $p = 0.050$ ). In the second most parsimonious model, the predictor variables explaining cruise speed were carapace width and body mass, and in this case both variables were significant (Carapace width: estimate =  $-3.329 \pm 1.376$ ,  $t_{67} = -2.420$ ,  $p = 0.018$ , Fig. 5a; Body mass: estimate =  $3.309 \pm 1.370$ ,  $t_{67} = 2.415$ ,  $p = 0.018$ , Fig. 5b).

During the mating season in the wild, we found substantial and highly significant repeatability of body condition in males of *L. tarantula* ( $R_{\text{body condition}} = 0.717$   $n = 55$ ; 95%CI [0.569, 0.823];  $p < 0.001$ ).

**Table 2:** Model selection using corrected version of Akaike’s information criterion (AICc) to explain cruise speed (log-transformed) (N = 70). k refers to the number of parameters. Candidate models with  $\Delta\text{AICc} < 2$  are ranked according to their AICc. “**log\_cw**” log\_carapace width; “**log\_ow**” log\_opisthosoma width; “**log\_r3mass**” log\_cubic root of body mass; “**log\_ti11**” log first tibia length; “**log\_ti41**” log fourth tibia length. Bold letters show the selected models.

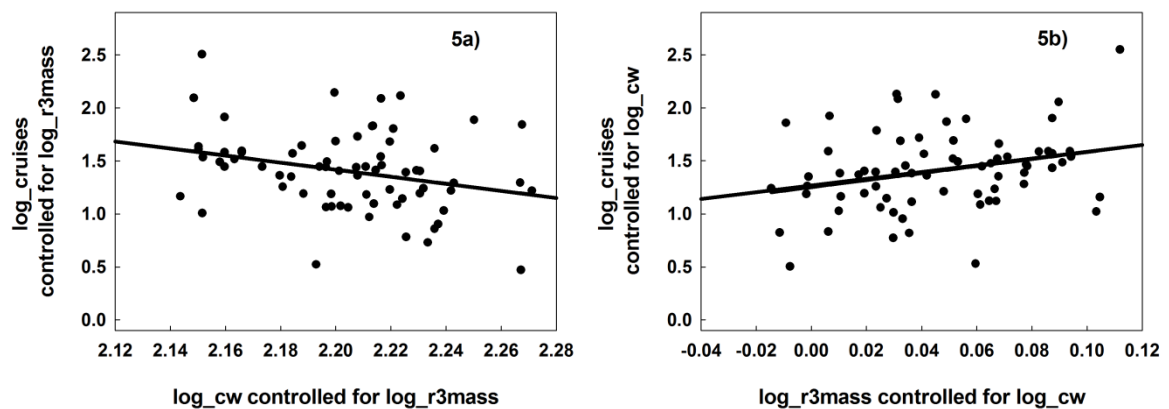
No.	Model	k	AICc	$\Delta\text{AICc}$	AICc weight
1.	<b>log_cw; log_ow</b>	4	<b>60.86</b>	<b>0</b>	<b>26%</b>
2.	<b>log_cw; log_r3mass</b>	4	<b>61.38</b>	<b>0.52</b>	<b>20.01%</b>
3.	log_cw; log_r3mass; log_ow	5	62.63	1.77	10.73%
4.	log_cw; log_ow; log_ti41	5	62.69	1.84	10.38%
5.	log_r3mass; log_ow	4	62.40	1.54	12.01%
6.	log_cw; log_ow; log_ti11	5	62.79	1.93	9.91%
7.	log_ow; log_ti41	4	62.58	1.73	10.97%



**Figure 4.** Partial regression plot between escape speed and tibia length (Fig. 4a) and body mass (Fig. 4b) respectively. **Fig. 4a:** Y axis log-transformed escape speed (log\_escapes) controlled for log-transformed cubic root of mass (log\_r3mass) and number of captured days before the performance trials (cdays); X axis shows log-transformed first tibia length (log\_ti11) controlled for log\_r3mass and cdays. **Fig. 4b:** Y axis shows log\_escapes controlled for log\_ti11 and cdays; X axis shows log\_r3mass controlled for log\_ti11 and cdays.

## Discussion

No correlation was found between cruise and escape speed. Thus, escape speed cannot be used to predict cruise speed, at least in our studied population of *L. tarantula*. If these results are confirmed in other systems, it will mean that the results obtained in studies based on escape or sprint speed cannot be extrapolated to other relevant contexts, such as mate search and sexual selection by scramble competition, where average or cruise speed should be more relevant than sprint speed (Husak & Fox 2008). Thus, all the previous studies trying to address evolutionary questions of extreme sexual size dimorphism (males much smaller than females) based on scramble competition (i.e. which male morphologies are more likely to find mates), which mostly used sprint speeds (eg. Brandt & Andrade 2007; Moya-Laraño et al. 2009; Prenter et al. 2010), should be treated with caution, as conclusions can only be drawn in the context of escaping from predators, and thus natural, not sexual selection (but see Corcobado et al. 2010 *manuscript III of this thesis*). Also, when exploring the morphological determinants of performance, we found different explanatory variables predicting these two types of locomotion. While a good body condition is relevant for both cruise and escape speed, smaller males (size measured as carapace width) had an advantage in cruise speed, while males with shorter legs seemed better at escaping from predators.



**Figure 5.** Partial regression plot between cruise speed and carapace width (Fig. 5a) and body mass (Fig. 5b) respectively. **Fig. 5a:** Y axis shows log-transformed cruise speed ( $\log_{\text{cruises}}$ ) controlled for log-transformed

cubic root of mass ( $\log_{r3mass}$ ); X axis shows log-transformed carapace width ( $\log_{cw}$ ) controlled for  $\log_{r3mass}$ . **Fig. 5b:** Y axis shows  $\log_{cruises}$  controlled for  $\log_{cw}$ ; X axis shows  $\log_{r3mass}$  controlled for  $\log_{cw}$ .

We did not find a trade-off between cruise and escape speed in males of *L. tarantula*. Nevertheless, as far as we know, there are no previous studies that have explored the correspondence between sprint and cruise speed as we have done in this research. More research is necessary to explore the possible morphological and physiological determinants and constraints of cruise vs. escape speed across different taxa and to ascertain whether our findings are verified through inter and intra-specific studies. The relationship between cruise endurance and escape endurance, and cruise and escape speeds should be considered as well.

### ***The mechanics of inverted pendulums***

Focussing in which fix characters were significantly related to locomotor performance, and consistently with the mechanics of inverted pendulums (Manton 1977; Alexander 1982; Moya-Laraño et al. 2008b *manuscript 1 of this thesis*), we found that males with shorter legs ran faster when trying to escape from potential predators. Unfortunately, it is not possible to compare this pattern with previous studies, because the majority of the previous research showing that longer limbs are related to higher sprint speed focused on lizards (Losos 1990; Husak et al. 2006; Calsbeek & Irschick 2007), which are anatomically and physiologically very different from spiders. However, it should be always true that leg length favours step (stride) length and thus speed, while it interferes with efficient mass lifting at each step (inverted pendulum mechanics). Thus, we should expect to find one or another relationship (or even an optimal intermediate leg length) depending on the range of leg lengths present in the different populations of each species, and how much mass these legs have to lift at each step. Using a similar methodology to that of us, Pruitt et al. (Pruitt 2010) studied escape speed in two spider species of the family Lycosidae and two others in the Agelenidae, and they found no relationship between body size and sprint speed in any of the four species, but, consistently with the mechanics of inverted pendulums, they found an effect of leg length on the reduction of sprint speed after *ad-libitum* feeding (thus when individuals carry a heavy load) in the two Agelenidae species. In a very original hypothesis, Framenau (Framenau 2005)



argued that males with very long legs could compensate the loss of force by reducing their own mass, which could be a source of selection for smaller males. For this hypothesis to hold one would have to find that males with longer legs and lower masses do run faster. However, for at least sprint speed, we found the opposite pattern; that heavier males with shorter legs ran faster. Nevertheless, a recent study in an insect supports Framenau's hypothesis; using the giant weta (Orthoptera: Anostostomatidae), a species showing the normal pattern for ectotherms of females larger than males, Kelly and collaborators (Kelly et al. 2008) showed through path analysis that smaller males with longer legs had higher mobility, and that more mobile males had greater insemination success.

Our results on body condition, however, run counter with the prediction of inverted pendulum mechanics, as males carrying heavier loads were faster in the two performance contexts. These results are better explained if we consider body condition to be a quality-dependent handicap (Zahavi 1975; Grafen 1990).

### ***Body condition as a quality-dependent handicap***

In this population of *L. tarantula*, females generally prefer to mate with males in better condition and cannibalize males in poor condition (Rabaneda-Bueno R, Aguado-de-la-Paz S, Fernández-Montraveta C and Moya-Laraño J, *unpublished data*). Because *L. tarantula* males provide no paternal care, female mate choice must pursue high genetic quality for their offspring (e.g. Hansen & Price 1995 and reference therein). Our suggestion is that females choose males in better body condition because it is an honest signal of male genetic quality. The reliability of the signal would be ensured by its cost (Zahavi 1975): according to biomechanical models, the mobility of ground-dwelling spiders should decrease with their body condition (Moya-Laraño et al. 2008b). There are three lines of evidence suggesting that males in good body condition have high genetic quality. (1) Males in good body condition had higher cruise and escape speeds, despite the fact that they had to develop more power than males in poor condition to achieve even the same speed. Males in good condition are therefore sufficiently strong to carry their extra-heavy loads around. (2) Given that the amount of food ingested by juvenile males affects body condition (mass controlled for carapace width) at maturation (Fernandez-

Montraveta & Moya-Laraño 2007; Moya-Laraño et al. 2008a), adult body condition is costly and could be considered to reflect the genetic ability to capture prey. Finally, (3) in the wild, male body condition remained relatively constant over the mating season, suggesting that males regulate their body condition (e.g. by feeding during the mating season, G. Cordobado and S. Aguado-de-la-Paz *personal observations*) and that body condition may have a quantitative genetic component (Lynch & Walsh 1998 but see Naya 2010). Thus, females may be choosing high quality males based on male body condition, which could be easily assess from their abdominal body markings (Moya-Laraño et al. 2003c). Thus, by choosing males in better condition, females could accrue indirect genetic benefits, as for instance, having male offspring which would be better escapers and scramblers.

### ***Are smaller males better scramblers?***

We found that smaller males were faster cruisers, which suggest an advantage of small size for males during mate searching, since males with higher cruise speed would reach mates first or alternatively would have access to a higher number of receptive females. However, a Principal Components Analysis with Varimax rotation shows that carapace width and leg length are strongly collinear, as both traits load heavily ( $>0.90$ ) in PC1 (not shown). Thus, this suggests that smaller males may be at a scramble advantage also because they have shorter legs (see above). Alternatively, small males may move their legs at a higher frequency, allowing faster movement (Moya-Laraño et al. 2009). Contrary, Brand et al. (Brandt & Andrade 2007) showed that larger *Latrodectus hesperus* males ran faster, and proposed that larger males, instead, would have an advantage at scramble competition. Although these authors measured maximal sprint speed rather than cruise speed –which is arguably more relevant for mate searching–, in a more northern population of *L. tarantula* (Moya-Laraño et al. 2003a), larger males (carapace width) showed an advantage, as they were found to visit more females in the wild (Fernandez-Montraveta & Moya-Laraño 2007), suggesting that in this population mobility increases with male size. These two studies have something in common: in both cases, males were smaller than those used for our study. Males in the northern population of *L. tarantula* were 8% smaller than the males of the

present population (the males found in Cabo de Gata are among the largest known for the species and the genus in the Iberian Peninsula; (Fernandez-Montraveta & Moya-Laraño 2007), while *Latrodectus* males are tiny compared to adult *L. tarantula* males. It is therefore possible that for relatively small males the positive effect of size on step length is more important than the negative effect of an increased torque (Moya-Laraño et al. 2008b), leading to a positive relationship between size and speed at small sizes. Alternatively, large males may be observed with more females because they enjoy an advantage over smaller males in male-male combats (Andersson 1994). However, this is unlikely as in another population, previous residence, but not size, has been found to affect which male wins a combat after exposure to female cues (Fernandez-Montraveta & Ortega 1993). Finally, although our data do not enable us to definitively elucidate the question of whether sexual selection by scramble competition directly acts on cruise speed, they provide very interesting results in favour of this idea and lead us to emphasize the importance of including this variable in studies of locomotor performance in relation to sexual selection by scramble competition.

## Aknowledgments

We thank S. Aguado-De-La-Paz who helped to capture and weigh spiders. This ms has been written under a pre-doctoral grant (FPI; ref: BES-2005-9234) from the Spanish Ministry of Science and Education (MEC)/FEDER to GC. This research has been partially funded by two MEC/FEDER grants (CGL2004-03153 and CGL2007-60520) to JM-L.

## References

- Akaike, H. 1987. Factor-Analysis and Aic. *Psychometrika* 52, 317-332.
- Alexander, R.M. 1982. Size, shape and structure for running and flying. In: *Companion to Animal Physiology* (Ed. by C.R.Taylor, V.Johanson & L.Bolis), pp. 309-324. Cambridge, Cambridge University Press.
- Andersson, M. 1994. *Sexual Selection*. Princeton, NJ.: Princeton University Press.
- Bauwens, D., Garland, T., Castilla, A.M. & Vandamme, R. 1995. Evolution of Sprint Speed in Lacertid Lizards - Morphological, Physiological, and Behavioral Covariation. *Evolution* 49, 848-863.
- Berwaerts, K., Aerts, P. & Van Dyck, H. 2006. On the sex-specific mechanisms of butterfly flight: flight performance relative to flight morphology, wing kinematics, and sex in *Pararge aegeria*. *Biological Journal of the Linnean Society* 89, 675-687.
- Biedermann, R. 2002. Mating success in the spittlebug *Cercopis sanguinolenta* (Scopoli, 1763) (Homoptera, Cercopidae): the role of body size and mobility. *Journal of Ethology* 20, 13-18.
- Billerbeck, J.M., Lankford, T.E. & Conover, D.O. 2001. Evolution of intrinsic growth and energy acquisition rates. I. Trade-offs with swimming performance in *Menidia menidia*. *Evolution* 55, 1863-1872.
- Brandt, Y. & Andrade, M.C.B. 2007. Testing the gravity hypothesis of sexual size dimorphism: are small males faster climbers? *Functional Ecology* 21, 379-385.
- Burnham, K.P. & Anderson, D.R. 2002. *Model Selection and Multimodel Inference: a Practical Information-Theoretic Approach*. New York: Springer.
- Calsbeek, R. 2008. An ecological twist on the morphology-performance-fitness axis. *Evolutionary Ecology Research* 10, 197-212.
- Calsbeek, R. & Irschick, D.J. 2007. The quick and the dead: Correlational selection on morphology, performance, and habitat use in island lizards. *Evolution* 61, 2493-2503.
- Corcobado, G., Rodriguez-Girones, M.A., De Mas, E. & Moya-Laraño, J. 2010. Introducing the refined gravity hypothesis of extreme sexual size dimorphism. *Bmc Evolutionary Biology* 10, 236.
- Cotton, S., Small, J. & Pomiankowski, A. 2006. Sexual selection and condition-dependent mate preferences. *Current Biology* 16, R755-R765.

- De Mas,E., Ribera,C. & Moya-Laraño,J. 2009. Resurrecting the differential mortality model of sexual size dimorphism. *Journal of Evolutionary Biology* 22, 1739-1749.
- Fernandez-Montraveta,C. & Ortega,J. 1993. Sex differences in the agonistic behaviour of a lycosid spider (Araneae Lycosidae). *Ethology Ecology & Evolution* 5, 293-301.
- Fernandez-Montraveta,C. & Moya-Laraño,J. 2007. Sex-specific plasticity of growth and maturation size in a spider: implications for sexual size dimorphism. *Journal of Evolutionary Biology* 20, 1689-1699.
- Fish,F.E. & Nicastro,A.J. 2003. Aquatic turning performance by the whirligig beetle: constraints on maneuverability by a rigid biological system. *Journal of Experimental Biology* 206, 1649-1656.
- Foellmer,M.W. & Fairbairn,D.J. 2005. Selection on male size, leg length and condition during mate search in a sexually highly dimorphic orb-weaving spider. *Oecologia* 142, 653-662.
- Foellmer,M.W. & Moya-Laraño,J. 2007. Sexual Size Dimorphism in Spiders. In: *Sex, Size & Gender Roles. Evolutionary Studies of Sexual Size Dimorphism* (Ed. by D.J.Fairbairn, W.U.Blanckenhorn & T.Szekely), pp. 71-81. New York, Oxford University Press.
- Framenau,V.W. 2005. Gender specific differences in activity and home range reflect morphological dimorphism in wolf spiders (Araneae, Lycosidae). *Journal of Arachnology* 33, 334-346.
- Garland,T.Jr. & Freeman,P.W. 2005. Selective breeding for high endurance running increases hindlimb symmetry. *Evolution* 59, 1851-1854.
- Grafen,A. 1990. Biological Signals As Handicaps. *Journal of Theoretical Biology* 144, 517-546.
- Hansen,T.F. & Price,D.K. 1995. Good genes and old age: Do old mates provide superior genes? *Journal of Evolutionary Biology* 8, 759-778.
- Hebets,E.A., Wesson,J. & Shamble,P.S. 2008. Diet influences mate choice selectivity in adult female wolf spiders. *Animal Behaviour* 76, 355-363.
- Hurvich,C.M. & Tsai,C.L. 1989. Regression and Time-Series Model Selection in Small Samples. *Biometrika* 76, 297-307.
- Husak,J.F. 2006. Does survival depend on how fast you can run or how fast you do run? *Functional Ecology* 20, 1080-1086.
- Husak,J.F., Fox,S.F., Lovern,M.B. & Van Den Bussche,R.A. 2006. Faster lizards sire more offspring: Sexual selection on whole-animal performance. *Evolution* 60, 2122-2130.

- Husak,J.F. & Fox,S.F. 2006. Field use of maximal sprint speed by collared lizards (*Crotaphytus collaris*): Compensation and sexual selection. *Evolution* 60, 1888-1895.
- Husak,J.F. & Fox,S.F. 2008. Sexual selection on locomotor performance. *Evolutionary Ecology Research* 10, 213-228.
- Husak,J.F., Fox,S.F. & Van Den Bussche,R.A. 2008. Faster male lizards are better defenders not sneakers. *Animal Behaviour* 75, 1725-1730.
- Iriarte-Diaz,J. 2002. Differential scaling of locomotor performance in small and large terrestrial mammals. *Journal of Experimental Biology* 205, 2897-2908.
- Irschick,D.J., Meyers,J.J., Husak,J.F. & Le Galliard,J.F. 2008. How does selection operate on whole-organism functional performance capacities? A review and synthesis. *Evolutionary Ecology Research* 10, 177-196.
- Jakob,E.M., Marshall,S.D. & Uetz,G.W. 1996. Estimating fitness: A comparison of body condition indices. *Oikos* 77, 61-67.
- Jayne,B.C. & Bennett,A.F. 1990. Selection on Locomotor Performance Capacity in A Natural-Population of Garter Snakes. *Evolution* 44, 1204-1229.
- Johansson,F., Lederer,B. & Lind,M.I. 2010. Trait Performance Correlations across Life Stages under Environmental Stress Conditions in the Common Frog, *Rana temporaria*. *PLoS ONE* 5.
- Kelly,C.D., Bussiere,L.F. & Gwynne,D.T. 2008. Sexual selection for male mobility in a giant insect with female-biased size dimorphism. *American Naturalist* 172, 417-423.
- Lande,R. 1982. A Quantitative Genetic Theory of Life-History Evolution. *Ecology* 63, 607-615.
- Lessells,C.M. & Boag,P.T. 1987. Unrepeatable repeatabilities: A common mistake. *The Auk* 104, 116-121.
- Losos,J.B. 1990. Ecomorphology, Performance Capability, and Scaling of West-Indian Anolis Lizards - An Evolutionary Analysis. *Ecological Monographs* 60, 369-388.
- Lynch,M. & Walsh,B. 1998. *Genetics and Analysis of Quantitative Traits*. Sunderland, MA.: Sinauer Associates.
- Manton,S.M. 1977. *The Arthropoda. Habits, Functional Morphology, and Evolution*. Oxford: Clarendon Press.
- Miles,D.B. 2004. The race goes to the swift: fitness consequences of variation in sprint performance in juvenile lizards. *Evolutionary Ecology Research* 6, 63-75.

- Moya-Laraño, J. 1999. Limitación Por El Alimento, Territorialidad y Canibalismo En La Tarántula Mediterránea, *Lycosa Tarentula* (L.) (Araneae, Lycosidae). Autonomous University of Barcelona.
- Moya-Laraño, J., Orta-Ocana, J.M., Antonio Barrientos, J., Bach, C. & Wise, D.H. 2002a. Territoriality in a cannibalistic burrowing wolf spider. *Ecology (Washington D C)* 83.
- Moya-Laraño, J., Halaj, J. & Wise, D.H. 2002b. Climbing to reach females: Romeo should be small. *Evolution* 56, 420-425.
- Moya-Laraño, J., Orta-Ocana, J.M., Barrientos, J.A., Bach, C. & Wise, D.H. 2003a. Intriguing compensation by adult female spiders for food limitation experienced as juveniles. *Oikos* 101, 539-548.
- Moya-Laraño, J., Pascual, J. & Wise, D.H. 2003b. Mating patterns in late-maturing female Mediterranean tarantulas may reflect the costs and benefits of sexual cannibalism. *Animal Behaviour* 66, 469-476.
- Moya-Laraño, J., Taylor, P.W. & Fernández-Montraveta, C. 2003c. Body patterns as potential amplifiers of size and condition in a territorial spider. *Biological Journal of the Linnean Society* 78, 355-364.
- Moya-Laraño, J., Pascual, J. & Wise, D.H. 2004. Approach strategy by which male Mediterranean tarantulas adjust to the cannibalistic behaviour of females. *Ethology* 110, 717-724.
- Moya-Laraño, J., El Sayyid, M.E.T. & Fox, C.W. 2007. Smaller beetles are better scramble competitors at cooler temperatures. *Biology Letters* 3, 475-478.
- Moya-Laraño, J. & Corcobado, G. 2008. Plotting partial correlation and regression in ecological studies. *Web Ecology* 8, 35-46.
- Moya-Laraño, J., Macias-Ordonez, R., Blanckenhorn, W.U. & Fernandez-Montraveta, C. 2008a. Analysing body condition: mass, volume or density? *Journal of Animal Ecology* 77, 1099-1108.
- Moya-Laraño, J., Vinkovic, D., De Mas, E., Corcobado, G. & Moreno, E. 2008b. Morphological Evolution of Spiders Predicted by Pendulum Mechanics. *PLoS ONE* 3.
- Moya-Laraño, J., Vinkovic, D., Allard, C.M. & Foellmer, M.W. 2009. Optimal climbing speed explains the evolution of extreme sexual size dimorphism in spiders. *J. Evol. Biol.* 22, 954-963.
- Nakagawa, S. & Schielzeth, H. 2010. Repeatability for Gaussian and non-Gaussian data: a practical guide for biologists. *Biological Reviews* 85, 935-956.
- Naya, D.E. 2010. Why may repeatability of highly flexible traits say little about their evolutionary potential? *The Open Ecology Journal* 3, 26-28.

- Prenter, J., Perez-Staples, D. & Taylor, P.W. 2010. The effects of morphology and substrate diameter on climbing and locomotor performance in male spiders. *Functional Ecology* 24, 400-408.
- Prestwich, K.N. 1983. The Roles of Aerobic and Anaerobic Metabolism in Active Spiders. *Physiological Zoology* 56, 122-132.
- Pruitt, J.N. 2010. Differential selection on sprint speed and ad libitum feeding behaviour in active vs. sit-and-wait foraging spiders. *Functional Ecology* 24, 392-399.
- Pruitt, J.N. & Husak, J.F. 2010. Context-dependent running speed in funnel-web spiders from divergent populations. *Functional Ecology* 24, 165-171.
- Rabameda-Bueno, R., Rodriguez-Girones, M.A., Aguado-de-la-Paz, S., Fernández-Montraveta, C., De Mas, E., Wise, D.H. & Moya-Laraño, J. 2008. Sexual cannibalism: high incidence in a natural population with benefits to females. *PLoS ONE* 3, e3484.
- Zahavi, A. 1975. Mate Selection - Selection for A Handicap. *Journal of Theoretical Biology* 53, 205-214.



# MANUSCRIPT VI

## Scamble competition by male long-distance mobility in a burrowing wolf spider

Guadalupe Corcobado<sup>1\*</sup>, Miguel A. Rodríguez-Gironés<sup>1</sup>, Sara Aguado-de-la-Paz<sup>2</sup>

Jordi Moya-Laraño<sup>1</sup>

<sup>1</sup>Dpto. de Ecología Funcional y Evolutiva, Estación Experimental de Zonas Áridas, CSIC, Carretera de Sacramento, s/n. La Cañada de San Urbano, C.P. 04120. Almería, Spain.

<sup>2</sup>Dpto. Biología de Organismos y Sistemas, Universidad de Oviedo, c/ Catedrático Rodrigo Uría, s/n, E-33071 Oviedo, Spain.



## Resumen

A pesar del gran número de estudio sobre selección sexual, existen sesgos importantes, dat que se ha prestado muy poca atención a la selección sexual por orden de llegada, la cual favorecería a los machos más ágiles y/o a los más móviles que serían los que primero localizarían hembras receptivas. Se espera que la competencia por orden de llegada sea más relevante en sistemas reproductivos poligínicos con una distribución esparcida de hembras y una baja densidad de machos. Algunas hipótesis han relacionado la competencia por orden de llegada a la evolución del dimorfismo sexual en el tamaño (SSD) extreme sesgado hacia las hembras, pero apenas hay datos acerca de especies con moderado o no existente SSD. Se realizó un experimento para estudiar la competencia por orden de llegada en una araña lobo excavadora de nidos, la tarantula mediterránea (*Lycosa tarantula*, Lycosidae, Araneae), una especie que exhibe moderado SSD sesgado hacia las hembras en condiciones naturales. Se midió la movilidad de los machos usando la técnica de captura-recaptura y se evaluó la selección natural durante la búsqueda de pareja por medio de calcular gradientes de selección sobre el tamaño, la condición corporal y la movilidad. Se encontró que los machos de *L. tarantula* eran extraordinariamente móviles, mostrando una velocidad promedio de  $4.12 \pm 3.84 \text{ m}\cdot\text{h}^{-1}$  lo cual implicaría una distancia media de aproximadamente 33 m por noche. Hubo una relación positive entre condición corporal y velocidad promedio, resultado que está de acuerdo con la idea propuesta recientemente de la condición corporal actuando como un *handicap* dependiente de la calidad. Los gradientes de selección lineares evidenciaron selección direccional sobre condición corporal y movilidad, siendo la selección sobre la movilidad mucho más fuerte que sobre la condición. Así, la condición corporal tuvo un efecto doble sobre la eficacia biológica: un efecto indirecto causado por su relación con la velocidad media, la cual a su vez está relacionada con un mayor éxito de apareamiento, y además un efecto directo (gradiente de selección direccional positive tras controlar por la movilidad) el cual probablemente refleje el hecho de que las hembras prefieren aparearse con machos en mejor condición. Los resultados de este trabajo ponen de manifiesto la importancia de evaluar la competencia por orden de llegada en la naturaleza, dado que puede desempeñar un papel relevante no solo en especies con un patrón de SSD extreme tal como se había propuesto, sino que también en especies caracterizadas por un SSD moderado, tales como la tarantula mediterránea estudiada en este trabajo.

**Palabras clave:** búsqueda de pareja, condición corporal, gradientes de selección, *Lycosa tarantula*, velocidad de crucero

## Abstract

Despite the large number of studies on sexual selection, some important biases exist, as the little attention paid to intra-sexual selection by scramble competition, which would favour more agile and/or mobile males who would locate receptive females first. Scramble competition is expected to be more relevant in polygynous reproductive systems with scattered distributions of females and low male densities. Some hypotheses have related scramble competition to the evolution of extreme female-biased SSD, but there is almost no data about species with moderate or non-existent SSD. Here, we carried out an experiment to study scramble competition in a burrowing wolf spider, the Mediterranean tarantula (*Lycosa tarantula*, Lycosidae, Araneae), a species exhibiting moderate female-biased SSD, in natural conditions. We measured male mobility using the mark-recapture technique and we evaluated natural selection during mate searching by calculating selection gradients on body size, body condition and mobility. We found that males of *L. tarantula* were extraordinarily mobile, showing an average speed of  $4.12 \pm 3.84 \text{ m} \cdot \text{h}^{-1}$  which would imply a mean distance of approximately 33 m per night. There was a positive relationship between body condition and average speed, which is in agreement with the recently proposed idea of body condition acting as a quality-dependent handicap. Linear selection gradients revealed evidence of directional selection on body condition and mobility, being selection on mobility stronger than on condition. Thus, body condition had a double effect on fitness: an indirect effect caused by its relationship with average speed which in turn is related to higher mating success, and also a direct effect (positive directional selection gradient after controlling for mobility) which likely reflects the fact that females choose to mate with males in better condition. The results of this work highlight the importance of evaluating scramble competition in nature, given that it may play a relevant role not only in species exhibiting extreme SSD as it has been proposed, but also in species with moderate SSD, as the Mediterranean tarantula studied here.

**Keywords:** body condition, cruise speed, *Lycosa tarantula*, mate searching, mobility, selection gradients

## Introduction

Even though sexual selection has been intensively studied (Andersson 1994) ever since Darwin (Darwin 1871) proposed his theory to explain the observed patterns of sexual size dimorphism (SSD), some important questions remain as yet unsolved (Shuster & Wade 2003). In particular, little attention has been paid to intra-sexual selection by scramble competition (i.e. selection for locating females first), even though it is generally accepted that it can promote the evolution of more agile and/or mobile males (Thornhill & Alcock 1983; Schwagmeyer 1988; Able 1999; Legrand & Morse 2000; Moya-Laraño et al. 2002b; Kelly et al. 2008). Moreover, there is an important bias in the study of natural and sexual selection, as most of the studies evaluate selection on morphological traits while neglecting selection on behaviour or functional capacities (reviewed in Irschick et al. 2008).

Scramble competition is expected to be more relevant in polygynous reproductive systems with scattered distributions of females and low densities of males; i.e., those systems in which the probability of encounter between individuals is minimum (reviewed in Andersson 1994). The importance of scramble competition has been documented in different taxa, including mammals (Schwagmeyer 1988), birds (Raihani et al. 2006), amphibians (Able 1999), insects (Hanks et al. 1996a; Moya-Laraño et al. 2007; Kelly et al. 2008) or spiders (Legrand & Morse 2000; Foellmer & Fairbairn 2005). Nevertheless, very few studies have monitored sexual selection by scramble competition in the wild (Schwagmeyer 1988; Hanks et al. 1996b; Able 1999; Foellmer & Fairbairn 2005; Kelly et al. 2008).

Among spiders, males are generally the searching sex and in many species adult females are sedentary (Foelix 1996; but see Aisenberg et al. 2007; De Mas et al. 2009), the spatial distribution of receptive females is generally scattered (e.g. (Fernandez-Montraveta et al. 1991) and a polygynous reproductive system could be the most common pattern (Foelix 1996). As a result, spiders constitute an excellent system to study sexual selection by scramble competition. Indeed, it has been proposed that selection through scramble competition could be one of the factors favouring the evolution of extreme female-biased SSD among spiders (Moya-Laraño

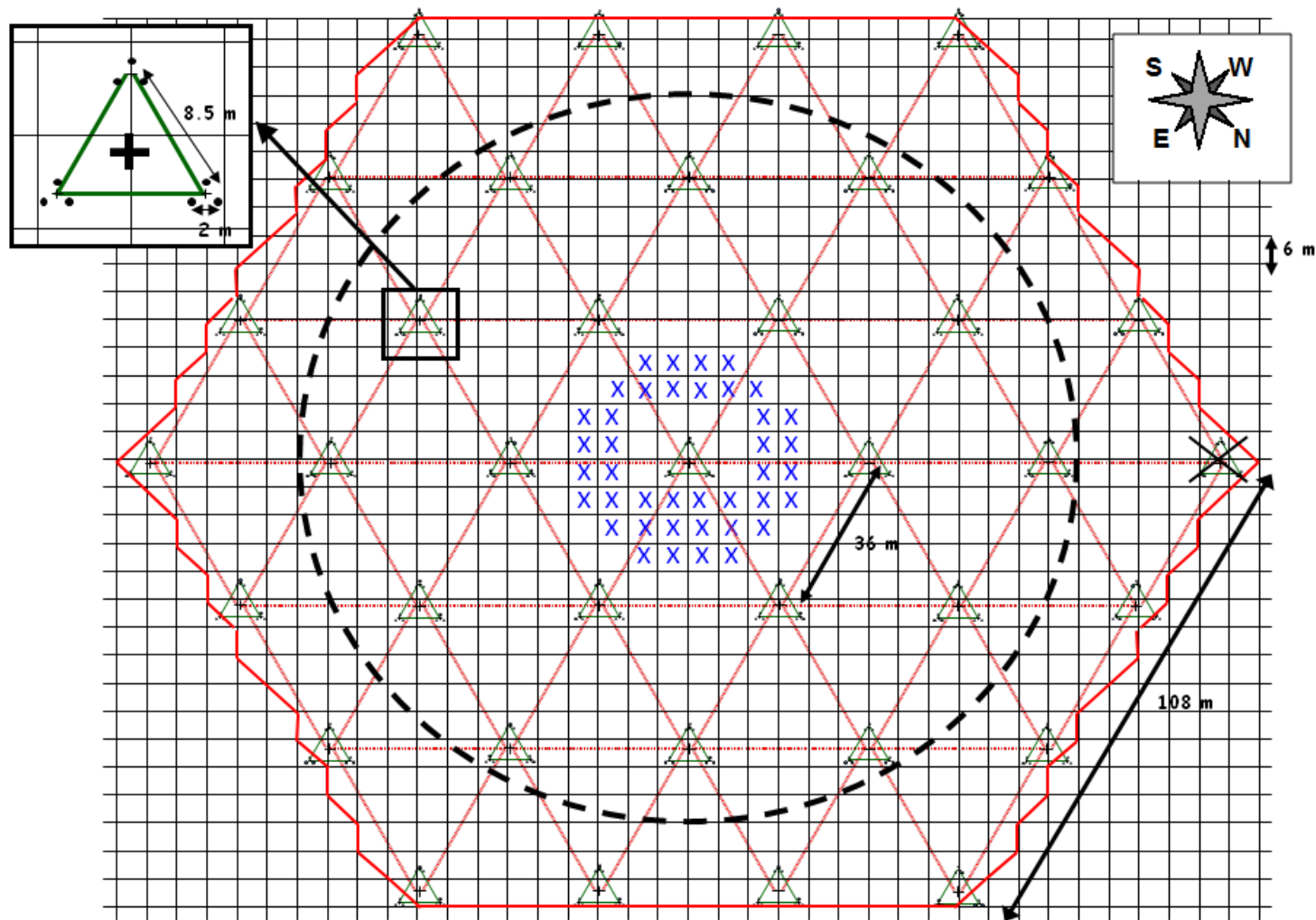
et al. 2002b; Foellmer & Moya-Laraño 2007; Moya-Laraño et al. 2009; Corcobado et al. 2010), and there is morphological evidence of selection by scramble competition in a natural population of orb-spiders with extreme female-biased SSD (Foellmer & Fairbairn 2005), although direct measurements of spider mobility are still lacking in this context. On the other hand, as far as we know only one previous study, showing that larger males visited more females (Fernandez-Montraveta & Moya-Laraño 2007), suggests a role for scramble competition in spiders with moderate female-biased SSD. So, it is much less clear whether, in spiders where males are only slightly smaller than females, scramble competition plays a relevant role or is much weaker than other mechanisms such as direct male-male combat.

Locomotor performance is tightly related to scramble competition. Unfortunately, most studies of locomotor performance in spiders have measured maximum speed in the context of escaping from predators (Moya-Laraño et al. 2002b; Brandt & Andrade 2007; Moya-Laraño et al. 2008; Moya-Laraño et al. 2009; Prenter et al. 2010) while cruise speed, which has been rarely evaluated, is expected to be much more relevant during mate searching. In addition, it has been shown that there is no correlation between sprint and cruise speed (G. Corcobado, M.A. Rodríguez-Gironés & J. Moya-Laraño *chapter V of this thesis*). In the above study, using field enclosures to measure cruise speed in males of *Lycosa tarantula* (L.), we found that smaller individuals in better condition had higher cruise speeds. With a mark-recapture study, Kotiaho *et al* (Kotiaho et al. 1999) found that heavier males of the wolf spider *Hygrolycosa rubrofasciata* moved larger distances, suggesting that these heavier males would have an advantage during the mate-searching activity. However, given that in spiders body mass is correlated both with body size and body condition (e.g., Foellmer & Moya-Laraño 2007), it is unclear whether the *H. rubrofasciata* males which moved larger distances had greater body size or were in better condition.

In this study we use the Mediterranean tarantula (*L. tarantula*), a burrowing wolf spider characterized by a moderate female-biased SSD, as a model to evaluate the importance of scramble competition in the field. Several lines of indirect evidence suggest that scramble competition can play a relevant role in wild populations of *L. tarantula*. First, in the laboratory, previous residence rather than body size determined the fate of male-male combats (Fernandez-Montraveta &

Ortega 1993), highlighting the importance of being the first to reach a female. Second, mating with virgin females is more likely to occur after a long than a short period of cohabitation (Fernandez-Montraveta & Cuadrado 2003a; Moya-Laraño et al. 2003b), once again giving an advantage to males which reached females earlier, even in their subadult stage (Fernandez-Montraveta & Cuadrado 2003a). Third, because in this species males use contact pheromones (Fernandez-Montraveta & Ruano-Bellido 2000) instead of long-distance airborne chemical cues to locate females (Fernandez-Montraveta & Cuadrado 2009), more mobile males would be able to explore greater surfaces, having a higher chance to find receptive females. More mobile males are not only likely to be the first to reach virgin females: they can also find more potential mates. *L. tarantula* females may mate up to three times (Moya-Laraño et al. 2003b; Rabaneda-Bueno et al. 2008), and non-virgin females normally mate without long cohabitation periods –although non-virgin females are also more prone to attack and consume approaching males (Rabaneda-Bueno et al. 2008).

Although available data suggest that scramble competition can play an important role in the mating success of *L. tarantula* males, direct evidence is missing. In order to evaluate scramble competition in the field in a natural population of *L. tarantula*, we described movement patterns in males of this species, and measured gradients of selection on male body size, male body condition and mobility (i.e. cruise speed) during mate searching. Given that cruise speed measured in field enclosures was negatively related to body size and positively related to body condition in this species (G. Corcobado, M.A. Rodríguez-Gironés & J. Moya-Laraño *chapter V of this thesis*) we expected to verify this same pattern in natural conditions and consequently, (i) we predicted that average speed was negatively correlated with body size and positively correlated with body condition during mate searching in males of *L. tarantula*. The results from field enclosures, together with the evidence that females preferentially mate with males in better condition, killing and consuming males in worse condition (R. Rabaneda-Bueno, S. Aguado-de-la-Paz, C. Fernández-Montraveta & J. Moya-Laraño *unpublished data*), lead us to predicted (ii) positive selection on male body condition and (iii) negative selection on male body size. Finally, (iv) we predicted positive selection for more mobile males –i.e. males with higher average cruise speed– during mate searching.



**Figure 1: Scheme of the experimental plot.** We established a regular distribution of artificial burrows in a 3 ha plot distributed along a hexagonal lattice, in which three natural spatial scales were embedded forming groups of equilateral triangles of 2 m, 8.5 m and 36 m in side. The dashed lined circumference delimited the central triangles whose burrows were monitored for matings. The outer part of this circumference corresponds to the control exterior ring, which was set up to minimize edge effects. Blue crosses show the grids where males were released each week. See text for more details.

## Material and Methods

### Study system

*L. tarantula* is a burrowing wolf spider which inhabits Mediterranean semi-arid environments. Subadult males and females share the same lifestyle spending most of the time inside their burrows, which they leave only during the night to capture prey in the area surrounding their refuges (Moya-Laraño 1999). At maturation, males abandon their burrows and become errant searching for females, mostly during the night. Once they find a potential mate, they can cohabit with her for several days until they finally mate, generally during the day inside the female's burrow (Fernandez-Montraveta & Cuadrado 2003a; Moya-Laraño et al. 2003b; Moya-Laraño et al. 2004). We conducted our study in Cabo de Gata (36° 48' N, 02°08'W), Almería, SE Spain during the 2007 mating season of *L. tarantula*. In this area, the mating season varies among years but usually peaks late in June or early in July and ends by August (e.g. (Moya-Laraño et al. 2002a; Moya-Laraño et al. 2003b; Rabaneda-Bueno et al. 2008).

### Experimental design

We set up a regular distribution of artificial burrows (Moya-Laraño et al. 2002a) at three different scales in a 3 ha plot from which we had previously removed all resident *L. tarantula*. Experimental burrows were distributed along a hexagonal lattice, in which the three natural spatial scales were embedded as follows. At the smallest scale, burrows formed equilateral triangles 2 m in side. At the intermediate scale, the centre of each three-burrow cluster was at the vertex of another equilateral triangle, 8.5 m in side. Finally, the centre of each of these nine-burrow clusters was at the vertex of a large equilateral triangle, 36 m in side. Overall, the experimental field included 324 burrows distributed on a regular hexagon of 108 m in side covering a total area of approximately 3 ha (one 9-burrow cluster could not be constructed, see below). To minimize edge effects, the outermost nine-burrow clusters were used as a buffer zone: we did not control



mating in these nests. The core area, which was monitored as explained below, included 171 nests –i.e. 19 nine-burrow. Note that there was a gap in the edge of nests in NW extreme of the hexagon because the existence of old ruins did not enable us to build the correspondent burrows in this location.

The hexagonal lattice of burrows was superposed on a 6 m square grid of sticks, labelled with the names of the “row” –i.e SE-NW orientation– and “column” – i.e. SW-NE orientation– to which each stick belonged. This grid allowed us to determine the spatial location of any point in the study area with a resolution of 6 m (Fig. 1). Furthermore, the rows of the grid served as transects when we surveyed the plot for males (see below). We collected subadult and adult females in the surrounding areas and introduced them inside the artificial burrows. Each female was randomly assigned to a particular nest. By including both subadult and adult females in similar proportions to surrounding areas we were able to follow the natural progress of the mating season; i.e., females were maturing and mating progressively at the normal pace of the mating season. During the study the burrows suffered a high predation rate caused by scorpions and foxes (*Vulpes vulpes*), both well-known predators of this species (Moya-Laraño 2002; Moya-Laraño et al. 2002a; Moya-Laraño et al. 2003b; Williams et al. 2006). Also hares often destroyed the nests. Within the core study area, burrows were rebuilt and dead females replaced by new ones with the same maturation status on a weekly basis. Within the edge of the study area, reconstruction of burrows and replacement of females followed a less regular pattern. However, it was carried out at least twice along the period of study. With this procedure we ensured that every day, about 75% of the burrows were occupied by females within the core area.

Starting on June 10<sup>th</sup>, we released in the centre of the study plot eight cohorts of between 38 and 41 adult males of *L. tarantula* that had been captured in the surrounding area –319 males released in total. Male cohorts were released at weekly intervals (on Sundays). Each male was released in the centre of a randomly-allocated grid cell, around the central group of burrows (Fig 1). Except for the first week, we recorded the exact grid where individual males were released. All releases occurred around 10 p.m.

### **Capture, marking and measurement of spiders**

Males were captured a few days before their release in the study area ( $n = 320$ , Mean = 7.18, SD = 2.82 days). They were kept at room temperature in individual cylindrical jars ( $\varnothing 6.5\text{cm} \times 10\text{cm}$ ) until their release within the experimental plot. Males were weighed to the nearest 0.01 g and the following morphological traits measured under a dissection microscope (nearest 0.1 mm): carapace width and length, opisthosoma width and length, first and fourth tibia length, and first and fourth tibia diameter. Measurements were made within a few hours after we captured the individuals. All animals were measured by the same observer (GC) with high intra-observer repeatability: all  $R > 0.94$ ;  $p < 0.001$ ;  $n = 20$ . Each spider was uniquely marked with water paint markings on the legs (Moya-Laraño 1999). Given that leg autotomy occurs very often within wolf spiders (Brueseke et al. 2001; Wrinn & Uetz 2007), we also included in our study males which lacked one or two complete legs or some leg segments, as well as those who had some regenerated legs. For each male, the number and location of missing legs were recorded.

### **Collection of data**

*Location of males.* The position of males was recorded during night censuses. Each census night, between 00:00 a.m. and 5:00 a.m., two observers surveyed all the surface of the study plot by slowly walking through all the horizontal corridors (rows of the square grid), midway between the limiting sticks, looking for males with the help of head lamps (Moya-Laraño 1999). One observer surveyed the “upper” and the other the “lower” half of the study plot (upper and lower according to the orientation of Fig. 1). Each night we randomly chose the row as well as the direction in which each observer started walking, and the survey continued until both observers returned to their starting point. The first sampling of the week was done the same night that males were released (hereafter referred to as “night 1”), leaving at least two hours between the release and the beginning of the survey. The first two weeks of the study, night censuses were further conducted on nights 2-5, but on weeks 3 to 8 of the study night censuses were only conducted four times per week, on nights 1, 2, 4 and 5. Every time we found a male we identified him and

recorded the time of day and its spatial position trying to disturb him as little as possible. The position assigned to a particular male were the coordinates of the centre of the 6 x 6 m square where the male was detected within the grid. Non-experimental males were captured upon encounter and kept for subsequent releases.

*Mating success.* Mating occurs mainly inside the burrow and during the daylight hours (Moya-Laraño et al. 2003a; Moya-Laraño et al. 2003b; Fernandez-Montraveta & Cuadrado 2003b; Moya-Laraño et al. 2004). Thus, to monitor mating events we visited all the burrows once per day between 10:00 a.m and 1:00 p.m, interval of time when most of the copulation events take place (Moya-Laraño et al. 2003b). Visits took place from Monday to Friday during every week of the study. As with the night survey, every day we randomly chose the starting point and the direction to carry out the sampling survey. We recorded all copulation and cohabitation events observed (Fernandez-Montraveta & Cuadrado 2003a; Moya-Laraño et al. 2003b), and the identity of the males and females involved.

## **Data analysis**

*Male morphology:* Because all our morphological measurements were highly correlated (all  $r > 0.58$ ,  $p < 0.001$ ), we ran a principal component analysis with varimax rotation to extract independent measurements of body size and body condition. In the principal component analysis, body mass was included as the cubic root of body mass to bring this variable to the same scale than the other morphological variables. We extracted the three first principal components, which explained 92.15% of the variance. In the PC1, carapace width and length and first and fourth tibia length had significant loads (loadings between 0.74 and 0.86), so PC1 represented fixed body size. In the PC2 only opisthosoma width and length had significant loadings (loadings between 0.86 and 0.90), thus PC2 represented body condition. Finally in PC3 the diameters of first and fourth legs had significant loadings (loadings between 0.77 and 0.81), consequently PC3 grouped the diameters. We used these three principal components instead of the original morphological variables as predictors for hypothesis testing in further analysis.

*Male average speed or cruise speed:* We calculated the average speed at which males moved during the night of their release by calculating the Euclidian distance between the release and recapture points and then dividing this value by the interval of time spent between the release and the recapture of a particular individual. The units of the average speed during the night of release were  $m \cdot h^{-1}$ . In order to qualitatively describe the movement pattern of males of *L. tarantula*, we used the average speed during the night of release to estimate the distance potentially travelled by each male per night. In addition, we used density contour plots to visualize the dynamics of the spatial distribution of males during the time we conducted our study. For simplicity, we combined data from release weeks 1, 2 and 3 in one set of plots, which represent the movement pattern of males at the beginning of the mating season, and then we combined data from release weeks 5, 6 and 7 in a second set of plots, which represent the movement pattern of males at the end of the mating season. Each density contour plot represents the spatial distribution of males a certain number of days after their release. For instance, if a plot represents the distribution of males one or two days after their release, the colour of a position in the study plot indicates the number of males observed on the corresponding cell of the square grid one or two days after their release. Note that the number of males indicated by the density contour plot does not necessarily mean that all those males were at the corresponding cell on the same night. For instance, in the map corresponding to recaptures one or two days after the release for the early part of the experiment (weeks 1-3), if we read that there were six males in a certain cell it is possible that the six males were there on a given night, but it is also possible that two of these males corresponded to the first male cohort (week 1), two other males to the second male cohort (week 2), and the remaining two males to the third cohort (week 3). In this latter scenario, at most two males would have coincided in the grid cell the same night. Furthermore, of the two males recorded at the grid cell during week 1, the two may be have recorded on the same day (one or two days after their release), or one may have been observed one day after their release and the other one two days after their release. The colour of a grid cell in a contour plot (the number it indicates) should therefore be read as an indication of the instantaneous probability that, a certain time after his release, a male is found at that cell. Warmer colours (colours representing higher numbers of males recorded)

correspond to higher probabilities. For each of the two groups of data we made six plots, corresponding to the position where the males were released; where they were recaptured on the night of release, which we called time 0; plot of the recaptures from 1 and 2 days after release; plot of the recaptures from 3 and 4 days after release; plot of the recaptures from days 7 to 10 after release; plot of the recaptures from 11 days or more after release. In order to assess whether search patterns and activity changed through the season, we run two GLM analyses to test whether male residence time in the experimental plot and average speed differed between males released during weeks 1-3 and males released during weeks 5-7. Besides, for those males recaptured on consecutive nights, we tested whether the distance covered between the two consecutive recaptures changed through the mating season. We did this running a GLM with distance (log transformed) as the dependent variable and sampling date as the predictor.

*Predictors of male average speed or cruise speed:* We exclude from this analysis those males that did not move during the night of release (i.e. they were recaptured in the same grid of release), because these were likely males that had not started their mate searching activities yet. We include as predictor variables PC1, PC2, and PC3 extracted from the principal component analysis of male morphology variables as estimators of fixed body size, body condition and leg diameter respectively (see above) and two categorical variables describing whether the male lacked some leg or had some defective leg –i.e. regenerated legs or legs where some segment is lacking. We also included the release date as an independent variable in order to analyze whether there were changes in the observed pattern through the mating season. In order to verify that the number of days that each male had remained captured before its release did not affect male behaviour, we included this variable as potential predictor in the initial model too. For the response variable male cruise speed –i.e. average speed during the release night- we ran a generalized linear model including different combinations of the predictor variables explained above and estimated the most parsimonious model using Akaike's Information Criterion (AIC) corrected for small sample sizes (Akaike 1987; Hurvich & Tsai 1989; Burnham & Anderson 2002). The response variable was log-transformed to meet the assumptions of the model. We tested the significance of the predictor variables

for the two most parsimonious models by running GLM analyses of the two models with the lowest AICc (Hurvich & Tsai 1989).

*Selection on body size, body condition and mobility:* We followed the methodology proposed by Lande & Arnold (Lande & Arnold 1983) to measure multivariate selection on the three male correlated traits: fixed body size (PC1), body condition (PC2) and mobility (averages speed during the night of release). We tested both linear coefficients to estimate directional selection, as well as quadratic coefficients to estimate stabilizing or disruptive selection. We also tested for correlational selection by including interaction terms between all pairs of traits. Our estimator of male fitness was the number of females with which the male was observed to copulate in the study plot. We ran a generalized linear model with a Poisson distribution. However, because the mobility of males was higher than we had anticipated, males spent relatively little time within the experimental plot ( $n = 319$ , Mean = 6.79, SD = 7.93 days), and consequently they probably copulated with more females after leaving the study plot. To partially account for this problem we introduced as an offset in the multivariate Poisson regression the logarithm of the number of days that males remained in the study plot (= date when male was last detected - date of release + 1). Essentially, this corresponds to using as our fitness response variable the average number of females with which the male copulates per day (Dobson & Barnett 2008)

Selection gradients can be readily derived from regression coefficients in standard multiple-regression analyses (Lande & Arnold 1983). When fitness data are not normally distributed, some authors use generalized linear models to test whether their explanatory variables affect fitness, and revert to standard multiple-regression analyses (on the not normally distributed fitness measurement) to estimate selection gradients. Janzen and Stern (Janzen & Stern 1998) explain why this approach is inappropriate and propose how to estimate selection gradients using logistic regression. A straightforward extension of their model to the case of Poisson regression leads to the following algorithm to estimate average selection gradients when fitness measurements follow a Poisson distribution. Let the random variable  $Y_i$  denote the number of copulation events for male  $i$ . The expected value of this variable,  $\mu_i = E(Y_i)$ , is given by the linear part of the GLM,

$$\mu_i = E(Y_i) = t_i \cdot \theta_i \quad (1)$$

where  $\theta_i$ , the average number of copulations per day, is related to the independent variables of the regression model through the exponential link function,

$$\theta_i = \exp(\bar{x}_i \cdot \bar{\beta}), \quad (2)$$

where  $\bar{x}_i \cdot \bar{\beta}$  stands for the dot (scalar) product between the vector of traits corresponding to male  $i$ ,  $\bar{x}_i$ , and the vector of regression coefficients,  $\bar{\beta}$ . Because we cannot distinguish between mortality and emigration, we cannot estimate male survival with our data. Therefore, we take as a measure of fitness,  $W$ , the average number of copulations per day:

$$W = \frac{1}{t} \cdot E(Y) = \exp(\bar{x} \cdot \bar{\beta}) \quad (3)$$

From Equation 3, the selection gradient for trait  $j$  is given by

$$\frac{\partial W}{\partial x_j} = \beta_j \cdot \exp(\bar{x} \cdot \bar{\beta}) \quad (4)$$

Finally, the average selection gradient is estimated averaging over all the  $N$  males in our sample (Janzen & Stern 1998):

$$\left\langle \frac{\partial W}{\partial x_j} \right\rangle = \beta_j \cdot \left[ \frac{1}{N} \cdot \sum_{i=1}^N \exp(\bar{x}_i \cdot \bar{\beta}) \right] \quad (5)$$

Note that the vector  $\bar{x}$  (as in Equation 4) denotes the vector of predictors for an unspecified male, while  $\bar{x}_i$  denotes the same vector for male  $i$  and the scalar  $x_j$  stands for the  $j$ -th component (i.e. the  $j$ -th trait) of the vector  $\bar{x}$  (unspecified male). If we wanted to specify both the vector component (the trait: fixed size, condition...) and the male, a system with two subindexes would be required – but such level of specification is not necessary for our reasoning. Once we have calculated the average value of the selection gradient, all that remains to be done is to divide the value obtained from Equation 5 by the average fitness in the population (Lande & Arnold 1983; Janzen & Stern 1998),  $\langle W \rangle$ :

$$\langle W \rangle = \frac{1}{N} \cdot \sum_{i=1}^N \frac{y_i}{t_i}.$$

The predictor variables included in the model were centred by subtracting their mean. We calculated a variance-standardized selection gradient by multiplying the partial regression coefficient by the standard deviation of the trait.

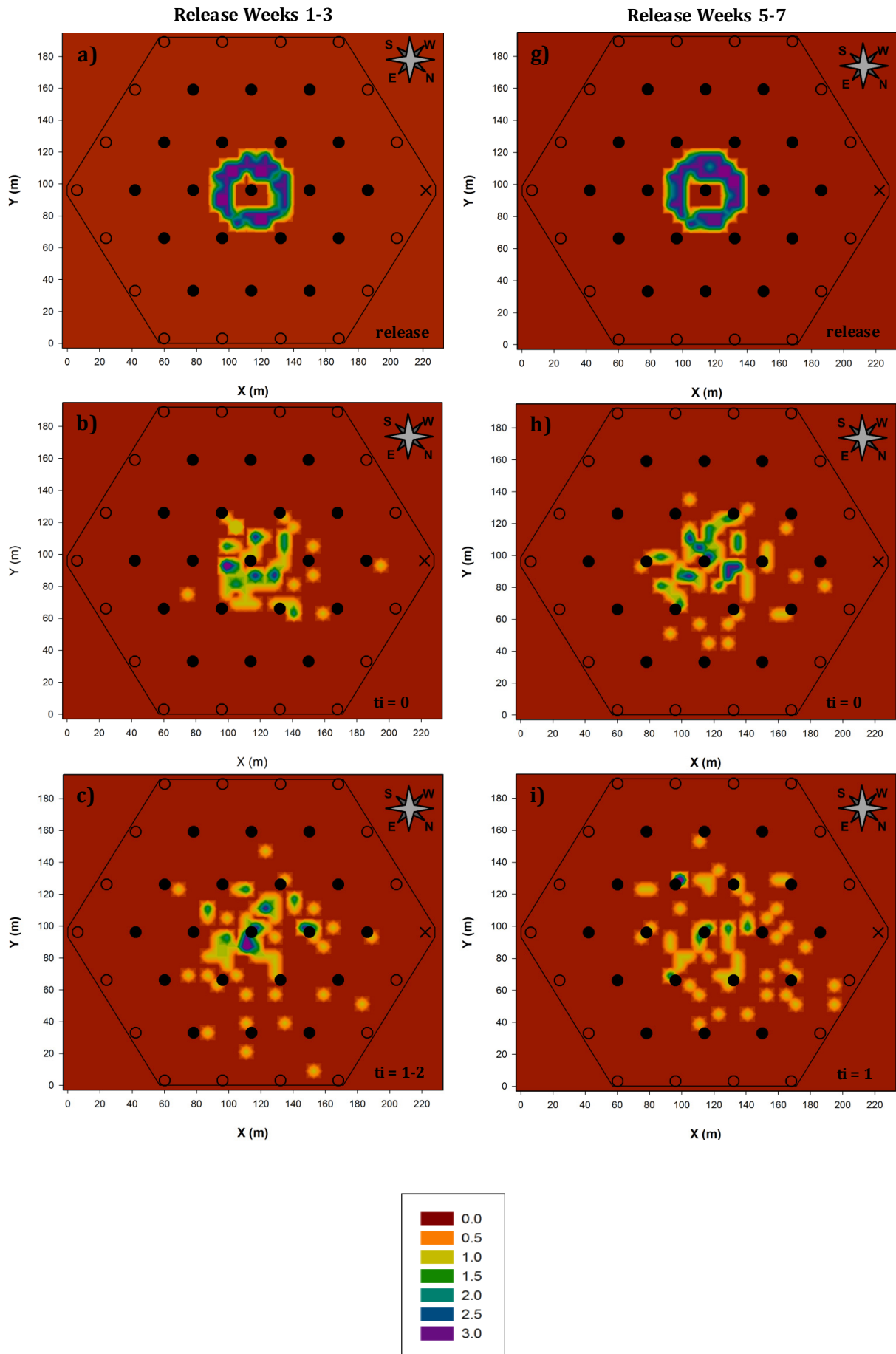
In addition, we assessed whether there was an effect of the advance of the mating season on our response variable (i.e. probability to copulate per day), by running the same model explained above –a generalized linear analysis with a Poisson distribution and the logarithm of the number of days that males remained within the study plot as offset–, but with date of release –linear and quadratic term– as the unique predictor variable. Furthermore, to test whether the number of available females varied through the mating season we run a generalized linear model with a Poisson distribution with the total number of copulations recorded each day as the dependent variable and sampling date –linear and quadratic terms– as independent variables.

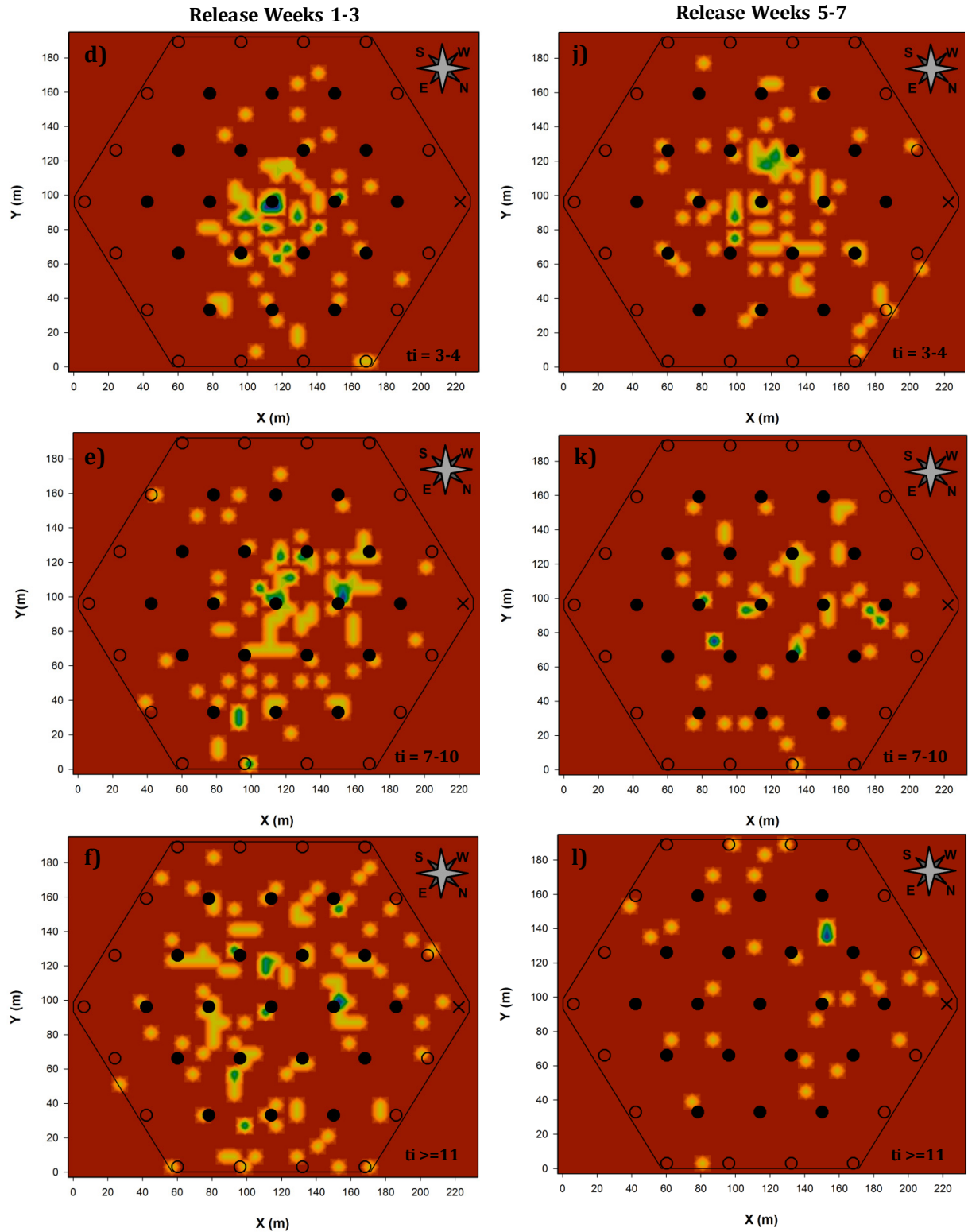
## Results

*General description of the pattern of male mobility:* Out of the 319 males that we released, 197 were recaptured on the night of their release, 93 were recaptured at least once but not seen on the night of their release, and 29 were never observed following their release. Because we did not record the exact release point for the males of the first cohort, we got average speed data on the night of release only for 177 males. Males moved at an average cruise speed of  $4.12 \pm 3.84 \text{ m} \cdot \text{h}^{-1}$ . Considering that there were about 8 hours of darkness at the time we carried out our study – between 10 p.m. and 6:00 a.m. approximately–, this means that males can move an average of 32.96 m per night. This result implies that an average male would need to move in the same direction during three days to cover the distance between the centre and the edge of the experimental field. Looking at the distribution of recapture locations across time after the release, (Fig. 2) we observed that males of *L. tarantula* seemed to move from the centre to the edge of the study area, thereafter



leaving the experimental field. During the first weeks of study (i.e. data from weeks 1-3 combined), one male was recaptured outside the core area on the release night itself, and males were occupying the entire surface of the experimental area after one week (Figs. 2a-2f). Male dispersal from their release sites was even faster during the last weeks of study (i.e. data from weeks 5-7 combined), when there was a roughly even distribution of males across the entire study plot only three or four days after their release, and a big proportion of them had probably left a week to ten days after the release (Figs. 2g-2l). Actually, considering the whole period of study, males released during the first three weeks of study remained in average significantly more time within the experimental area than those released during the weeks four, five and six (Time within the experimental field: weeks 1-3,  $10.82 \pm 9.83$  days; weeks 4-6,  $4.60 \pm 5.18$  days;  $F_{1, 237} = 34.59$ ,  $p < 0.001$ ). However, this last result should be taken with cautious given that we estimated the interval of time that males remained within the experimental plot from the last time that a particular male was detected, while it always possible that a male stayed some more time beyond this point without being detected anymore. Nonetheless, considering those males within these two sets of data for which we could estimate cruise speed during the night of release, we found that the average speed did not differ significantly between these two sets of data representing the beginning and the end of the mating season ( $F_{1, 128} = 2.33$ ,  $p = 0.13$ ), while the distance covered between two consecutive days significantly increased with sampling date (estimate =  $0.014 \pm 0.004$ ,  $F_{1, 303} = 14.929$ ,  $p < 0.001$ ), strongly suggesting that males increase their searching activity as the season progresses.





**Figure 2:** Density contour plots to visualize the movement of males in the real area of the study during the time we conducted our study. Plots *a* to *f* (left column) show data from **release weeks 1, 2 and 3** combined and plots *g* to *l* (right column) show data from **release weeks 5, 6 and 7** combined. The colour of a grid cell in a contour plot (the number it indicates) should therefore be read as an indication of the probability that, a certain time after his release, a male is found at that cell. Warmer colours correspond to higher probabilities. Plots *a*, *g*) corresponds to the position of male **release** (plots *a*, *g*) and position of recaptures at different time intervals after it: plots *b*, *h*, **ti = 0** recaptures from the same night of release; plot *c*, **ti=1-2** recaptures from 1 and 2 days; plot *i*, **ti=1** recaptures from 1 day after release; plots *d*, *j*, **ti=3-4** recaptures from 3 and 4 days after release; plots *e*, *k*, **ti=7-10** recaptures from days 7 to 10 after release; plots *f*, *l*, **ti >= 11** recaptures from 11 days or more after release. See text for more details.

*Predictors of male average speed or cruise speed:* Only the variables PC2 representing body condition, PC1 representing fixed body size and the number of missing legs were included in the two models with the lowest AICc value. Notice that, even though we cannot select a unique preferred model strictly adhering to AIC, because there were nine models with a  $\Delta\text{AICc} < 2$ , the three variables included in our selected models were those which had far more weight on the response variables across the 9 models with a  $\Delta\text{AICc} < 2$  (Supporting Information 1). There was a non significant trend for smaller males to move faster. Body condition was positively related to average speed in both models even though this result was only marginally significant. Surprisingly we found a positive significant effect of missing legs on speed according to the two models with the lowest AICc. Thus, males who lacked one or two legs before their release in the experimental plot had significantly higher average speeds (Table 1).

**Table 1: The two selected models according to AICc to explain male mobility.** The dependent variable was mean speed during the night of release (log-transformed). “**PC1\_fixed size**”, PC1 groups variables related to fixed body size; “**PC2\_condition**”, PC2 groups variables related to body condition; “**missingl**” missing legs: 1 = males lacked one or 2 legs, 0 = male did not lack any leg. Bold letters show significant results.

GLM: Dependent variable log_mean speed							
Model	Independent Variables	Level of effect	Estimate	SE	t-value	d.f.	p
1	PC2_condition		0.074	0.042	1.785	149	0.077
	<b>Missing</b>	<b>1</b>	<b>0.029</b>	<b>0</b>	<b>2.465</b>	<b>149</b>	<b>0.015</b>
2	PC1_fixed size		-0.058	0.042	-1.392	148	0.166
	PC2_condition		0.078	0.042	1.876	148	0.062
	<b>Missing</b>	<b>1</b>	<b>0.194</b>	<b>0.070</b>	<b>2.779</b>	<b>148</b>	<b>0.006</b>

*Selection on body size, body condition and mobility:* The linear selection analysis revealed substantial directional selection on body condition and mobility, being selection on mobility highly significant. Sexual selection strongly favoured males with higher average speed and males in better condition, although this last result was only marginally significant. Conversely, we did not observe directional selection on fixed body size (Table 2). We found no evidence of stabilizing or disruptive selection (all the partial regression coefficients of the quadratic terms had  $p > 0.16$ ) on the three variables that we examined, nor correlational selection among them (all the partial regression coefficients of crossed terms had  $p > 0.53$ ) (Supporting Information 2). Finally, release date had a slight but significantly

positive effect on our fitness variable, there being a curvilinear relationship between release date and the average number of copulations per day ( $n=177$ ; linear term: estimate =  $0.103 \pm 0.038$ ,  $\chi^2 = 8.308$ ,  $p = 0.004$ ; quadratic term: estimate =  $-0.002 \pm 0.001$ ,  $\chi^2 = 3.973$ ,  $p = 0.046$ ). Thus, the reproductive success of males increased with their release date, until it reached a maximum at approximately day 32. In addition, there was also a significant curvilinear relationship between the number of copulations recorded per day and the sampling date ( $n=177$ ; linear term: estimate =  $0.322 \pm 0.044$ ,  $\chi^2 = 24.085$ ,  $p < 0.001$ ; quadratic term: estimate =  $-0.005 \pm 0.001$ ,  $\chi^2 = 20.584$ ,  $p < 0.001$ ), with a peak of receptive females at approximately day 30 after the beginning of our experiment. These two last results confirm that that our study period covered most of the 2007 mating season for *L. tarantula*, although there were probably some mating events after we finished recording.

**Table 2: Linear selection analysis (directional) using a generalized non-linear model (GLZ) with poisson distribution and a log link function;** the number of days that each male remained in the experimental field plot (log-transformed) was included as offset in the model. The fitness component examined was the probability of copulate each day. The tested traits were: **PC1\_fixed size**", PC1 groups variables related to fixed body size; **PC2\_condition**", PC2 groups variables related to body condition; **Mean speed** of each male during the night of release ( $m \cdot h^{-1}$ ). Non-standardized and variance-standardized coefficient are provided. Bold letters show significant results. ( $n = 177$ )

Directional selection analysis							
Model	Trait	Non-standardized estimates		Variance-standardized selection gradient		$\chi^2$	p
		b	SE	$\beta$	SE		
1	PC1_fixed size	0.162	0.136	0.408	0.435	1.340	0.247
	PC2_condition	0.263	0.137	0.266	0.138	3.674	0.055
	<b>Mean speed</b>	<b>0.406</b>	<b>0.123</b>	<b>0.378</b>	<b>0.114</b>	<b>8.605</b>	<b>0.003</b>

## Discussion

In a field survey involving a regular distribution of female burrows, we found evidence for sexual selection by scramble competition, favouring males of high mobility and in better condition.

***General issues about the pattern of movement during mate searching***

Males of *L. tarantula* were able to cover in average 33 m each night, which is a considerable high value compared to available data for other related species. In *Hygrolycosa rubrofasciata*, another species of wolf spider, about four times smaller than *L. tarantula*, males only cover on average about 2 m each night (Kotiaho et al. 1999), which scaling by the size of the spider, it means that males of *L. tarantula* move at a rate four times higher. The average speed did not change during the mating season, but males remained significantly less time within the experimental area at the end of the study period, which could result from an increase in directionality or a decrease in the proportion of time spent resting as the reproductive period advanced. Towards the end of the mating season females are less receptive and fewer females remain unmated (Rabaneda-Bueno et al. 2008) and consequently, males could intensify their searching activity in order to increase their chance to mate. Alternatively, a higher predation rate at the end of the mating season could be responsible of the same observed pattern, i.e. males being recaptured within the study area during a shorter period of time, given that predation rate has been documented to be high in this population (Williams et al. 2006; Rabaneda-Bueno et al. 2008). Unfortunately, our experimental design did not allow us to distinguish between emigration and mortality, since our study field was open and males could freely move within and outside of the area. However, the spatial distribution of recaptures shows that males reached the edge of the study site sooner towards the end of the season (Fig. 2), at the same time that the distance covered per night increased significantly as the mating season progressed, suggesting that the process responsible for the decrease in residence time was emigration, and not mortality.

The movement pattern of males is consistent with the idea of a non-existence of long-distance olfactory signals produced for receptive females to attract males (Fernandez-Montraveta & Cuadrado 2009). Males dispersed from the centre to the edge of the plot, leaving the study area after relatively few days. Given that most experimental females were captured within the surrounding area before starting this study, the density of females was probably much higher within the experimental field than in the surrounding area at the time that the study was carried out. Thus,

the strategy of *L. tarantula* males during mate searching may consist in a high mobility rate without any particular direction, in order to maximize the explored surface and consequently the probability to detect a receptive female in their trajectory, as it has been found in other arthropods (Hanks et al. 1996a; Hanks et al. 1996b).

Although our experiment was originally devised to uncover at which spatial scale sexual selection by scramble competition could operate (patches at 2, 8.5 and 36 m), the unexpectedly high mobility of this species suggests that sexual selection will occur at, the very least, the highest scales (patches separated by 36 m that are reached on average in one single day). Thus, only the newest technologies –e.g. micro radio transmitters (Kelly et al. 2008; Wikelski et al. 2010) or harmonic radar (Capaldi et al. 2000) – will reveal the spatial scale at which selection occurs.

### ***Morphology vs average or cruise speed***

Body condition was positively related to average speed (Table 1). This result is consistent with a parallel study carried out with males of *L. tarantula* that measured running speed in field enclosures, in which body condition was also positively related to both cruise and escape speed. This pattern is contrary to the theory of pendulum mechanics which predicts that heavier ground-dwelling spiders will run slower because they will need to apply more energy to elevate their body centre of mass at each step (Moya-Laraño et al. 2008 *manuscript I of this thesis*). Alternatively, since in this population females prefer to mate with males in better condition (R. Rabaneda-Bueno, S. Aguado-de-la-Paz, C. Fernández-Montraveta and J. Moya-Laraño, *unpublished data*), it has been proposed that body mass may act as a quality-dependent handicap (G. Corcobado, M.A. Rodríguez-Gironés & J. Moya-Laraño J, *chapter V of this thesis*). Thus, a better body condition will also imply a heavier load to carry while running, and consequently only high quality males might be able to exhibit better body condition at the same time than higher mobility. Consequently, body condition may act as an honest signal of high quality which is actively selected by females. The results of the present study also are consistent with the idea of body condition acting as a quality-dependent handicap. In contrast with the results of running performance measured in field enclosures, however (G.

Corcobado, M.A. Rodríguez-Gironés & J. Moya-Laraño J, *chapter V of this thesis*), we did not find a significant relationship between fixed body size and average speed, even though a non-significant trend is shown in the second selected model, and in the same direction as in previous results, with smaller males showing a higher average speed.

Surprisingly, we found that males that had previously lost one or two legs ran significantly faster (Table 1). In the wolf spider *Pardosa milvina*, another wolf spider, Brueseke et al. (Brueseke et al. 2001) found that there was no negative effect of losing some legs on locomotor behaviour and prey capture, and these authors discussed these results as evidence of support for the previously proposed “spare leg hypothesis” (Guffey 1998; Guffey 1999). According to this hypothesis, some arachnids would have more legs than they would need to carry out their vital functions, and consequently they would afford to lose some legs with minimal or non-existent costs on individual fitness (Guffey 1998; Guffey 1999). However, it is more difficult to imagine an ecological context where losing legs may trigger positive effects on locomotor abilities. We believe that the most likely explanation for the positive relationship found here between losing legs and average speed was due to a correlational effect, in which the more mobile males would be exposed to a higher probability of encountering a predator and as a result of higher predation risk these males would have lost some legs. Thus, the fact of losing some legs might be the consequence, instead of the cause, of being more mobile. However, this idea can only be confirmed experimentally in future research.

### ***Selection on body size, body condition and mobility***

We found evidence of directional selection on body condition and average speed, but not on body size. Sexual selection favoured males in better condition and males moving at higher average speed during mate searching (Table 2). The lack of selection on fixed body size is consistent with the idea that intra-sexual selection by male combat plays a minor role in this population, suggested from the finding that male size did not predict the result of agonistic interactions between males for access to females (Fernandez-Montraveta & Ortega 1993). The significant directional selection on average speed during mate searching highlights the



predicted relevance of sexual selection by scramble competition in *L. tarantula* and suggests that scramble competition may also be an important source of selection in species with moderate female-biased SSD, such as *L. tarantula*, instead of affecting only species with strong SSD. Additionally, the fact that we found directional selection on average speed agrees with the idea that it is worth evaluating selection on behaviour or functional capacities, which may be the result of several underlying physiological processes acting at the same time, despite the fact that most of the previous studies measuring selection in nature have focused on morphological traits (Irschick et al. 2008).

Interestingly, the multiple regression analyses ran to evaluate directional selection revealed that body condition has direct and indirect effects on fitness. First, body condition indirectly affects fitness since there is a positive relationship between this trait and average speed, which in turn is linked to higher mating success. Second, body condition is directly related to fitness given that this character is positively related to our fitness estimator, the average number of copulation events per day. Female choice for males in better condition may be responsible of the direct relationship between body condition and fitness, given that it has been found that females in this population prefer to mate with males in better condition and killed males in worse condition (R. Rabaneda-Bueno, S. Aguado-de-la-Paz, C. Fernández-Montraveta and J. Moya-Laraño, *unpublished data*).

It is interesting to note that there was a curvilinear relationship between release date and number of copulations per day. This pattern probably reflects the temporal dynamics of the proportion of receptive females, as the number of copulation events per day also peaks at approximately day 30. Early in the season, there is a relatively high proportion of subadult females. As the season progresses and females mature, the opportunity to copulate increases. But when the proportion of virgin females decreases, the opportunity to copulate starts decreasing again, as females who have copulated at least once are more likely to kill and consume approaching males than virgin females (Rabaneda-Bueno et al. 2008). Males that were released before the peak of female availability might maximise their expected fitness locating a virgin female and waiting for her to mature, which probably required relatively short displacements. As the proportion of virgin females

decreased, males were forced to increase the amount of time searching for them, and when the proportion of virgin females became sufficiently small, males were probably forced to switch strategy, looking for the few and far apart non-virgin but receptive females. Thus, male mobility is expected to increase through the season, in agreement with our experimental results. Because cruise speed is probably determined by physiological processes, mobility is probably increased by reducing the proportion of time that males spend resting, although the temporal resolution of our data is too low to confirm this point.

In summary, we found evidence of positive directional selection on body condition and mobility in males of *L. tarantula* during the mating season, which evidenced a role for sexual selection by scramble competition and is in agreement with previous data showing that females mate preferably with males in better body condition. Conversely, despite previous studies arguing for its importance in ground spiders (Brandt and Andrade 2007), we found no evidence of selection on fixed body size. Indeed, contrary to what it has been found in other populations (Moya-Laraño et al. 2003a) we rarely found more than one male guarding a female burrow, suggesting that male contest competition is negligible (Fernandez-Montraveta & Ortega 1993). Thus, the results of the present study highlight the importance of evaluating scramble competition in nature, given that it may play a relevant role not only in species exhibiting extreme SSD, as it has been proposed (Moya-Laraño et al. 2002b; Kelly et al. 2008), but also in species with moderate SSD, as the Mediterranean tarantula wolf spider studied here. Because probably different aspects of sexual selection may affect simultaneously a particular organism (Legrand & Morse 2000), future research should also evaluate other mechanisms involved in pre- and post-copulatory sexual selection, such as sperm competition or male choice (Andersson & Simmons 2006), in order to have an accurate view for how sexual selection acts on each sex within this species.

## **Aknowledgments**

We thank E. De Mas and C. Fernández-Montraveta who helped in field work. This ms has been written under a pre-doctoral grant (FPI; ref: BES-2005-9234) from the Spanish Ministry of Science and Education (MEC)/FEDER to GC. This research has been partially funded by two MEC/FEDER grants (CGL2004-03153 and CGL2007-60520) to JM-L.

## References

- Able, D.J. 1999. Scramble competition selects for greater tailfin size in male red-spotted newts (Amphibia : Salamandridae). *Behavioral Ecology and Sociobiology* 46, 423-428.
- Aisenberg, A., Viera, C. & Costa, F.G. 2007. Daring females, devoted males, and reversed sexual size dimorphism in the sand-dwelling spider *Allocosa brasiliensis* (Araneae, Lycosidae). *Behavioral Ecology and Sociobiology* 62, 29-35.
- Akaike, H. 1987. Factor-Analysis and Aic. *Psychometrika* 52, 317-332.
- Andersson, M. 1994. *Sexual Selection*. Princeton, NJ.: Princeton University Press.
- Andersson, M. & Simmons, L.W. 2006. Sexual selection and mate choice. *Trends in Ecology & Evolution* 21, 296-302.
- Brandt, Y. & Andrade, M.C.B. 2007. What is the matter with the gravity hypothesis? *Functional Ecology* 21, 1182-1183.
- Brueseke, M.A., Rypstra, A.L., Walker, S.E. & Persons, M.H. 2001. Leg autotomy in the wolf spider *Pardosa milvina*: a common phenomenon with few apparent costs. *The American Midland Naturalist* 146, 153-160.
- Burnham, K.P. & Anderson, D.R. 2002. *Model Selection and Multimodel Inference: a Practical Information-Theoretic Approach*. New York: Springer.
- Capaldi, E.A., Smith, A.D., Osborne, J.L., Fahrbach, S.E., Farris, S.M., Reynolds, D.R., Edwards, A.S., Martin, A., Robinson, G.E., Poppy, G.M. & Riley, J.R. 2000. Ontogeny of orientation flight in the honeybee revealed by harmonic radar. *Nature* 403, 537-540.
- Corcobado, G., Rodriguez-Girones, M.A., De Mas, E. & Moya-Laraño, J. 2010. Introducing the refined gravity hypothesis of extreme sexual size dimorphism. *Bmc Evolutionary Biology* 10, 236.
- Darwin, C. 1871. *The Descent of Man, and Selection in Relation to Sex*. London: John Murray.
- De Mas, E., Ribera, C. & Moya-Laraño, J. 2009. Resurrecting the differential mortality model of sexual size dimorphism. *Journal of Evolutionary Biology* 22, 1739-1749.
- Dobson, A. & Barnett, S. 2008. *An Introduction to Generalized Linear Models*. 3<sup>rd</sup> edn. Boca Raton, Florida: Chapman and Hall/CRC.

- Fernandez-Montraveta,C., Lahozbeltra,R. & Ortega,J. 1991. Spatial-Distribution of *Lycosa-Tarentula-Fasciiventris* (Araneae, Lycosidae) in A Population from Central Spain. *Journal of Arachnology* 19, 73-79.
- Fernandez-Montraveta,C. & Ortega,J. 1993. Sex differences in the agonistic behaviour of a lycosid spider (Araneae Lycosidae). *Ethology Ecology & Evolution* 5, 293-301.
- Fernandez-Montraveta,C. & Ruano-Bellido,J. 2000. Female silk and mate attraction in a burrowing wolf-spider (Araneae, Lycosidae). *Bulletin of the British Arachnological Society* 11, 361-366.
- Fernandez-Montraveta,C. & Cuadrado,M. 2003a. Cohabitation between an adult male and a subadult female in a burrowing wolf spider (Araneae, Lycosidae). *Journal of Arachnology* 31(1), 135-138.
- Fernandez-Montraveta,C. & Cuadrado,M. 2003b. Timing and patterns of mating in a free-ranging population of *Lycosa tarantula* (Araneae, Lycosidae) from central Spain. *Canadian Journal of Zoology-Revue Canadienne de Zoologie* 81, 552-555.
- Fernandez-Montraveta,C. & Moya-Laraño,J. 2007. Sex-specific plasticity of growth and maturation size in a spider: implications for sexual size dimorphism. *Journal of Evolutionary Biology* 20, 1689-1699.
- Fernandez-Montraveta,C. & Cuadrado,M. 2009. Mate Attraction in a Burrowing Wolf-Spider (Araneae, Lycosidae) is not Olfactory Mediated. *Ethology* 115, 375-383.
- Foelix,R.F. 1996. *Biology of Spiders*. 2<sup>nd</sup> edn. Oxford: Oxford University Press.
- Foellmer,M.W. & Fairbairn,D.J. 2005. Selection on male size, leg length and condition during mate search in a sexually highly dimorphic orb-weaving spider. *Oecologia* 142, 653-662.
- Foellmer,M.W. & Moya-Laraño,J. 2007. Sexual Size Dimorphism in Spiders. In: *Sex, Size & Gender Roles. Evolutionary Studies of Sexual Size Dimorphism* (Ed. by D.J.Fairbairn, W.U.Blanckenhorn & T.Szekely), pp. 71-81. New York, Oxford University Press.
- Guffey,C. 1998. Leg autotomy and its potential fitness costs for two species of harvestmen (Arachnida, Opiliones). *Journal of Arachnology* 26, 296-302.
- Guffey,C. 1999. Costs associated with leg autotomy in the harvestmen *Leiobunum nigripes* and *Leiobunum vittatum* (Arachnida : Opiliones). *Canadian Journal of Zoology-Revue Canadienne de Zoologie* 77, 824-830.
- Hanks,L.M., Millar,J.G. & Paine,T.D. 1996a. Body size influences mating success of the eucalyptus longhorned borer (Coleoptera: Cerambycidae). *Journal of Insect Behavior* 9, 369-382.

- Hanks,L.M., Millar,J.G. & Paine,T.D. 1996b. Mating behavior of the eucalyptus longhorned borer (Coleoptera: Cerambycidae) and the adaptive significance of long "horns". *Journal of Insect Behavior* 9, 383-393.
- Hurvich,C.M. & Tsai,C.L. 1989. Regression and Time-Series Model Selection in Small Samples. *Biometrika* 76, 297-307.
- Irschick,D.J., Meyers,J.J., Husak,J.F. & Le Galliard,J.F. 2008. How does selection operate on whole-organism functional performance capacities? A review and synthesis. *Evolutionary Ecology Research* 10, 177-196.
- Janzen,F.J. & Stern,H.S. 1998. Logistic regression for empirical studies of multivariate selection. *Evolution* 52, 1564-1571.
- Kelly,C.D., Bussiere,L.F. & Gwynne,D.T. 2008. Sexual selection for male mobility in a giant insect with female-biased size dimorphism. *American Naturalist* 172, 417-423.
- Kotiaho,J.S., Alatalo,R.V., Mappes,J. & Parri,S. 1999. Sexual signalling and viability in a wolf spider (*Hygrolycosa rubrofasciata*): measurements under laboratory and field conditions. *Behavioral Ecology and Sociobiology* 46, 123-128.
- Lande,R. & Arnold,S.J. 1983. The Measurement of Selection on Correlated Characters. *Evolution* 37, 1210-1226.
- Legrand,R.S. & Morse,D.H. 2000. Factors driving extreme sexual size dimorphism of a sit-and-wait predator under low density. *Biological Journal of the Linnean Society* 71, 643-664.
- Moya-Laraño,J. 1999. Limitación Por El Alimento, Territorialidad y Canibalismo En La Tarántula Mediterránea, *Lycosa Tarentula* (L.) (Araneae, Lycosidae). Autonomous University of Barcelona.
- Moya-Laraño,J. 2002. Senescence and food limitation in a slowly ageing spider. *Functional Ecology* 16, 734-741.
- Moya-Laraño,J., Orta-Ocana,J.M., Antonio Barrientos,J., Bach,C. & Wise,D.H. 2002a. Territoriality in a cannibalistic burrowing wolf spider. *Ecology (Washington D C)* 83.
- Moya-Laraño,J., Halaj,J. & Wise,D.H. 2002b. Climbing to reach females: Romeo should be small. *Evolution* 56, 420-425.
- Moya-Laraño,J., Orta-Ocana,J.M., Barrientos,J.A., Bach,C. & Wise,D.H. 2003a. Intriguing compensation by adult female spiders for food limitation experienced as juveniles. *Oikos* 101, 539-548.
- Moya-Laraño,J., Pascual,J. & Wise,D.H. 2003b. Mating patterns in late-maturing female Mediterranean tarantulas may reflect the costs and benefits of sexual cannibalism. *Animal Behaviour* 66, 469-476.

- Moya-Laraño, J., Pascual, J. & Wise, D.H. 2004. Approach strategy by which male Mediterranean tarantulas adjust to the cannibalistic behaviour of females. *Ethology* 110, 717-724.
- Moya-Laraño, J., El Sayyid, M.E.T. & Fox, C.W. 2007. Smaller beetles are better scramble competitors at cooler temperatures. *Biology Letters* 3, 475-478.
- Moya-Laraño, J., Vinkovic, D., De Mas, E., Corcobado, G. & Moreno, E. 2008. Morphological Evolution of Spiders Predicted by Pendulum Mechanics. *PLoS ONE* 3.
- Moya-Laraño, J., Vinkovic, D., Allard, C.M. & Foellmer, M.W. 2009. Optimal climbing speed explains the evolution of extreme sexual size dimorphism in spiders. *J. Evol. Biol.* 22, 954-963.
- Prenter, J., Perez-Staples, D. & Taylor, P.W. 2010. The effects of morphology and substrate diameter on climbing and locomotor performance in male spiders. *Functional Ecology* 24, 400-408.
- Rabameda-Bueno, R., Rodriguez-Girones, M.A., Aguado-de-la-Paz, S., Fernández-Montraveta, C., De Mas, E., Wise, D.H. & Moya-Laraño, J. 2008. Sexual cannibalism: high incidence in a natural population with benefits to females. *PLoS ONE* 3, e3484.
- Raihani, G., Szekely, T., Serrano-Meneses, M.A., Pitra, C. & Goriup, P. 2006. The influence of sexual selection and male agility on sexual size dimorphism in bustards (Otididae). *Animal Behaviour* 71, 833-838.
- Schwagmeyer, P.L. 1988. Scramble-Competition Polygyny in An Asocial Mammal - Male Mobility and Mating Success. *American Naturalist* 131, 885-892.
- Shuster, S.M. & Wade, M.J. 2003. *Mating Systems and Strategies*. Princeton, NJ: Princeton University Press.
- Thornhill, R. & Alcock, J. 1983. *The Evolution of Insect Mating Systems*. Harvard, Mass: Harvard University Press.
- Wikelski, M., Moxley, J., Eaton-Mordas, A., Lopez-Urbe, M.M., Holland, R., Moskowicz, D., Roubik, D.W. & Kays, R. 2010. Large-Range Movements of Neotropical Orchid Bees Observed via Radio Telemetry. *PLoS ONE* 5.
- Williams, J.L., Moya-Laraño, J. & Wise, D.H. 2006. Burrow decorations as antipredatory devices. *Behavioral Ecology* 17, 586-590.
- Wrinn, K.M. & Uetz, G.W. 2007. Impacts of leg loss and regeneration on body condition, growth, and development time in the wolf spider *Schizocosa ocreata*. *Canadian Journal of Zoology* 85, 823-831.

## Supporting Information I

**Supporting Information 1: Model selection using corrected version of Akaike's information criterion (AICc) to explain male mobility** (log-transformed cruise speed during release night) (N = 177). k refers to the number of parameters. Candidate models with  $\Delta AICc < 2$  are ranked according to their AICc. Weights of the variables within the 9 models with  $\Delta AICc < 2$  are provided. “**PC1**” PC1 groups variables related to fixed body size; “**PC2**” PC2 groups variables related to body condition; “**PC3**” PC3 groups the leg diameters variables; “**missingl**” missing legs: 1 = males lacked one or 2 legs, 0 = male did not lack any leg; “**date**” date of the release in the experimental field; “**cdays**” number of captures days before being release in the experimental field. Bold letters show the selected models and the variables included in them.

No.	Model	k	AICc	$\Delta AICc$	AICc weight	Variable	Variable weight
1.	<b>PC2, missingl</b>	<b>4</b>	<b>231.12</b>	<b>0</b>	<b>0.18</b>	<b>missingl</b>	<b>1</b>
2.	<b>PC1, PC2, missingl</b>	<b>5</b>	<b>231.26</b>	<b>0.14</b>	<b>0.17</b>	<b>PC2</b>	<b>0.82</b>
3.	PC1, PC2, missing, date	6	232.11	0.99	0.11	<b>PC1</b>	<b>0.46</b>
4.	PC2, PC3, missingl	5	232.21	1.10	0.10	PC3	0.21
5.	PC1, PC2, PC3, missingl	6	232.24	1.12	0.10	date	0.19
6.	missingl	3	232.24	1.12	0.10	cdays	0.07
7.	PC2, missing, date	5	232.63	1.51	0.08		
8.	PC1, missingl	4	232.71	1.60	0.08		
9.	PC2, missingl, cdays	5	233.08	1.97	0.07		
					$\sum = 1$		



## Supporting Information 2

**Supporting Information 2: Analysis of stabilizing or disruptive selection and correlational selection.** Generalized non-linear model (GLZ) with a poisson distribution and a log link function of the dependent variable number of copulates of each male. The number of days that each male remained in the experimental field (log-transformed) was included as offset in the model. The fitness component examined was the probability of copulate by day. The tested traits were: **PC1\_fixed size**” PC1 groups variables related to fixed body size; **PC2\_condition**” PC2 groups variables related to body condition; **Mean speed** of each male during the night of release ( $m \cdot h^{-1}$ ). Quadratic terms are included as well as the double product of the different variables. Bold letters show significant results. (n = 177)

<b>Stabilizing or disruptive selection and correlational selection analysis</b>					
<b>Independent Variables</b>	<b>Estimate</b>	<b>SE</b>	<b><math>\chi^2</math></b>	<b>d.f.</b>	<b>P</b>
PC1_fixed size	0.031	0.327	0.009	1	0.925
<b>PC2_condition</b>	0.530	0.313	3.248	1	0.071
<b>Mean speed</b>	<b>0.218</b>	<b>0.093</b>	<b>5.703</b>	<b>1</b>	<b>0.017</b>
PC1 x PC1	-0.009	0.053	0.032	1	0.857
PC2 x PC2	-0.142	0.140	1.145	1	0.285
Mean speed x Mean speed	-0.007	0.005	1.946	1	0.163
PC1 x PC2	0.050	0.177	0.079	1	0.779
PC1 x Mean speed	0.016	0.051	0.107	1	0.743
PC2 x Mean speed	-0.034	0.051	0.453	1	0.501



**DISCUSIÓN**

**INTEGRADORA**



## Resultados y Discusión

Los resultados obtenidos en esta tesis doctoral ponen de manifiesto que la capacidad de movimiento de los individuos desempeña un papel muy importante desde un punto de vista ecológico y evolutivo a lo hora de mejorar nuestra comprensión sobre el funcionamiento de procesos biológicos de vital importancia como son la evolución adaptativa del tamaño y la forma de los individuos (*manuscritos I-VI*) y, por consiguiente, la evolución del SSD (*manuscritos II & III*), la selección sexual (*manuscritos V & VI*), o la evolución y/o mantenimiento de la sociabilidad (*manuscrito IV*). En este sentido la primera conclusión global de esta tesis es la necesidad de que en el futuro se preste más atención a la capacidad de movimiento como un rasgo en sí, debiendo cuantificarse y evaluarse su influencia en cualquier proceso evolutivo, bien sea mediado por la selección natural o sexual, donde cabría esperarse que los individuos más ágiles o más móviles puedan tener alguna ventaja. Si bien existe una línea en investigación bastante potente que ha venido estudiando el movimiento animal desde un punto de vista mecánico (e.g. Swartz 1989; Baatrup & Bayley 1993; Schmitt & Holmes 2001; McNeill 2003; Autumn et al. 2006 y referencias allí citadas), el estudio de la capacidad de movimiento desde un punto de vista ecológico y evolutivo ha sido mucho más escaso y sólo en los últimos años han empezado a encontrarse trabajos que siguen este enfoque (e.g. Moya-Laraño et al. 2002; Biedermann 2002; Moya-Laraño et al. 2007; Torres-Contreras & Vasquez 2007; Kelly et al. 2008; Pruitt 2010). Cabe destacar que la mayoría de los estudios sobre locomoción se han realizado con lacértidos, taxón se han convertido en un sistema modelo para el estudio de la capacidad de movimiento y sus implicaciones en la selección natural y la selección sexual (e.g. Bauwens et al. 1995; Sinervo et al. 2000; Miles 2004; Husak 2006; Calsbeek & Irschick 2007; Irschick et al. 2008; Husak & Fox 2008; Donovan & Gleeson 2008).

Los resultados de esta tesis (*manuscritos I-IV*) aportan avances significativos en el estudio del **punteo** o *bridging*, un modo de locomoción muy común en arañas pero que sorprendentemente hasta la fecha apenas había sido estudiado (Peters 1990; Linn 2001; Ramos et al. 2004; Bonte et al. 2009). Linn (Linn 2001) encontró que el punteo era el modo de locomoción más común en machos de *Nephila*

*clavipes* (Nephiliidae) durante la época reproductora. Resultados preliminares han mostrado el mismo patrón en la araña subsocial *Anelosimus baeza* (Theridiidae) (Corcobado & Rodríguez-Gironés comunicación personal). Los resultados obtenidos en el *manuscrito I* de esta tesis, donde se muestra que la forma de las arañas que habitualmente viven colgadas de sus telas podría haber evolucionado para moverse de forma óptima mediante puenteo, junto con los resultados encontrados en el *manuscrito III* de esta tesis donde se refleja cómo las diferencias en la tendencia a puentear explican patrones de SSD en un estudio comparativo entre distintas especies, apoyan fuertemente la idea de que el puenteo es un medio de locomoción muy importante para arañas que viven en la vegetación, a cierta altura sobre el suelo, y cuyo modo de vida les hace pasar la mayor parte del tiempo colgadas por sus patas. No obstante, sería muy interesante que en el futuro se realizaran trabajos de investigación para evaluar de forma cuantitativa cuánto tiempo dedican los individuos de distintas especies a moverse puenteando en relación a otros modos de locomoción tales como andar sobre superficies horizontales con el peso del cuerpo sostenido sobre sus patas o escalar verticalmente. De hecho sería interesante hacer una reconstrucción filogenética fina de la evolución del puenteo como un rasgo en sí, puesto que los escasos datos disponibles hasta la fecha sugieren la existencia de varios orígenes independientes dado que se conoce la locomoción mediante puenteo en grupos taxonómicos muy distintos.

Los resultados del *manuscrito I* aportan varias líneas de evidencias a favor de la hipótesis de que **la forma de las arañas habría evolucionado de acuerdo a las predicciones de la mecánica pendular**. Puesto que el movimiento de un individuo durante el puenteo se puede asemejar al de un péndulo (Swartz 1989; Hallgrímsson & Swartz 1995; Bertram et al. 1999; Gomes & Ruina 2005), una de las predicciones de esta hipótesis es que en los individuos que viven colgados por sus patas y se desplazan habitualmente mediante puenteo, habrían evolucionado patas desproporcionadamente largas para puentear de forma más eficiente. Por el contrario, en los desplazamientos sobre superficies horizontales, el movimiento de los individuos se relaciona con la dinámica del péndulo invertido (Dickinson et al. 2000; Alexander 2003; Srinivasan & Ruina 2006) y, por tanto, tener patas muy largas en relación al tamaño corporal es desventajoso porque supone mayores

desplazamientos verticales del centro de masas y, por tanto, se necesita más energía para elevar el peso en cada paso. La primera evidencia a favor de la evolución de la forma de las arañas en base a la mecánica pendular (*manuscrito I*) es que las arañas que viven colgadas tienen patas desproporcionadamente más largas que aquellas que viven sobre el suelo. Además, en una especie de araña que vive normalmente colgada de sus patas se encontró que la velocidad de puenteo era mayor que la velocidad andando sobre el suelo. Por último, para arañas relativamente pequeñas existe una relación positiva y lineal entre tamaño y velocidad de carrera sobre el suelo, tanto para arañas de suelo, como para arañas que viven colgadas de sus telas, probablemente porque un mayor tamaño significa una mayor longitud del paso (Bauwens et al. 1995; Framenau 2005). Sin embargo, a partir de un determinado tamaño, mientras que para arañas de suelo esta relación sigue siendo creciente, las que viven colgadas se vuelven más ineficientes corriendo sobre el suelo a medida que aumentan en tamaño, un patrón de acuerdo con las predicciones de la mecánica pendular, puesto que sus patas desproporcionadamente largas les conferirían relativamente poca fuerza en las articulaciones.

También son consistentes con la mecánica pendular los resultados del *manuscrito IV*, puesto que en un estudio comparativo utilizando siete especies del género *Anelosimus* (Theridiidae), todas ellas arañas que viven habitualmente colgadas de sus telas, se encontró que los machos que tenían patas más largas puenteaban a mayor velocidad. En el caso de las hembras, sin embargo, la longitud de la pata no explicó de forma significativa la velocidad de puenteo. Sin embargo, puesto que en las arañas los machos son generalmente el sexo encargado de buscar pareja (Foelix 1996), sería esperable que la presión de selección que llevaría a la evolución de una morfología adaptada al movimiento fuera más fuerte en el caso de los machos.

Los resultados del *manuscrito V* son también consistentes con la mecánica pendular, puesto que muestran que en machos de *Lycosa tarantula* (Lycosidae), una araña de gran tamaño típicamente de suelo, los machos de menor longitud de patas mostraban una menor velocidad de escape. En las arañas de suelo, sin embargo, la relación entre longitud de la pata y velocidad varía entre especies. Esto no es sorprendente, puesto que una mayor longitud de la pata tiene efectos positivos y

negativos sobre la velocidad: aumenta la longitud del paso, pero dificulta el desplazamiento al exigir una mayor energía para elevar el cuerpo en cada paso, como pone de manifiesto la mecánica del péndulo invertido. Así, la velocidad de desplazamiento puede aumentar o disminuir con la longitud de la pata, según sea la importancia relativa de los efectos positivos y negativos. Esto dependerá de la masa del individuo y del rango de longitudes de pata existentes en cada especie. Así, por ejemplo, en machos de *Latrodectus hesperus* (Theridiidae), una araña relativamente pequeña que vive colgada de su tela y en *Jacksonoides queenslandica* (Salticidae), una araña típicamente de suelo de un tamaño parecido, se encontró que los individuos más grandes y, por tanto, con patas más largas corrieron más rápido sobre el suelo (Brandt & Andrade 2007; Prenter et al. 2010). Sin embargo, ninguna de las variables morfológicas analizadas explicó significativamente la velocidad de carrera sobre superficie horizontal en machos de *Argiope keyserlingi* (Araneidae) y *Nephila plumipes* (Nephiliidae), dos especies de araña que viven colgadas de sus telas de un tamaño parecido a las anteriores (Prenter et al. 2010). Por su parte, Pruitt (Pruitt 2010) estudió la velocidad de sprint en *Schizocosa ocreata*, *Hogna helluo* (Lycosidae), *Agelenopsis emertoni* y *Barronopsis texana* (Agelenidae) y no encontró ninguna relación entre tamaño y velocidad en ninguna de las cuatro especies, aunque consistentemente con las predicciones de la mecánica pendular, encontró un efecto negativo de la longitud de la pata en la velocidad de *sprint* después de que los individuos fueran alimentados *ad-libitum* en las dos especies de Agelenidae.

Además de condicionar la forma de los organismos (*manuscrito I* de esta tesis), la dependencia del puenteo para los desplazamientos también impone restricciones sobre el tamaño máximo que los individuos pueden alcanzar, tal como revelan los resultados del *manuscrito II* de esta tesis. Otra de las aportaciones significativas que hace esta tesis en relación a la dispersión mediante puenteo es la demostración, a través de un modelo basado en las propiedades biomecánicas de la seda, de que existe una **restricción física para que las arañas muy grandes puedan utilizar el puenteo como un modo de dispersión eficiente** (*manuscrito II* de esta tesis), **debido a la elasticidad de la seda**. Esta idea había sido sugerida con anterioridad por (Morse & Fritz 1982) al observar que las hembras más pesadas de



*Mysumena vatia* (Thomisidae) no podían dispersarse mediante puenteo dado que su gran peso hacía que el hilo se curvara hasta llegar al suelo, impidiendo por tanto que estos individuos alcanzaran su destino en la rama donde el hilo se había enganchado. Sin embargo, hasta la fecha ningún estudio había profundizado en las propiedades mecánicas de la seda utilizada para puentear y sus implicaciones para la capacidad de dispersión. En este manuscrito se encontró que, a partir de un determinado umbral, el diámetro mínimo requerido para puentear de forma eficiente es menor que el diámetro de las hebras de seda procedente de glándulas del tipo “minor ampullate” –glándulas que producen la seda utilizada para puentear (Peters 1983)– que estos individuos de gran tamaño son capaces de producir, impidiendo por tanto que estas arañas de gran tamaño puedan utilizar el puenteo como un modo de dispersión habitual. Aunque sea difícil establecer un umbral de peso máximo absoluto para el puenteo, debido a la escasez de datos disponibles en relación al diámetro y las propiedades biomecánicas de la seda procedentes de glándulas del tipo “minor ampullate” (Peters 1990; Osaki 1996; Osaki 2003; Hayashi et al. 2004; Blackledge & Hayashi 2006), siguiendo una aproximación conservadora en la elección de los parámetros, el modelo predice que las arañas de más de 200 mg no podrían utilizar el puenteo como un modo de dispersión eficiente. Este umbral es consistente con los datos empíricos mostrados en el *manuscrito III* de esta tesis, donde a partir de experimentos con individuos adultos de ambos sexos pertenecientes a 13 especies de arañas, se encontró que tanto la masa corporal como el tamaño explicaron significativamente la tendencia a puentear, de forma que la probabilidad de puenteo era menor del 5% para aquellos individuos con una masa superior a 118.32 mg (95% CI: 76.30 – 259.41) o un tamaño corporal (ancho de prosoma) superior a 4.17 mm (95% CI: 2.97 – 6.42).

La restricción que el tamaño ejerce sobre la capacidad para puentear eficientemente podría tener algunas implicaciones ecológicas importantes como sería el condicionar la estrategia mediante la que los individuos seleccionan parches o territorios. Así, debido a que las arañas con morfología adaptadas a la dispersión mediante puenteo son torpes moviéndose sobre superficies horizontales (*manuscrito I* de esta tesis), sería esperable que las arañas cuyo peso les impida puentear eficientemente se vean obligadas a quedarse en los territorios que ocupan al alcanzar el umbral de puenteo, incluso si los recursos disminuyen

considerablemente. De hecho, este patrón se ha descrito para las arañas cangrejo, donde se ha encontrado que individuos con más de 200 mg, por ejemplo, no pudieron trasladarse a otros parches situados a unos 10 m de distancia una vez que las flores de los parches que ocupaban se habían marchitado (Morse 2007). En el futuro sería interesante investigar si las estrategias de selección y defensa de territorios en especies que se mueven habitualmente mediante puenteo dependen de que el tamaño corporal que alcancen como adultos les permita o no seguir utilizando el puenteo como un medio de locomoción eficiente. Así por ejemplo, sería esperable que aquellas especies que alcanzan de adultos un tamaño corporal por encima del umbral de puenteo eficiente fueran especialmente selectivas a la hora de establecer sus territorios en estadíos subadultos, mientras aún pueden rastrear el hábitat moviéndose mediante puenteo, y quizás una vez establecido su territorio sería esperable que lo defendieran activamente. Mientras que aquellas especies cuyo tamaño en el estadio adulto no supera el umbral de puenteo eficiente no necesitarían defender tan activamente su territorio, dado que siempre podrían desplazarse a otros parches vacíos cuando los recursos escaseasen.

En el *manuscrito III* de esta tesis se pone de manifiesto otra de las implicaciones del hecho de que las arañas de gran tamaño no puedan usar el puenteo como un mecanismo de dispersión eficiente: la evolución del SSD. Un patrón de SSD es el resultado de distintas presiones de selección actuando sobre machos y hembras (Blanckenhorn 2000; Roff 2002), y puesto que en la mayoría de las arañas los machos son el sexo encargado de buscar pareja (Foelix 1996), se esperaría que, en aquellas especies que utilizan principalmente este mecanismo de locomoción, la presión de selección que favorece un tamaño adecuado para dispersarse de forma eficiente mediante puenteo fuera mayor en machos que en hembras. Si bien está ampliamente aceptado que en arañas el patrón más generalizado de SSD con hembras más grandes que los machos se ha originado por una selección dirigida a aumentar la fecundidad de las hembras por medio de incrementar su tamaño (Head 1995; Coddington et al. 1997; Prenter et al. 1999; Hormiga et al. 2000), en el *manuscrito III* de esta tesis se propone una nueva hipótesis, “**la hipótesis del puenteo-gravedad del SSD extremo**” (en inglés “**Bridging-gravity hypothesis**”), aplicación y mejora de una hipótesis previa

(Moya-Laraño et al. 2002) pero con un mayor poder para explicar tanto la controvertida cuestión de cuál es la presión de selección que hace mantener un tamaño pequeño en los machos (Blanckenhorn 2000; Blanckenhorn 2005), como el amplio rango de variación en los patrones de SSD encontrado en arañas –grupo en el cual en algunas especies las hembras tienen un tamaño ligeramente mayor al de los machos, mientras que en otras el tamaño de las hembras es varios órdenes de magnitud superior al de sus parejas. Aplicando el método comparativo en una muestra de 13 especies que incluía representantes de la familia Thomisidae y el clado Orbiculariae –los dos clados donde se localizan la mayoría de los casos de SSD extremo en arañas y cuyas especies dependen mayoritariamente del puenteo para su dispersión a cortas distancias–, se encontró que el patrón de SSD explicaba las diferencias en tendencia a puentear entre machos y hembras. Así en arañas con escaso SSD, en donde tanto machos como hembras eran pequeños, ambos sexos presentaban una alta tendencia a puentear, sin embargo a medida que el patrón de SSD se acentuaba –es decir, las hembras se hacían gigantes– éstas dejaban de puentear, mientras que los machos siguieron haciéndolo. Estos resultados, junto con las restricciones que las propiedades mecánicas de la seda ejercen sobre las arañas muy grandes, impidiendo que estas puedan utilizar el puenteo como un mecanismo de dispersión eficiente (*manuscrito II* de esta tesis), sugieren que el SSD sería esperable en especies cuyas hembras alcanzan un tamaño corporal de adultas por encima del umbral establecido para el puenteo, y que utilizan este modo de locomoción habitualmente para desplazarse. Lejos de ser excluyentes, la recién propuesta “*bridging-gravity hypothesis*” podría ser complementaria a otras hipótesis propuestas anteriormente para explicar la selección para mantener un tamaño pequeño en machos tales como el Modelo de Mortalidad Diferencial, que predice que la selección favorecería una maduración temprana y una consiguiente disminución del tamaño de los machos debido a una relajación de la competencia intra-sexual por enfrentamientos directos entre machos (Vollrath & Parker 1992; De Mas et al. 2009), o la Hipótesis de la Gravedad, la cual predice que la selección favorecería machos pequeños porque se mueven mejor escalando verticalmente (Moya-Laraño et al. 2002; Moya-Laraño et al. 2009). Sin embargo, la hipótesis del bridging-puenteo ofrece una explicación más global que las hipótesis anteriores incluso para los casos excepcionales de especies dentro de las familias Theraphosidae, Ctenidae,

Oxyopidae and Sparassidae, con hembras gigantes y que viven en la vegetación pero donde no existe SSD, puesto que en estas especies la locomoción mediante puenteo no habría evolucionado como un mecanismo de dispersión (*manuscrito I* de esta tesis).

Si bien en el manuscrito III de esta tesis se pone de manifiesto la existencia de una estrecha relación entre los patrones de SSD y la tendencia a puenteo en hábitats elevados, se necesitaría un estudio más amplio donde se reconstruya filogenéticamente la evolución del puenteo en comparación a la evolución del SSD para confirmar si la evolución del SSD en arañas es una causa o una consecuencia de la dispersión mediante puenteo. Sin embargo, los datos existentes en relación a las bases filogenéticas de la evolución del SSD en el clado Orbiculariae (Hormiga et al. 2000) –uno de los dos grupos taxonómicos independientes donde se encuentran la mayoría de casos de SSD extremo–, así como las evidencias encontradas en esta tesis –*manuscritos II y III*– sugieren que el puenteo habría siempre precedido la evolución del SSD, dado que éste sería el escenario más plausible en el cual presiones de selección opuestas que incrementan el tamaño corporal en las hembras y disminuyen el tamaño en los machos, originarían un patrón de SSD extremo.

En el *manuscrito V* de esta tesis se pone de manifiesto un interesante resultado, que de confirmarse en otras especies condicionaría la forma de enfocar los estudios que investigan las implicaciones de la capacidad locomotora de los organismos en el desarrollo de sus funciones vitales, y en último caso en su eficacia biológica. Así, cuando se monitorizó la velocidad de crucero y la velocidad de escape en cercados de campo bajo condiciones ambientales naturales en machos de *L. tarantula*, se encontró que **no existía ninguna correlación entre la velocidad de crucero y la velocidad de escape, lo cual indica que no pueden extrapolarse los resultados obtenidos mediante análisis de la velocidad de escape a otros contextos, tales como la búsqueda de pareja**, donde la velocidad promedio o velocidad de crucero se espera que tenga mayor relevancia (Husak & Fox 2008). Así mismo, deberían tratarse con precaución los estudios que han intentado explicar la evolución del SSD en arañas en base a la selección por orden de llegada actuando sobre los machos y que han utilizado principalmente la velocidad de escape como variable representativa de la movilidad de los machos (Brandt & Andrade 2007;

Moya-Laraño et al. 2009; Prenter et al. 2010), puesto que los resultados tendrían que interpretarse únicamente en el contexto de la velocidad de escape y, por tanto, selección natural, pero no podrían interpretarse en el contexto de la búsqueda de pareja, y, consecuentemente la selección sexual. Por otro lado, también resultaría apropiado que en aquellos estudios dedicados a evaluar el efecto de la movilidad de los organismos sobre su éxito reproductivo, se analizara no sólo la velocidad a la que los individuos se mueven sino también otras variables relacionadas con la capacidad locomotora como pueden ser la resistencia o las tasas de actividad –es decir, la proporción de tiempo que pasa un individuo moviéndose en relación al tiempo que pasa en reposo–. Hasta la fecha, existen algunos estudios que han medido la resistencia máxima de los individuos en el contexto de la selección sexual, en relación a su habilidad para defender territorios, competir en los combates macho-macho o su capacidad para llevar a cabo exhibiciones de cortejo (Sinervo et al. 2000; Perry et al. 2004; Lailvaux & Irschick 2006; Miles et al. 2007), pero hasta donde nosotros sabemos no existen estudios que hayan evaluado la resistencia de los individuos en relación con la búsqueda de pareja. Aunque no se midieron directamente las tasas de actividad, los resultados encontrados en el *manuscrito VI* de esta tesis sugieren que los individuos podrían modular la tasa a la que buscan hembras a lo largo de la estación reproductora, respondiendo a cambios en el número de hembras receptivas disponibles, resaltando por tanto la importancia de la tasa de actividad de estos individuos –presumiblemente muy relacionada con su resistencia locomotora– en su éxito encontrado pareja.

En contra de lo esperado según la mecánica de los péndulos invertidos, según la cual cuando un individuo se mueve sobre una superficie horizontal la velocidad debería ser inversamente proporcional a la masa, dado que a medida que aumenta la masa corporal se necesita más energía para elevar el cuerpo en cada paso (*manuscrito I* de esta tesis y referencias allí citadas), en esta tesis se encontró que la condición corporal –masa corporal controlada por el tamaño– de machos de *L. tarantula*, se relacionó positivamente con la velocidad de escape y la velocidad de crucero medidas en cercados bajo condiciones ambientales naturales (*manuscrito V* de esta tesis), así como con la velocidad promedio en condiciones naturales y dentro de la estación de apareamiento (*manuscrito VI* de esta tesis). En base a estos resultados y teniendo en cuenta que en esta población las hembras parecen estar

ejerciendo una selección sobre la condición corporal de los machos, dado que por un lado prefieren aparearse con machos en mejor condición y canibalizar machos en peor condición (Rabaneda-Bueno R, Aguado-de-la-Paz S, Fernández-Montraveta C and Moya-Laraño J, *datos no publicados*), y por otro lado, existe una selección direccional positiva sobre la condición de los machos durante la búsqueda de pareja (*manuscrito VI* de esta tesis), proponemos que la **condición corporal podría actuar como un hándicap dependiente de la calidad genética (en inglés *condition as a quality-dependent handicap*)**. Así, la condición corporal se comportaría como una señal honesta (Zahavi 1975; Grafen 1990), puesto que sólo los machos de mejor calidad genética podrían moverse a una elevada velocidad a pesar de tener una masa corporal muy elevada –es decir, tener que transportar una elevada carga al desplazarse–, y las hembras estarían seleccionando estos machos para aparearse (*manuscritos V y VI* de esta tesis). Existen dos evidencias más en favor de que la condición corporal estaría relacionada con la calidad genética de los machos. Por un lado, existe una relación positiva entre la cantidad de comida ingerida en los estadíos juveniles y la condición corporal alcanzada en el estadío adulto, con lo cual la condición corporal del adulto estaría reflejando la habilidad genética para capturar presas. Por otro lado, la condición corporal se mantiene significativamente constante a lo largo de la estación de apareamiento, sugiriendo que los machos pueden regular su condición corporal, por ejemplo alimentándose a una mayor tasa a pesar de su mayor esfuerzo de movilidad. Por su parte, las hembras podrían evaluar fácilmente la condición de los machos a través de las marcas ventrales de color negro de sus opistosomas (Moya-Laraño et al. 2003), aunque esta última idea necesitaría ser verificada experimentalmente.

En el *manuscrito VI* se puso de manifiesto la existencia de una **selección direccional positiva sobre la velocidad de cruce en machos de *L. tarantula*** durante la estación reproductora, lo que sugiere que la **selección sexual por competencia por orden de llegada desempeñaría un papel importante** en esta especie. Si bien se había propuesto que la selección por orden de llegada podría desempeñar un papel importante en arañas caracterizadas por un patrón de SSD extremo con hembras mucho más grande que los machos (Legrand & Morse 2000; Moya-Laraño et al. 2002; Moya-Laraño et al. 2009), y de hecho se evidenció en una

especie de araña de tela orbicular (Foellmer & Fairbairn 2005), hasta la fecha no se había evaluado el papel de la competencia por orden de llegada en una especie de araña con SSD moderado. De hecho, en la literatura encontramos muy pocos trabajos donde se haya evaluado la selección sexual por competencia por orden de llegada bajo condiciones naturales en el campo (Schwagmeyer 1988; Hanks et al. 1996; Able 1999; Foellmer & Fairbairn 2005; Kelly et al. 2008) tal como se ha hecho en esta tesis. Si bien la existencia de una selección positiva sobre la movilidad en los machos durante la búsqueda de pareja (*manuscrito VI* de esta tesis), junto con la estrecha relación encontrada entre morfología y velocidad, tanto de cruceo como de escape de los machos de *L. tarantula* (*manuscritos V y VI* de esta tesis), sugieren un papel relevante de la competencia por orden de llegada en esta especie, en el futuro sería necesario manipular experimentalmente las densidades de machos y hembras a mayores escalas de lo que se ha hecho en otros trabajos (Rabaneda-Bueno et al. 2008) para evaluar cuantitativamente el papel de este tipo de selección intra-sexual. Además, dado que se espera que distintas formas de selección sexual actúen simultáneamente sobre un organismo en particular (Legrand & Morse 2000), en el futuro sería también interesante evaluar otros mecanismos implicados en la selección sexual pre- y post-cópula, tales como la competencia espermática, la elección críptica (Eberhard 1996) o la elección convencional de pareja (Andersson & Simmons 2006).

Por último, en el *manuscrito IV* de esta tesis se muestra un estudio comparativo en que se utilizaron 7 especies del género *Anelosimus* (Theridiidae) y siguiendo una aproximación mecanicista y funcional –enfoque que hasta ahora nunca se había seguido en los estudios dedicados a investigar la evolución de la sociabilidad en arañas–, se encontró que **a medida que el nivel de sociabilidad se intensificaba la habilidad para dispersarse mediante puenteo disminuía progresivamente**, al menos en los machos –el sexo encargado de buscar pareja en la mayoría de las especies de arañas (Foelix 1996) y, por tanto, sexo en el cual se esperaría que la selección hacia aumentar la movilidad fuera más fuerte–. Si bien tradicionalmente se han asociado los cambios en el comportamiento dispersivo a la evolución de la sociabilidad, esta idea, hasta el momento, provenía de evidencias indirectas como el estudio de la estructura de clases de edad, la estructura genética de las poblaciones, la evaluación de la proporción de sexos o algunos datos

observacionales de campo (revisado en Aviles 1997; Lubin & Bilde 2007), siendo ésta la primera vez que se pone de manifiesto a lo largo de la evolución de la sociabilidad, una pérdida de funcionalidad en cuanto a la capacidad para dispersarse se refiere. Además, se encontró que un **acortamiento en la longitud relativa de la pata en relación al tamaño corporal podría ser el mecanismo parcialmente responsable de esta pérdida de habilidad** en el puenteo asociada a la intensificación del nivel de sociabilidad. Puesto que de acuerdo con el modo de vida de estas especies de arañas y los datos encontrados para otra especie europea del mismo género (*manuscrito I* de esta tesis), el puenteo es el mecanismo de dispersión principal de este género, y teniendo en cuenta que unas patas desproporcionadamente largas constituyen la morfología óptima para puentear eficientemente (*manuscrito I* de esta tesis), el hecho de que en las especies más sociales se haya perdido esta morfología especializada para dispersarse mediante puenteo podría establecer un *feedback* positivo sobre la evolución de la sociabilidad, dado que incrementaría los costes asociados a la dispersión –es decir, las especies más sociales con patas más cortas en relación al tamaño corporal, al puentear de forma menos eficiente, podrían sufrir un mayor riesgo de depredación mientras se dispersan mediante puenteo– y ello contribuiría al mantenimiento del mayor nivel de sociabilidad una vez alcanzado. A favor de esta idea, se da el hecho de que la sociabilidad parece ser un rasgo derivado que habría evolucionado a partir de antecesores sub-sociales, y éstos a su vez procederían de especies solitarias que presentaban una extensión de la fase de cuidado parental (Aviles 1997; Johannesen et al. 1998; Agnarsson 2006; Agnarsson et al. 2006; Lubin & Bilde 2007). Por otro lado, el hecho de que la habilidad para puentear disminuya de forma continua con el nivel de sociabilidad (*manuscrito IV* de esta tesis) apoya la idea de que la sociabilidad en lugar de ser un carácter discreto –social vs subsocial– es un rasgo continuo que probablemente engloba todo un conjunto de comportamientos asociados a la vida en grupo (Agnarsson 2006; Purcell & Aviles 2007; Riechert & Jones 2008).



## Bibliografía

- Able, D.J. 1999. Scramble competition selects for greater tailfin size in male red-spotted newts (Amphibia: Salamandridae). *Behavioral Ecology and Sociobiology* 46, 423-428.
- Agnarsson, I. 2006. A revision of the New World eximius lineage of *Anelosimus* (Araneae, Theridiidae) and a phylogenetic analysis using worldwide exemplars. *Zoological Journal of the Linnean Society* 146, 453-593.
- Agnarsson, I., Barrantes, G. & May-Collado, L.J. 2006. Notes on the biology of *Anelosimus pacificus* Levi, 1963 (Theridiidae, Araneae) - evidence for an evolutionary reversal to a less social state. *Journal of Natural History* 40, 2681-2687.
- Alexander, R.M. 2003. *Principles of Animal Locomotion*. Princeton: Princeton University Press.
- Andersson, M. & Simmons, L.W. 2006. Sexual selection and mate choice. *Trends in Ecology & Evolution* 21, 296-302.
- Autumn, K., Hsieh, S.T., Dudek, D.M., Chen, J., Chitaphan, C. & Full, R.J. 2006. Dynamics of geckos running vertically. *Journal of Experimental Biology* 209, 260-272.
- Aviles, L. 1997. Causes and consequences of cooperation and premanent-sociality in spiders. In: The evolution of social behaviour in insects and arachnids. J.C. Choe & In: *The Evolution of Social Behaviour in Insects and Arachnids* (Ed. by J.Choe & B.Crespi), pp. 476-498. Cambridge, Cambridge University Press.
- Baatrup, E. & Bayley, M. 1993. Quantitative-Analysis of Spider Locomotion Employing Computer-Automated Video Tracking. *Physiology & Behavior* 54, 83-90.
- Bauwens, D., Garland, T., Castilla, A.M. & Vandamme, R. 1995. Evolution of Sprint Speed in Lacertid Lizards - Morphological, Physiological, and Behavioral Covariation. *Evolution* 49, 848-863.
- Bertram, J.E.A., Ruina, A., Cannon, C.E., Chang, Y.H. & Coleman, M.J. 1999. A point-mass model of gibbon locomotion. *Journal of Experimental Biology* 202, 2609-2617.
- Biedermann, R. 2002. Mating success in the spittlebug *Cercopis sanguinolenta* (Scopoli, 1763) (Homoptera, Cercopidae): the role of body size and mobility. *Journal of Ethology* 20, 13-18.
- Blackledge, T.A. & Hayashi, C.Y. 2006. Silken toolkits: biomechanics of silk fibers spun by the orb web spider *Argiope argentata* (Fabricius 1775). *Journal of Experimental Biology* 209, 2452-2461.

- Blanckenhorn, W.U. 2000. The evolution of body size: What keeps organisms small? *Quarterly Review of Biology* 75, 385-407.
- Blanckenhorn, W.U. 2005. Behavioral causes and consequences of sexual size dimorphism. *Ethology* 111, 977-1016.
- Bonte, D., De Clercq, N., Zwertvaegher, I. & Lens, L. 2009. Repeatability of dispersal behaviour in a common dwarf spider: evidence for different mechanisms behind short- and long-distance dispersal. *Ecological Entomology* 34, 271-276.
- Brandt, Y. & Andrade, M.C.B. 2007. Testing the gravity hypothesis of sexual size dimorphism: are small males faster climbers? *Functional Ecology* 21, 379-385.
- Calsbeek, R. & Irschick, D.J. 2007. The quick and the dead: Correlational selection on morphology, performance, and habitat use in island lizards. *Evolution* 61, 2493-2503.
- Coddington, J.A., Hormiga, G. & Scharff, N. 1997. Giant female or dwarf male spiders? *Nature* 385, 687-688.
- De Mas, E., Ribera, C. & Moya-Laraño, J. 2009. Resurrecting the differential mortality model of sexual size dimorphism. *Journal of Evolutionary Biology* 22, 1739-1749.
- Dickinson, M.H., Farley, C.T., Full, R.J., Koehl, M.A.R., Kram, R. & Lehman, S. 2000. How animals move: An integrative view. *Science* 288, 100-106.
- Donovan, E.R. & Gleeson, T.T. 2008. Scaling the duration of activity relative to body mass results in similar locomotor performance and metabolic costs in lizards. *Journal of Experimental Biology* 211, 3258-3265.
- Eberhard, W.G. 1996. *Female Control: Sexual Selection by Cryptic Female Choice*. Princeton, N.J.: Princeton University Press.
- Foelix, R.F. 1996. *Biology of Spiders*. 2<sup>nd</sup> edn. Oxford: Oxford University Press.
- Foellmer, M.W. & Fairbairn, D.J. 2005. Selection on male size, leg length and condition during mate search in a sexually highly dimorphic orb-weaving spider. *Oecologia* 142, 653-662.
- Framenau, V.W. 2005. Gender specific differences in activity and home range reflect morphological dimorphism in wolf spiders (Araneae, Lycosidae). *Journal of Arachnology* 33, 334-346.
- Gomes, M.W. & Ruina, A.L. 2005. A five-link 2D brachiating ape model with life-like zero-energy-cost motions. *Journal of Theoretical Biology* 237, 265-278.
- Grafen, A. 1990. Biological Signals As Handicaps. *Journal of Theoretical Biology* 144, 517-546.

- Hallgrimsson, B. & Swartz, S. 1995. Biomechanical Adaptation of Ulnar Cross-Sectional Morphology in Brachiating Primates. *Journal of Morphology* 224, 111-123.
- Hanks, L.M., Millar, J.G. & Paine, T.D. 1996. Mating behavior of the eucalyptus longhorned borer (Coleoptera: Cerambycidae) and the adaptive significance of long "horns". *Journal of Insect Behavior* 9, 383-393.
- Hayashi, C.Y., Blackledge, T.A. & Lewis, R.V. 2004. Molecular and mechanical characterization of aciniform silk: Uniformity of iterated sequence modules in a novel member of the spider silk fibroin gene family. *Molecular Biology and Evolution* 21, 1950-1959.
- Head, G. 1995. Selection on Fecundity and Variation in the Degree of Sexual Size Dimorphism Among Spider Species (Class Araneae). *Evolution* 49, 776-781.
- Hormiga, G., Scharff, N. & Coddington, J.A. 2000. The phylogenetic basis of sexual size dimorphism in orb-weaving spiders (Araneae, Orbiculariae). *Systematic Biology* 49, 435-462.
- Husak, J.F. 2006. Does survival depend on how fast you can run or how fast you do run? *Functional Ecology* 20, 1080-1086.
- Husak, J.F. & Fox, S.F. 2008. Sexual selection on locomotor performance. *Evolutionary Ecology Research* 10, 213-228.
- Irschick, D.J., Meyers, J.J., Husak, J.F. & Le Galliard, J.F. 2008. How does selection operate on whole-organism functional performance capacities? A review and synthesis. *Evolutionary Ecology Research* 10, 177-196.
- Johannesen, J., Baumann, T., Seitz, A. & Veith, M. 1998. The significance of relatedness and gene flow on population genetic structure in the subsocial spider *Eresus cinnaberinus* (Araneae : Eresidae). *Biological Journal of the Linnean Society* 63, 81-98.
- Kelly, C.D., Bussiere, L.F. & Gwynne, D.T. 2008. Sexual selection for male mobility in a giant insect with female-biased size dimorphism. *American Naturalist* 172, 417-423.
- Lailvaux, S.P. & Irschick, D.J. 2006. A functional perspective on sexual selection: insights and future prospects. *Animal Behaviour* 72, 263-273.
- Legrand, R.S. & Morse, D.H. 2000. Factors driving extreme sexual size dimorphism of a sit-and-wait predator under low density. *Biological Journal of the Linnean Society* 71, 643-664.
- Linn, C.D. 2001. The Effect of Male Size on Travel Ability in the Colden Orb-Weaving Spider *Nephila clavipes*: Implications for Sexual Size Dimorphism. Department of Psychology. Tulane University.

- Lubin,Y. & Bilde,T. 2007. The evolution of sociality in spiders. *Advances in the Study of Behavior, Vol 37* 37, 83-145.
- McNeill,A.R. 2003. *Principles of Animal Locomotion*. Princeton: Princeton University Press.
- Miles,D.B. 2004. The race goes to the swift: fitness consequences of variation in sprint performance in juvenile lizards. *Evolutionary Ecology Research* 6, 63-75.
- Miles,D.B., Sinervo,B., Hazard,L.C., Svensson,E.I. & Costa,D. 2007. Relating endocrinology, physiology and behaviour using species with alternative mating strategies. *Functional Ecology* 21, 653-665.
- Morse,D.H. 2007. *Predator Upon a Flower. Life History and Fitness in a Crab Spider*. Cambridge, MA: Harvard University Press.
- Morse,D.H. & Fritz,R.S. 1982. Experimental and Observational Studies of Patch Choice at Different Scales by the Crab Spider *Misumena-Vatia*. *Ecology* 63, 172-182.
- Moya-Laraño,J., Halaj,J. & Wise,D.H. 2002. Climbing to reach females: Romeo should be small. *Evolution* 56, 420-425.
- Moya-Laraño,J., Taylor,P.W. & Fernández-Montraveta,C. 2003. Body patterns as potential amplifiers of size and condition in a territorial spider. *Biological Journal of the Linnean Society* 78, 355-364.
- Moya-Laraño,J., El Sayyid,M.E.T. & Fox,C.W. 2007. Smaller beetles are better scramble competitors at cooler temperatures. *Biology Letters* 3, 475-478.
- Moya-Laraño,J., Vinkovic,D., Allard,C.M. & Foellmer,M.W. 2009. Optimal climbing speed explains the evolution of extreme sexual size dimorphism in spiders. *J. Evol. Biol.* 22, 954-963.
- Osaki,S. 1996. Spider silk as mechanical lifeline. *Nature* 384, 419.
- Osaki,S. 2003. Safety coefficient of the mechanical lifeline of spiders. *Polymer Journal* 35, 261-265.
- Perry,G., Levering,K., Girard,I. & Garland,T. 2004. Locomotor performance and social dominance in male *Anolis cristatellus*. *Animal Behaviour* 67, 37-47.
- Peters,H.M. 1990. On the structure and glandular origin of bridging lines used by spiders for moving to distant places. *Acta Zoologica Fennica* 190, 309-314.
- Peters,R.H. 1983. *The Ecological Implications of Body Size*. Cambridge: Cambridge Univ Press.
- Prenter,J., Elwood,R.W. & Montgomery,W.I. 1999. Sexual size dimorphism and reproductive investment by female spiders: A comparative analysis. *Evolution* 53, 1987-1994.

- Prenter,J., Perez-Staples,D. & Taylor,P.W. 2010. The effects of morphology and substrate diameter on climbing and locomotor performance in male spiders. *Functional Ecology* 24, 400-408.
- Pruitt,J.N. 2010. Differential selection on sprint speed and ad libitum feeding behaviour in active vs. sit-and-wait foraging spiders. *Functional Ecology* 24, 392-399.
- Purcell,J. & Aviles,L. 2007. Smaller colonies and more solitary living mark higher elevation populations of a social spider. *Journal of Animal Ecology* 76, 590-597.
- Rabameda-Bueno,R., Rodriguez-Girones,M.A., Aguado-de-la-Paz,S., Fernández-Montraveta,C., De Mas,E., Wise,D.H. & Moya-Laraño,J. 2008. Sexual cannibalism: high incidence in a natural population with benefits to females. *PLoS ONE* 3, e3484.
- Ramos,M.M., Irschick,D. & Christenson,T. 2004. Overcoming an evolutionary conflict: Removal of a reproductive organ greatly increases locomotor performance. *PNAS* 101 , 4883-4887.
- Riechert,S.E. & Jones,T.C. 2008. Phenotypic variation in the social behaviour of the spider *Anelosimus studiosus* along a latitudinal gradient. *Animal Behaviour* 75, 1893-1902.
- Roff,D.A. 2002. *Life History Evolution*. Sunderland, MA: Sinauer Associates.
- Schmitt,J. & Holmes,P. 2001. Mechanical models for insect locomotion: stability and parameter studies. *Physica D-Nonlinear Phenomena* 156, 139-168.
- Schwagmeyer,P.L. 1988. Scramble-Competition Polygyny in An Asocial Mammal - Male Mobility and Mating Success. *American Naturalist* 131, 885-892.
- Sinervo,B., Miles,D.B., Frankino,W.A., Klukowski,M. & DeNardo,D.F. 2000. Testosterone, endurance, and darwinian fitness: Natural and sexual selection on the physiological bases of alternative male behaviors in side-blotched lizards. *Hormones and Behavior* 38, 222-233.
- Srinivasan,M. & Ruina,A. 2006. Computer optimization of a minimal biped model discovers walking and running. *Nature* 439, 72-75.
- Swartz,S.M. 1989. Pendular Mechanics and the Kinematics and Energetics of Brachiating Locomotion. *International Journal of Primatology* 10, 387-418.
- Torres-Contreras,H. & Vasquez,R.A. 2007. Spatial heterogeneity and nestmate encounters affect locomotion and foraging success in the ant *Dorymyrmex goetschi*. *Ethology* 113, 76-86.
- Vollrath,F. & Parker,G.A. 1992. Sexual Dimorphism and Distorted Sex-Ratios in Spiders. *Nature* 360, 156-159.

Zahavi,A. 1975. Mate Selection - Selection for A Handicap. *Journal of Theoretical Biology* 53, 205-214.

# CONCLUSIONES

# CONCLUSIONS





## Conclusiones

1. La mecánica pendular explica por qué las especies de arañas que viven colgadas de sus telas tienen patas relativamente más largas que las arañas que viven sobre el suelo: este rasgo les confiere una ventaja en la locomoción mediante puenteo, aunque en general suponga una desventaja al correr sobre superficies horizontales.
2. Algunas propiedades mecánicas de la seda como son la resistencia a la rotura y la elasticidad restringen la habilidad de las arañas de gran tamaño para usar el puenteo como un modo de dispersión eficiente.
3. La dependencia del puenteo como mecanismo de dispersión favorece la evolución del dimorfismo sexual, al limitar el tamaño máximo que pueden alcanzar los machos sin perder su capacidad de puentear eficientemente.
4. La evolución de la sociabilidad en arañas del género *Anelosimus* está asociada a una disminución gradual en la tendencia y capacidad para puentear de los machos, y a cambios morfológicos que afectan la eficiencia de puenteo.
5. La pérdida de habilidad para dispersarse mediante puenteo que acompaña a la evolución de la sociabilidad contribuye a su mantenimiento, al incrementar los costes asociados a la dispersión.
6. Los estudios que han utilizado la velocidad de escape para investigar cómo la selección por orden de llegada afecta la evolución del dimorfismo sexual en el tamaño deben ser tomados con precaución, ya que la velocidad de crucero es más relevante que la de escape en el contexto de búsqueda de pareja y, al menos en *Lycosa tarantula*, estas dos velocidades no están correlacionadas.
7. En *Lycosa tarantula*, la condición corporal podría actuar como un *hándicap* que permite a las hembras seleccionar los machos de mejor calidad genética para aparearse.

8. La competencia por orden de llegada parece desempeñar un papel relevante en *Lycosa tarantula*, especie caracterizada por un moderado dimorfismo sexual en el tamaño y cuyos machos están sometidos a una selección direccional positiva sobre la condición corporal y la movilidad.
9. La condición corporal tiene un efecto doble sobre la eficacia biológica de los machos de *Lycosa tarantula*: un efecto indirecto causado por su relación con la velocidad media, la cual a su vez está relacionada con un mayor éxito de apareamiento, y además un efecto directo, al existir una selección direccional positiva sobre este rasgo, lo cual probablemente refleje el hecho de que las hembras prefieren aparearse con machos en mejor condición.

## Conclusions

1. Pendular mechanics explains why spiders which live hanging upside-down from their webs have relatively longer legs than spiders that live on the ground: this trait confers them an advantage in bridging locomotion, although it generally implies a handicap when moving on horizontal surfaces.
2. Some silk properties, such as breaking stress and elasticity, restrict the ability of large spiders to use bridging as an efficient means of dispersal.
3. Dependence on bridging as dispersal mechanism favours the evolution of sexual size dimorphism, because it limits the maximum size that males can reach without losing their capacity to bridge efficiently.
4. The evolution of sociality in spiders of the genus *Anelosimus* is associated with a gradual decrease in male bridging tendency and ability, as well as with morphological changes affecting bridging efficiency.
5. The loss of dispersal ability through bridging accompanying the evolution of sociality contributes to its maintenance, as it increases dispersal costs.
6. We must accept with caution those studies that have used escape speed to investigate how scramble competition affects the evolution of sexual size dimorphism. This is because cruising speed is more relevant than escape speed in the context of mate search and, at least in *Lycosa tarantula*, these two speeds are not correlated.
7. In *Lycosa tarantula*, body condition could act as a handicap allowing females to choose as mates those males with the best genetic condition.
8. Scramble competition seems to play an important role in *Lycosa tarantula*, a species characterised by a moderate sexual size dimorphism in which males are subject to a positive directional selection on body condition and mobility.

9. Body condition has a double effect on fitness in *Lycosa tarantula* males: an indirect effect, mediated through its effect on cruising speed, itself positively related with mating success, and a direct effect, as there is positive directional selection on body condition, probably mediated through female mate choice.

# AGRADECIMIENTOS



## Agradecimientos

*Durante estos años a menudo he tenido la sensación de que hacer la tesis doctoral es como un viaje en una montaña rusa. Empinadas subidas hacia lo alto donde saborear la satisfacción del éxito, seguidas de vertiginosas bajadas que te vuelven del revés. Y en medio de todo eso risas, lágrimas, emoción, miedo, excitación, pérdida de control... Gracias a todos los que habéis estado en las cenas para celebrar conmigo los buenos momentos, y sobre todo gracias a todos los que me habéis apoyado y dado fuerzas en las caídas. Unos y otros habéis hecho que hoy, después de algo más de cinco años y medio, pueda decir que ha merecido la pena.*

*En primer lugar, quiero volver la vista atrás y recordar a los que me pusieron en el inicio de este camino. Gracias a Paco y Chema Valenzuela que, sin saberlo, despertaron un montón de inquietudes de una joven adolescente de un pueblito de Badajoz. Gracias por enseñarme a creer en mí misma, a superar los límites y a no tener miedo de tomar caminos alternativos. Gracias también a Antonio Muñoz que ha sido como mi padrino en esto de la ciencia. Gracias por poner a mi disposición lo mejor de ti, tanto en lo personal como en lo profesional y sobre todo por ser un gran amigo. Con Maritoñi, Maribel y Paco Santiago empecé a hacer planes y a soñar con la investigación, qué distinto ha sido todo de cómo lo planeamos! Gracias a los tres por seguir estando muy cerquita de mí.*

*Gracias, a mis directores de tesis Jordi Moya Laraña y Miguel A. Rodríguez-Gironés por darme la oportunidad de hacer esta tesis. Gracias Jordi por saber aplicar tan bien lo del refuerzo positivo que tantas veces hace falta durante una tesis. No siempre fue fácil ponernos de acuerdo, pero sin duda he aprendido muchísimo de todas esas discusiones, al fin y al cabo acaso no forma parte de la ciencia el cuestionárselo todo? Gracias Miguel por estar dispuesto a explicarme en cualquier momento cualquier tipo de duda, desde las más básicas a las más complejas. Gracias, en definitiva por hacerme fácil, lo que parecía difícil.*

*Gracias toda la gente de la EEZA, o mejor dicho del chumbo que es como a los que hemos estado ahí nos gusta llamarlo, pero de una forma especial a Juan Leiva, Olga Delgado, Andrés Castro, Sebas Vidal, Paco Valera, Roberto Lázaro,*

Paquita, Luisa y Marcela por dar lo mejor de vosotros en vuestro trabajo. Gracias por acogerme como invitada en el chumbo que es vuestra casa y por hacerme hecho sentir tan a gusto ahí. Es especial, gracias a Marcela que ha sido como mi mamá adoptiva en Almería. Gracias también a Sara Aguado de la Paz que hizo mucho más de lo que le tocaba en una temporada de campo muy dura, en medio de todo el agobio y el trabajo, compartimos un montón de buenos momentos y anécdotas.

Gracias también, a todos mis amigos chumberos pero de una forma muy especial a mis chicas Lauri, Ana, Bea, Pepa y Eva de Mas. Dicen que los verdaderos amigos son con los que podemos ser realmente nosotros mismos, pues yo he sentido eso con cada una de vosotras todo el tiempo, habéis hecho que durante estos años en Almería haya sido feliz muchas muchas veces. Quiero mencionar en particular a Ana, con la que he compartido todas las fases de esta tesis, desde el comienzo. Gracias Ana porque además de compartir contigo nuestros avances con el inglés, la estadística, la escritura de manuscritos, los conocimientos sobre ecología evolutiva... de ti he aprendido algo mucho más importante, escuchar más y mejor.

Gracias a Gustavo Hormiga, que me acogió en su laboratorio en Washington DC, y hasta en su casa, en mi primera experiencia en el extranjero, que además resultó bastante accidentada. Fue un placer trabajar contigo, a ver si ahora con un poquito más de tiempo, tengo la oportunidad de sacar un poquillo de jugo científico de todas esas medidas de arañas. Gracias también a Leticia Avilés, de la Universidad de British Columbia, que me dio la oportunidad de conocer el apasionante mundo de las arañas sociales y pasar la mejor temporada de campo de mi vida en Ecuador. Gracias a Max y Karen que fueron mis compañeros de equipo en Ecuador, juntos descubrimos por qué lo llaman "cloud forest", semanas trabajando bajo la lluvia, con el poncho y las botas de gomas como uniforme, alejados de todas las comodidades de la civilización, y sin embargo una experiencia increíblemente gratificante. Gracias a toda la gente humilde de los pueblos de Ecuador por los que pasamos, gracias por acogerme tan amablemente, y por mostrarme la verdadera dignidad de las personas.

Gracias también a la gente del departamento de Ecología Vegetal del CIDE-CSIC en Valencia, que me han acompañado en este último año de tesis, que no ha sido muy fácil, especialmente a mis chicos Bruno, Giorgio y Juli, y a Susana.



*Gracias por preguntarme tantas veces por la tesis, por los ánimos y sobre todo por vuestra comprensión.*

*Y como no, gracias a mis padres Genaro y Carmen, que han luchado durante toda su vida para dar sus hijas un futuro mejor, y a mis hermanas Mari, Conchi y Merce. Gracias por vuestro apoyo incondicional, por aceptarme tal como soy, y eso que soy un poquito "rara" y por soportar todos mis agobios. Gracias por venir a verme allá donde voy en la otra punta de España, o en la otra punta del mundo. Estar lejos de vosotros ha sido sin lugar a dudas lo peor de esta tesis. Sin embargo, recordad que a pesar de la distancia siempre podréis encontrarme al otro lado del teléfono dispuesta a escucharos. Sois mi mayor tesoro.*

*Y por último gracias a Miguel por haber puesto tanta energía en esta tesis y por toda su paciencia ante los inesperados e innumerables cambios de ánimo. Gracias por todo lo que me has enseñado, pero sobre todo por tu cariño y por haberme cuidado tanto. Gracias por hacerme feliz.*

