

UNIVERSIDAD DE GRANADA
FACULTAD DE CIENCIAS ECONÓMICAS Y EMPRESARIALES
DEPARTAMENTO DE TEORÍA E HISTORIA ECONÓMICA

ESSAYS ON ECONOMICS OF CULTURAL TRAITS

Antonios Proestakis

Dissertation Thesis of the doctorate program
Empirical Economics (Economía Empírica)

Defense date: 26 of July 2011

Thesis director:

Professor Pablo Brañas Garza

Thesis Committee

Praveen KUJAL, Professor, University Carlos III, Madrid (Spain)

Nikolaos GEORGANTZÍS, Professor, University of Granada (Spain)

Ayca EBRU, Assistant Professor, Bilgi University of Istanbul (Turkey)

Gonzalo OLCINA-VAUTEREN, Professor, University of Valencia (Spain)

Giuseppe ATTANASI, Assistant Professor, Toulouse School of Economics (France)

Thesis European Evaluators

Luis Miguel MILLER, Associate Professor, Oxford University, (Great Britain)

Augustín PÉREZ BARAHONA, Professor, Paris School of Economics (France)

Thesis Expert Evaluator

Pablo Coralio BALLESTER-PLA, Professor, University of Alicante, (Spain)

Editor: Editorial de la Universidad de Granada
Autor: Antonios Proestakis
D.L.: GR 485-2012
ISBN: 978-84-694-6941-5

UNIVERSIDAD DE GRANADA
FACULTAD DE CIENCIAS ECONÓMICAS Y EMPRESARIALES
DEPARTAMENTO DE TEORÍA E HISTORIA ECONÓMICA

ESSAYS ON ECONOMICS OF CULTURAL TRAITS

Antonios Proestakis

Dissertation Thesis of the doctorate program
Empirical Economics (Economía Empírica)

Defense date: 26 of July 2011

PhD Candidate:
Antonios Proestakis

Thesis director:
Professor Pablo Brañas Garza

ACKNOWLEDGEMENTS

I am very grateful to my advisor Professor Pablo Brañas Garza. I thank him for advising me on this research. He has pushed the progress of my research and has accompanied my intellectual development throughout this process with interest, care and attentiveness. He revealed to me the world of experimental economics and offer me all the necessary knowledge and tools for enjoying it.

I am very grateful to Professor Nikolaos Georgantzís. I thank him for always being next to me as as advisor, coauthor and most importantly as a friend. His guiding light attracted me from Greece to Spain and accompany me in all this difficult route. I specially thanking him for teaching me the Odyssey.

I thank very sincerely Professor Teresa García Munoz for treating me as her supervisee. Her econometric advises always were very useful and informative for the econometric analysis of this thesis. I also thank her for help me in dealing with administrative matters.

I thank my coauthors Vicente Calabuig and Gonzalo Olcina for introducing me in the world of “Intergenerational Cultural Transmission”and my coauthors in my first experimental study “Alcohol and Risk Aversion”for sharing with me this first experience. I especially thank Antonio Espín and Filippos Exadaktylos for their exceptional contribution on this paper.

I thank Professors Urs Fischbacher and Emanuel Petrakis for giving me the opportunity to work with them, as a visiting scholar, in the University of Konstanz and University of Crete respectively.

I am very grateful to my colleagues and professor in the Department of Economic Theory and History of the University of Granada for supporting me with useful comments during

the departmental seminars and in private discussions. I specially thank all the members of the experimental team of Granada and GLOBE who support me with their expert knowledge and advise. Most particularly I want to thank Ramn Cobo-Reyes, Natalia Jimnez, Juan A. Lacomba, Francisco Lagos, Ángel Solano, and Shoshana Neuman. I have special thoughts for the latter as she help me a lot with her useful comments on the first study of this thesis.

I also acknowledge financial support from the Regional Programs SEJ-02547, SEJ-023 and P07-SEJ-003155 of Junta de Andalucia.

I thank my friends for their company and support, despite all my travels and my relative unavailability. I have some special thoughts for Filippos Exadaktylos, who supported me in every possible way from the first moment of this doctorate, as a colleague, as coauthor and most importantly as a friend. I thank him for responding to all these roles in the best way and for working intensively for the creation of a great friendship.

Last but not least, I acknowledge the importance of the help and support that my family has given me. I am most particularly grateful to my mother for creating my dreams to my sister for making me believe in them and to my brother for help me to fulfill them. I finally thank my girlfriend Chrysi, for supporting me in all this stressful process and for withstanding the physical distance which was separating us for several years.

To my Family.

Abstract

Human beings are not “one-shot” decision making machines. Rather, their decisions are subject to what they carry over from their Economic, Biological and Cultural heritage. This thesis is an attempt to study these three domains of human heritage and their effect on an agents’ actual decisions in specific economic environments.

Within the biological domain, I focus on the role of obesity as a source of self-discrimination. Our experimental setting investigates whether self-reported obese people respond in a different way when faced with the opportunity of earning a positive amount of money. Significant lower money requests by obese people confirm our self-discrimination hypothesis, offering an additional explanation for the wage gap; Thus, it seems that obese people earn less not only because of discrimination against them but also because they themselves are less demanding. Two different explanations are suggested: obese people request less due to self-esteem vulnerability and/or due to some kind of a self-fulfilling prophecy.

Within the Economic domain, I focus on the interaction between endowment and wealth heterogeneity. After eliciting real out-of-lab wealth, we form 4-player groups playing an one-shot public good game with heterogeneous laboratory endowments. Endowing subjects according or against their real wealth gives rise to a series of interesting results. Endowment heterogeneity, lack of real relative wealth information and being “rich” both inside and outside the lab raise contributions. Finally, when eliciting subjects’ beliefs, we find out that only relatively “poor” subjects expect others to contribute more than what they actually are prepared to do themselves.

Finally, regarding the Cultural domain, in an overlapping generations trust game with punishment, where there is cultural transmission of preferences, we investigate the interaction and the evolution between the preferences for reciprocity of the allocator and the feasibility and willingness to punish hostile behavior by the investor. The long run behavior of this society which results from the stable steady states of the dynamics, characterizes different cultures. We focus on the effect of the punishment capacity of the society, as a major determinant for the successful implementation of a Fully Cooperative Culture leading to the social efficient outcome. Our main result states that if punishment capacity is high enough and its unity cost low, the economy will converge from any initial condition to an efficient cooperative equilibrium. Finally, when punishment capacity is endogenized the most efficient outcome is achieved faster and with higher probability, while it is erased any possibility of converging in the inefficient equilibrium.



Resumen

Los seres humanos no son máquinas que tomen decisiones instintivamente. Por el contrario, sus decisiones están sujetas a lo que llevan de su patrimonio económico, biológico y cultural. Esta tesis es un intento de estudiar estos tres ámbitos del patrimonio humano y sus efectos sobre las decisiones reales de los agentes en los ambientes económicos.

Dentro del ámbito biológico, me concentro en el papel de la obesidad como una fuente de auto-discriminación. Nuestro entorno experimental investiga si las personas que auto-reportan que son obesas responden de manera diferente cuando se enfrentan a la oportunidad de ganar una cantidad positiva de dinero. Solicitudes de dinero significativamente inferiores de las personas obesas confirman nuestra hipótesis de auto-discriminación, ofreciendo una explicación adicional para las diferencias salariales; Por lo tanto, parece que las personas obesas ganan menos, no sólo por la discriminación contra ellos, sino también porque ellos mismos son menos exigentes. Dos explicaciones distintas se sugieren: las personas obesas piden menos debido a la vulnerabilidad de sus autoestima y / o debido a algún tipo de profecía auto-cumplida.

Dentro del ámbito económico, me concentro en la interacción entre la dotación inicial y la riqueza heterogénea. Después que los sujetos se relevan sus fuera-de-laboratorio riqueza, formamos grupos de 4-personas que juegan el Juego de los Bienes Públicos recibiendo dotaciones iniciales que son diferentes. Dotar los sujetos según o en contra de su riqueza da lugar a una serie de resultados muy interesantes. Heterogeneidad de dotación, la falta de información sobre la riqueza relativa y ser “rico” dentro como fuera del laboratorio eleva las contribuciones. Por último, cuando se revelan las creencias de los sujetos, nos encontramos que solo los sujetos que son relativamente “pobres” esperan que los otros tienen que contribuir más de lo que realmente están dispuestos a contribuir por sí mismos.

Finalmente, respecto al ámbito cultural, en un juego de la confianza de generaciones traslapadas con castigo, donde hay transmisión cultural de las preferencias, se investiga la interacción y la evolución entre las preferencias de reciprocidad del asignador y la voluntad de castigar el comportamiento hostil por parte de los inversores. El comportamiento a largo plazo de esta sociedad resulta del estado estable de la dinámica, que caracteriza las diferentes culturas. Nos centramos en el efecto de la capacidad de castigo de la sociedad, como un factor determinante para la exitosa implementación de una cultura de máxima cooperación conduciendo en un resultado socialmente eficiente. Nuestro resultado principal declara que si la capacidad de castigo es suficientemente alta y su coste unitario suficientemente bajo, cualquier economía, independiente de las condiciones iniciales, se convergirá a un equilibrio eficientemente cooperativo. Cuando la capacidad

de castigo es endógena, el resultado eficiente se logra más rápido y con mayor probabilidad, mientras se desaparece cualquier posibilidad que la economía se converja en un equilibrio ineficiente.

CONTENT

Acknowledgements	i
Dedication	iii
Abstract	iii
Resumen	vii
Content	x
I. General Introduction	1
1. Introduction	2
II. Essays	15
2. Self-discrimination: A field experiment on obesity.	16
3. Accounting for real wealth in heterogeneous-endowment public good games	46
4. Intergenerational Trust Transmission: The effect of Endogenous Punishment	68

III. General Conclusion	115
5. Conclusion	116
IV. Resumen de los trabajos en Castellano	125
6. RESUMEN DE LOS TRES TRABAJOS EN CASTELLANO	126
V. Bibliography	129
7. Bibliography of Introduction	130
8. Bibliography of Essay 1	132
9. Bibliography of Essay 2	137
10. Bibliography of Essay 3	140
VI. Appendix	145
11. Appendices of Essay 1	146
12. Appendices of Essay 2	172
13. Appendices of Essay 3	179
14. Appendix of Conclusion	189
List of figures	191
Table of contents	194

PART I.

GENERAL INTRODUCTION

INTRODUCTION

1.1. GENERAL IDEA

The present thesis departs from the idea that the crucial factor in the way culture affects economic outcomes are *individual* preferences. Although full of idiosyncratic “noise”, individual preferences function as the mediating transmitters, the carriers of the messages in the cultural transmission process. The overall objective of the *Economics of Cultural Traits* is to shed light in this process, expose the interplay of its components and explain their causal relationships. The first two essays analyze experimentally the relationship between preferences and economic outcomes assuming pre-existing prevalent cultural traits. The third essay sets the theoretical framework which is competent to describe the entire inter-generational transmission of preferences resulting on a new, more experienced¹, culture with different preferences and consequently with different economic outcomes. Special attention is given on the role of punishing institutions in the process of the cultural transmission.

Traditionally, economists have focused only on the study of the effects of individual preferences on economic outcomes, leaving the primary role of culture mainly disregarded. At the same time, scholars from neighboring social sciences such as sociology and social psychology highlight the decisive role of culture in the construct and evolution of preferences and traits in a society. This absence comes at no surprise given the usual lack of communication between disciplines. However, in this case, what has also primary acted as a dispiriting

¹Even if the resulting preferences and economic outcomes of the new generation are exactly the same with the ones of the previous generation, still they differ in experience and therefore in prevalence strength.

factor was the lack of a solid and operational definition of culture.² The broad notion of culture made it difficult to design testable hypotheses. According to Greif 1994(8), 2001(9), without testable hypothesis, there is no role for culture in economics except perhaps as a selection mechanism among multiple equilibria.

In the last decade, however, a number of empirical economic studies (Guiso, Sapienza and Zingales, 2004(10), 2006(106), Tabellini, 2010(119), Fernández 2008(7)), using extensive (multi-national) datasets and advanced statistical software managed to attract the interest of economists. These well-published studies have identified systematic differences on the way culture affects economic variables. Their results have also found support on laboratory and natural experimental studies (Henrich et al., 2001(12), Botticini and Eckstein, 2005(6), Greif, 1994(8)).

Quite interestingly however, consensus for the definition of culture has not been achieved even among economists. Nevertheless, the definition given by Merriam Webster dictionary seems to be the meeting point, at least among the majority of economic studies, including the present one³: Culture is *the intergraded pattern of human knowledge, belief and behavior that depends upon the capacity for learning and transmitting knowledge to succeeding generations and the customary beliefs, social forms, and material traits of racial religious or social group; (and) the set of shared attitudes, values, goals, and practices that characterizes an institution or organization.*

The above definition also introduces the notion of cultural transmission that consists the focus of the third part of this thesis. Bisin and Verdier in their seminal paper (2001a(92)) on intergenerational cultural transmission, give the following definition: *The transmission of preferences, beliefs, and norms of behavior which is the result of social interactions across and within generations is called cultural transmission.* They also make a clear distinction between genetic evolution and cultural transmission⁴, although they accept both as main

²There is no agreed upon definition. By 1950, Kroeber and Kluckhohn (1952) (13) provided over 150 definitions.

³In the third essay it is also used a more technical definition of the notion of culture, first used by Rob and Zemsky (2002) (117).

⁴For a discussion on the distinction of these two notions, typically referred to as nature/nurture, see Robson

determinants for the formation of preference beliefs and norms.

Departing from the aforementioned definitions, in this thesis I investigate the relation among cultural traits, preferences and economic decisions and outcomes. The first two essays analyze, experimentally, the relationship between preferences and economic decisions and outcomes assuming pre-existing prevalent cultural traits. While the first one focus on the effect of a Biological factor (obesity), the second one analyzes the impact of an economic factor (wealth) on the economic outcomes. Finally, the third essay sets the theoretical base that combines all types of relations and explains how trust is transmitted through generations. As a general aftermath, rather than a general approach to the issues of Biological, Economic and Cultural past as sources of present decision making, this thesis has paid tribute to three concrete aspects of our biological, economic and cultural heritage as coordinates of our starting point as individual decision makers in specific economic domains. A brief description of the three main parts of this thesis follows.

1.2. OBESITY AS A SOURCE OF SELF-DISCRIMINATION.

Obesity is an obvious appearance characteristic which severely stigmatizes individuals and provoke multiple forms of prejudice and discrimination against them in several social environments (see Puhl and Heuer(52) for an extensive review). Focusing on the field of economics, numerous empirical studies report the negative effects of obesity (measured by body mass index) on labour success measured by wages and employment rates (Atella et al.(18), Cawley(25), (26); Cawley and Danziger(27), Han et al.(37)).⁵

In this study, we propose that part of the aforementioned wage gap could be attributed to the differences between obese and non-obese people in their initial requests. Although there

and Samuelson (2010) (15)

⁵Cawley(25) finds that for white females, an increase of 64 pounds above average weight was associated with a 9% decrease in wages. Han et al.(37) find that the negative relationship between the BMI and wages is larger in occupations requiring social interactions and for older people. Atella et al.(18) show that cultural, environmental or institutional settings do not seem to be able to explain differences among countries on the wage-obesity relationship, leaving room for a pure discriminatory effect hypothesis.

1.2. OBESITY AS A SOURCE OF SELF-DISCRIMINATION.

could be other explanations for the gap across weight, we consider that initial requests, or initial offers, are important because they can serve as anchors in the negotiation, influencing subsequent offers and final agreements. The importance of the *adjustment from an anchor* in making judgments under uncertainty was firstly described by Tversky and Kahneman(59), while several empirical and experimental studies in the negotiation-bargaining literature have established its validation (Galinsky & Mussweiler(31), Chertkoff et al.(28),Liebert et al.(42), Ritov(53)).

According to our experimental setting, subjects, after filling out a questionnaire, are asked for *how much money they would like to request as a compensation for the effort they made to complete this particular questionnaire and for the information they provided us*. We consider that this open-ended question, inspired by Greig(35), does have an implementation on labor markets as it simulates the commonly asked employers' question to the job candidates: "How much money would you like to receive for doing this particular job?" Moreover, subjects have to complete out our research questionnaire, a task which could correspond to the specific task that every employee has to accomplish in his/her job. Therefore, in contrast with the majority of previous experimental labour market studies, we manage to create work environment conditions without using any artificial framing⁶.

To the best of our knowledge, there is no any other study investigating the difference in initial requests between obese and non-obese persons. Nevertheless, across gender literature, one can find many papers demonstrating that men make significantly larger salary requests than women, a fact that leads to a lower first salary and consequently in a more modest career advancement (Gerhart(33), Rosenbaum(56), Barron(19), Greig(35)). There are two main explanations given in this specific literature. Major (43) argued that differences in men's and women's entitlement were due to several factors: group-based social inequities, intra-group and intra-personal comparison biases, group differences in reference standards, legitimizing beliefs and attributions and group differences in evaluations of pre-conditions.

⁶Typically, experimental studies ask participants to evaluate a fictional applicant's qualifications for an hypothetical job, where his or her weight has been manipulated (through written vignettes, videos, photographs or computer morphing).

Other researchers (Wade(61)) have argued that socialization pressures have caused women to assert themselves less.

These arguments are compatible with the main findings of our study if it is considered that obese people, like women, belong to a group which has been treated differently and discriminated in the working environment. Furthermore, taking into account that weight-related stigmatization is considered as one of the most severe stigmas⁷, two further socio-psychological oriented explanations for initial requests' disparities across weight are suggested.

The first one is based on self-fulfilling prophecy theory (Merton(44)). Applying this theory on obesity discrimination in the working environment, we elicit a process with three separate stages: *1) Employers⁸ form false beliefs for obese employees. 2) Employers develop differential treatment towards obese employees. 3) Obese workers' behavior is shaped in an expectancy-consistent manner.*

The second explanation for the difference in initial requests between obese and non-obese persons is a bit more complicated since a third condition, self-esteem, is incorporated between obesity and initial requests. Obese people are more vulnerable to lower self-esteem which, in turn, is correlated with lower initial wage requests and, by extension, with lower earnings. Regarding obesity and self-esteem, there are several studies (Biro et al.(21), Carr&Friedman(24), Hesketh et al.(40), French et al. (49) and by Wardle & Cooke(63)) reporting a negative correlation. As far as the relation between self-esteem and earnings is concerned, early childhood intervention programs provide indisputable evidence for their positive correlation. These programs raised lifetime earnings by improving students' social skills and motivation (see Heckman(39)).

Therefore, the explanation we suggest, and the main contribution of the present study, is that obese people, due to low self-esteem or/and due to self-fulfilling prophecy, feel that they

⁷Due to visibility and perceived controllability of the weight-related stigmatized condition.

⁸Since there is evidence (Wang et al.(62)) that obese people, unlike other minority groups, appear to hold negative attitudes toward ingroup members (weight bias internalization), no distinction between obese and non-obese employers is necessary to be made.

1.3. WEALTH HETEROGENEITY IN PUBLIC GOOD GAMES

do not deserve as much as a non-obese and consequently they form lower, if any, requests. We conclude though, that one of the main reasons why obese people end up with lower earnings is simply because they do not ask for more.

Finally, following the same argumentation and based on prior evidence in the field of labor economics regarding attractiveness and gender, we also suggest that initial wage requests are one of the main reasons of the so-called “beauty premium” (Hamermesh & Biddle(36)) and gender gap (Goldin(34), O’Neill (47),(48)) in wages.

The main results of this study are the following:

- 1:** “Obese” subjects request significantly less money than "non-obese" subjects.
- 2:** “Obese” subjects (significantly more times) do not request any money at all as compared to "non-obese" subjects.
- 3:** Among subjects who request a positive amount of money, “obese” subjects request significantly less than “non- obese” subjects.
- 4:** Subjects’ beauty has no significant effect on money requests (either on amount or frequency).
- 5:** Although there is no significant gender effect on subjects’ money requests (either on amount or frequency), there is evidence that the negative association between *money*, and *dobese* is mainly due to the participation of females in the sample.

1.3. WEALTH HETEROGENEITY IN PUBLIC GOOD GAMES

9

Wealth heterogeneity is present in several real-life contexts in which people voluntarily contribute to a public good. However, the effect of wealth disparities on individual contributions to a public good is not fully understood. Similarly, the role of public information

⁹Based on the paper:”Accounting for Real Wealth in heterogeneous-endowment Public Good Games”coauthored with Nikolaos Georgantzis

regarding these disparities is also far from clear. For example, there is a general tendency to introduce transparency on people's true income as a means of reducing tax evasion, while, as we show in this paper, the effectiveness of this policy may not be as straightforward as it sounds.

So far, experimentalists wishing to study the effects of wealth inequality on public good contributions use endowment heterogeneity as the laboratory analogous of real-life wealth differences. For example, Cherry et al (2005) (74) and Buckley and Croson (2006) (69) adopt two different methods of inducing endowment heterogeneity. The former compares windfall to earned endowments, whereas the latter considers a subject's cumulative profits from earlier periods as a source of wealth differences. The availability of public information on endowment heterogeneity is studied by Anderson et al. (2008) (66). Chan et al. (1996) (72) use windfall heterogeneity in a non linear setting (no free ride equilibrium) and Chan et al. (1999) (73) also introduce heterogeneity in subjects' private value of the public good. Fisher et al. (1994) (76) focus only on the private value of the public good. Ledyard (1995) (77) reviews various factors affecting public good contributions. The only paper which controls for real income heterogeneity is Cardenas (2003) (71) who elicits contributions to a real public good (not a laboratory one). However, this is a field experiment and controlled endowment heterogeneity is not applicable. Therefore, the interplay between laboratory endowment and real income heterogeneity has not been studied so far. However, if we admit that overall wealth affects contribution levels, it is reasonable to ask how endowment heterogeneity induced in the lab interacts with wealth heterogeneity outside the lab in order to determine a subject's contribution.

In the second part of the thesis, we address this issue. Our design is based on a pre-play elicitation of our subjects' disposable income which is then used to form specific heterogeneous four-player combinations of wealth and endowment heterogeneity. We also consider the alternative of random endowment heterogeneity which corresponds to the usual practice of not controlling for real-life income when inducing endowment heterogeneity in the lab.

1.3. WEALTH HETEROGENEITY IN PUBLIC GOOD GAMES

Furthermore, we study the effect of knowing one's relative position in the group in terms of real wealth, in isolation from the income and endowment heterogeneity effects themselves.

The elicitation of real wealth is a rather challenging task. This is mainly due to the fact that, generally speaking, information on real income or wealth should be used jointly with an individual's spending needs and saving habits. We tackle this issue by using a rather homogeneous subject pool of economics students at the University of Crete with little if any saving behavior. Our strategy was aimed at identifying both personal and indirect sources of the student's disposable income, like parents' wealth and that of other family members supporting the student with monetary gifts in a relatively regular basis. The final index of a subject's wealth is a composite measure of parents' salaries and monthly allowances coming from other family assets.

Our main findings are the following. Subjects contribute a lower percentage of their laboratory income if they receive the high endowment. Furthermore, contrary to previous results that report negative (i.e. Anderson et al., 2008(66), Cherry et al. 2005(74), Bagnoli and McKee (1991) (67)) or no effect (Marwell and Ames 1979(78),1980(79), Sadrieh and Verbon, 2004(83)) of inequality, we find that group heterogeneity increases the level of voluntary contributions. On the contrary, the availability of information on real wealth heterogeneity reduces contribution levels and the relative size of contributions as a percentage of laboratory endowments. Furthermore, out-of-lab wealth may have a positive effect on contributions, as long as a rich subject receives the high endowment and a poor subject the low one. People who are "rich" both in and out of the lab contribute a significantly higher percentage of their endowment compared to people who are "poor" in and out of lab. Finally, looking at beliefs, poor subjects tend to adopt the most irresponsible and selfish attitude of someone who expects others to contribute more than what he actually is prepared to do himself.

1.4. A THEORETICAL APPROACH ON THE INTERGENERATIONAL TRANSMISSION OF TRUST.

While it is well established in the literature that trust is one of the main factors influencing positively the economic activity and efficiency of a society (Knack and Keefer, 1997(107), Knack and Zak, 2001(108)), different levels of trust are observed around the world. Besides the fact that all societies employ public policies in order to improve the levels of trust, and thus, the economic outcomes, these differences keep persistent. It is therefore reasonable to query why societies develop different levels of trust through generations although the punishment mechanisms that are imposed by governments and their respective institutions are somehow similar. Finally, inspired by the recent political changes taking place mainly in North African countries, we analyze whether different regimentation schemes and their consequent transition could possible has an impact on societies' trust and outcomes.

In order to study trust, we use an extended version of the well-known trust game, first introduced by Berg et. al (1995) with an additional punishment stage; in the third punishment stage, investor decides which proportion (if any) of allocator's total wealth is willing to destroy at a given unitary cost (z).

Departing from the point that existing "cooperative" preferences within a society are not sufficient to obtain and maintain high levels of trust, the central focus of this study is to analyze the main determinants of punishing institutions which could possibly result on higher levels of trust and consequently on higher economic outcomes. Apart from the well-established in the literature impact of punishment cost on "cooperative" outcomes (Rigdon, 2009(115), Nikiforakis, 2008(112), Gintis, 2008(105), Carpenter, 2007(95)), we pay special attention on the effect of punishment capacity, which is defined as the maximum proportion of defectors' surplus which can be destroyed by cooperators at a given cost. In a more free context, punishment capacity can be considered equal to institutions' efficiency; even if agents are willing to destroy all the surplus of the defectors, institutions do not offer such option either

1.4. A THEORETICAL APPROACH ON THE INTERGENERATIONAL TRANSMISSION OF TRUST.

deliberately (bribing, corruption, etc.) or unintentionally (bureaucracy, incapacity, etc.).

Based on Olcina and Calabuig (2008) (113), we study the intergenerational transmission of two distinct types of preferences, selfish or alternatively inequity-averse, which might affect the cooperating or defecting outcomes in an intergenerational TGP. More specifically, in each period and each population (investors or allocators) there is a fraction of selfish agents and a fraction of reciprocal agents. The distribution of preferences in each population evolves according to a process of cultural transmission which combines direct transmission from parents with oblique transmission from the society (Cavalli-Sforza and Feldman, 1981(96),, Boyd and Richerson, 1985(90)). Parents make a costly decision on education effort trying to transmit their own preferences (Bisin and Verdier, 2001). If they do not succeed, children acquire preferences from the social environment. In contrast with the basic assumption of the aforementioned seminal paper by Bisin and Verdier (2001) (92), where oblique transmission takes place in society at large, we assume *cultural isolation*. Investors' (allocators') offspring are socialized, either by their parents or by other adult investors (allocators).

As our primary result concludes that punishment capacity (λ^*) is a very crucial determinant for achieving “cooperative” outcomes through generations, we also consider two different implementation mechanisms (regarding capacity), representing two different political regimes, an authoritarian and a democratic.

The interplay among the aforementioned implementation mechanisms of λ^* , the exogenously determined parameters' values of the model (i.e. punishment cost (z), inequity averse parameters (α, β)) and the different departing points of a generation (characterizing the distribution of its preferences) leads to a variety of results and conclusions regarding actions, strategies, distributions of preferences and equilibriums. However, it is proven that any given generation is going to be driven into (at least) one stable steady state of the cultural dynamics where the same Perfect bayesian Equilibrium of the TGP is played. Adhering the notion of culture by Rob and Zemsky (2002) (117), we define three *cultures* which can possibly persist in the long run.

First, when the capacity of punishment is sufficiently high and the cost of punishment is sufficiently low, it is obtained what we denote as a Fully Cooperative Culture (FCC). Second, there is a Quasi Cooperative Culture, with a both intermediate capacity of punishment and an intermediate cost of punishment, in which both types of investors choose to make investments, but selfish allocators offer low return while reciprocal allocators offer high rewards. Finally, there is a third culture, the Inefficient Separating Culture (ISC), characterized by a low capacity of punishment and/or a high cost of punishment, in which the selfish investor chooses to make the investment and the reciprocal investor chooses not to make it .

Finally, the endogenous choice of punishment capacity have several impacts on the determination of the final prevalent culture.

1. The ISC is no longer feasible. With the election of the adequate λ^* , all agents will end up either to FCC or to QCC, no matter the initial distribution of preferences or the the exogenous parameters of the model.
2. The dynamical convergence to FCC is achieved faster or even immediate. All agents are coming closer to FCC as soon as high λ^* is the outcome of the election. Moreover, when inequity averse are more than selfish investors passing from ISC or QCC to FCC is immediate.
3. Some generations trapped into QCC will never manage to escape even with endogenous λ^* . This is the case when selfish are more than inequity-averse investors.
4. Given that agents are short-sighted, some generations, in their attempt to escape from ISC, will also be trapped into QCC.

A first conclusion, which can be drawn from the above observations, is that the “democratization”, leads to the election of sufficient high punishment capacity which in its turn affects positively the level of trust and therefore the efficiency of a society. Nevertheless, even an authoritarian planer could possibly manage to achieve efficiency by imposing high punishment capacity in the society. Our argument here is that the punishment capacity in our model

1.4. A THEORETICAL APPROACH ON THE INTERGENERATIONAL TRANSMISSION OF TRUST.

represents not the “nominal” capacity stated by any planer (democratic or no) but the actual one which is commonly, or by the majority, believed and accepted. Given that authoritarian or totalitarian regimes usually are not by majority approved while at the same time a minority is treated favorably, we believe that the actual punishment capacity is small, even if it is declared high.

PART II.

ESSAYS

SELF-DISCRIMINATION: A FIELD EXPERIMENT ON OBESITY.

Abstract

While it is well-established in the literature that obese people are discriminated against in the working environment, little is known about their own actual behavior. Our experimental setting investigates whether these potentially discriminated people respond in a different way when faced with the opportunity of earning a positive amount of money. Significant lower money requests by obese people confirm our self-discrimination hypothesis, offering an additional explanation for the wage gap; Thus, it seems that obese people earn less not only because of discrimination against them but also because they themselves are less demanding. Two different explanations are suggested: obese people request less due to self-esteem vulnerability and/or due to some kind of a self-fulfilling prophecy. Results are not confirmed when applying the same approach to “beauty” and “gender”, two features that are also often associated with wage discrimination.

2.1. INTRODUCTION

Obesity is an obvious appearance characteristic which severely stigmatizes individuals and provoke multiple forms of prejudice and discrimination against them in several social environments (see Puhl and Heuer(52) for an extensive review). Focusing on the field of economics, numerous empirical studies report the negative effects of obesity (measured by body mass index) on labour success measured by wages and employment rates, (Atella et al.(18), Cawley(25), (26); Cawley and Danziger(27), Han et al.(37))¹, a result, which is also supported across european studies²(Brunello and D' Hombres(22),Garcia and Quintana-Domeque(32)). Furthermore, in more recent studies, where more complex measures of obesity are employed, the general result of obesity discrimination on the working environment still holds, although weaker³(Burkhauser and Cawley(23), Johansson et al.(41), Wada and Tekin(60)). Finally, experimental studies also provide evidence on obesity discrimination especially regarding the hiring process. In a recent meta-analysis on weight discrimination in employment settings by Roehling, Pilcher and Bruce(54), it was demonstrated that overweight job applicants and employees were evaluated more negatively and had more negative employment outcomes (hiring recommendations, qualification/ suitability ratings, disciplinary decisions, salary assignments, placement decisions, and coworker ratings) compared to non-overweight counterparts.

In this study, we propose that part of the aforementioned wage gap could be attributed to the differences between obese and non-obese people in their initial requests. Although there could be other explanations for the gap across weight, we consider that initial requests, or

¹Cawley(25) finds that for white females, an increase of 64 pounds above average weight was associated with a 9% decrease in wages. Han et al.(37) find that the negative relationship between the BMI and wages is larger in occupations requiring social interactions and for older people. Atella et al.(18) show that cultural, environmental or institutional settings do not seem to be able to explain differences among countries on the wage-obesity relationship, leaving room for a pure discriminatory effect hypothesis.

²Brunello and D' Hombres(22) observes that a 10% increase in the average BMI reduces the hourly wages of males by 1.9% and females by 3.3% while Garcia and Quintana-Domeque(32) finds a negative correlation between wages and obesity, ranging from -2 to -10 % only for women.

³Burkhauser and Cawley(23) claim that total body fat is negatively correlated with employment for some groups. Johansson et al.(41) find that only waist circumference has a negative association with wages for women. Wada and Tekin(60) report that body fat is associated with decreased wages for both males and females while they also present evidence suggesting that free fat mass is associated with increased wages.

initial offers, are important because they can serve as anchors in the negotiation, influencing subsequent offers and final agreements. The importance of the *adjustment from an anchor* in making judgments under uncertainty was firstly described by Tversky and Kahneman(59), while several empirical and experimental studies in the negotiation-bargaining literature have established its validation (Galinsky & Mussweiler(31), Chertkoff et al.(28),Liebert et al.(42), Ritov(53)). According to our experimental setting, subjects, after filling out a questionnaire, are asked for *how much money they would like to request as a compensation for the effort they made to complete this particular questionnaire and for the information they provided us*. We consider that this open-ended question, inspired by Greig(35), does have an implementation on labor markets as it simulates the commonly asked employers' question to the job candidates: "How much money would you like to receive for doing this particular job?"Moreover, subjects have to complete out our research questionnaire, a task which could correspond to the specific task that every employee has to accomplish in his/her job. Therefore, in contrast with the majority of previous experimental labour market studies, we manage to create work environment conditions without using any artificial framing⁴.

To the best of our knowledge, there is no any other study investigating the difference in initial requests between obese and non-obese persons. Nevertheless, across gender literature, one can find many papers demonstrating that men make significantly larger salary requests than women, a fact that leads to a lower first salary and consequently in a more modest career advancement (Gerhart(33), Rosenbaum(56), Barron(19), Greig(35)).There are two main explanations given in this specific literature. Major (43) argued that differences in men's and women's entitlement were due to several factors: group-based social inequities, intra-group and intra-personal comparison biases, group differences in reference standards, legitimizing beliefs and attributions and group differences in evaluations of pre-conditions. Other researchers (Wade(61)) have argued that socialization pressures have caused women to assert themselves less.

⁴Typically, experimental studies ask participants to evaluate a fictional applicant's qualifications for an hypothetical job, where his or her weight has been manipulated (through written vignettes, videos, photographs or computer morphing).

2.1. INTRODUCTION

These arguments are compatible with the main findings of our study if it is considered that obese people, like women, belong to a group which has been treated differently and discriminated in the working environment. Furthermore, taking into account that weight-related stigmatization is considered as one of the most severe stigmas⁵, two further socio-psychological oriented explanations for initial requests' disparities across weight are suggested.

The first one is based on self-fulfilling prophecy theory (Merton(44)). According to Merton(44), *a self-fulfilling prophecy occurs when a perceiver's false belief influences the perceiver's treatment of a target which, in turn, shapes the target behavior in an expectancy-consistent manner. [...] The self-fulfilling prophecy has historically been linked to social problems by virtue of its ability to create social inequality, decrease academic achievement of minority students, and fuel discrimination.*

Applying the above theory to obesity discrimination in the working environment, three separate stages can be distinguished: 1) *Employers⁶ form false beliefs for obese employees.* Research to date (see Puhl & Heur(52) for an extensive review) suggests that the most common stereotypes about obese employees include views that they are less hard-working, less perseverant, less conscientious, less agreeable, less emotionally stable, less extraverted etc. than their normal-weight counterparts. 2) *Employers develop differential treatment towards obese employees.* As it has already been described above, obese workers face stereotypical attitudes and disadvantages in wages and in other job-related aspects like hiring, promotions and job termination. 3) *Obese workers' behavior is shaped in an expectancy-consistent manner.* Expecting lower wages, obese-workers request or they are willing to accept lower wages. Exactly this last stage consists the objective of our study.

Piketty's(51) study gives a possible socio-economic interpretation of self-fulfilling prophecy theory by considering that the well-known model of statistical discrimination can be sup-

⁵ Due to visibility and perceived controllability of the weight-related stigmatized condition.

⁶ Since there is evidence (Wang et al.(62)) that obese people, unlike other minority groups, appear to hold negative attitudes toward ingroup members (weight bias internalization), no distinction between obese and non-obese employers is necessary to be made.

ported by the aforementioned theory as follows: since employers expect lower-class agents to be less qualified for top jobs, they promote them less often, so that lower class agents are discouraged and adopt a behavior that validates the employers' expectations. Following the same reasoning, we suggest that obese agents adopt a behavior that validates the employers' expectations by requesting lower salaries.

The second explanation for the difference in initial requests between obese and non-obese persons is a bit more complicated since a third condition, self-esteem, is incorporated between obesity and initial requests. Obese people are more vulnerable to lower self-esteem which, in turn, is correlated with lower initial wage requests and, by extension, with lower earnings.

Regarding obesity and self-esteem, there are several studies (Biro et al.(21), Carr&Friedman(24), Hesketh et al.(40), French et al. (49) and by Wardle & Cooke(63)) reporting a negative correlation⁷. Closer to our finding is Miller and Downey(45) who conclude in their meta-analysis that the "heavyweight people do have somewhat low self-esteem, but that the relation is stronger for people who perceive themselves as heavyweight than for people who actually are heavyweight, and thus likely to be perceived as heavyweight by other". In our study, we also preferred to use self-reports for measuring subjects' obesity level.

As far as the relation between self-esteem and earnings is concerned, early childhood intervention programs provide indisputable evidence for their positive correlation. These programs raised lifetime earnings by improving students' social skills and motivation (see Heckman(39)). Moreover, in two experimental studies investigating the relation between height and earnings (Persico et al.(50)) and between attractiveness and earnings (Mobius and Rosenblat(46)), the negative relation between self-esteem and earnings is also confirmed. While in these studies it is not clear why low self-esteem people end up with lower earnings,

⁷In a nationally representative study of over 3000 adults, Carr & Friedman(24) find that obese individuals report lower levels of self-acceptance than normal-weight persons, which is fully mediated by perceptions of weight discrimination. Along the same lines Biro et al.(21) report that BMI is an important predictor of self-esteem on a 2379 sample of 9 and 10 years old girls while Hesketh et al.(40) find that obesity/overweight precedes low self-esteem in a study of 1157 elementary school children in Australia. In the same direction, but more moderated, are the results of the two comprehensive reviews of self-esteem and obesity in youths by French et al. (49) and by Wardle & Cooke(63).

2.1. INTRODUCTION

a remarkable study by Baumeister et al.(20) concludes that occupational success may boost self-esteem rather than the reverse. However, in the same study an important exception is mentioned; high self-esteem facilitates persistence after failure, a fact that can be translated into a greater academic and occupational success over the long term.

Therefore, the explanation we suggest, and the main contribution of the present study, is that obese people, due to low self-esteem or/and due to self-fulfilling prophecy, feel that they do not deserve as much as a non-obese and consequently they form lower, if any, requests. We conclude though, that one of the main reasons why obese people end up with lower earnings is simply because they do not ask for more.

Finally, following the same argumentation and based on prior evidence in the field of labor economics regarding attractiveness and gender, we also suggest that initial wage requests are one of the main reasons of the so-called “beauty premium” (Hamermesh & Biddle(36)) and gender gap (Goldin(34), O’Neill (47),(48)) in wages. Although, several worth-mentioned experimental studies (Solnick & Schweitzer (58), Andreoni & Petrie(17), Eckel & Wilson(30), Mobius and Rosenblat(46), Croson and Gneezy(29))⁸ have demonstrated the positive relationship between beauty/male and earnings across different bargaining settings (ultimatum, public good, trust game, labor market experiments), no study has found that “privileged” groups form higher initial requests compared to discriminated ones.

The main advantage of our experimental design over the aforementioned ones is that we perform a “non-interactive” game, preventing any potential influence between subjects. In this way, our subjects’ requests are not depended on other subjects’ characteristics (personality or appearance) and actions. However, neither did we find any correlation between

⁸Solnick & Schweitzer (58) rejected the hypothesis that attractive people and men will demand more than unattractive people and women in an ultimatum game but reported higher final payoffs for both “privileged” types. In a recent public goods experiment, Andreoni & Petrie(17) report that higher payoffs for attractive people and females are not due to differential behavior by attractive people and females but due to how others respond to beauty and gender. Moreover, Eckel & Wilson(30) found that attractive people are trusted at higher rates under a trust game framework. Finally, Mobius and Rosenblat(46) use a labor market experiment to decompose the beauty premium. They found that employers wrongly expected that physically attractive workers would perform better at their jobs. Finally, there are even more experimental studies highlighting a clear gender effect on behavior and payoffs(see Croson and Gneezy(29) for an extensive review).

beauty/gender and initial requests.

To sum up, the central issue of this experimental study is expressed through three basic questions:

- Do “obese” people, who self-report a higher-than-median level of obesity request less money than “non-obese” people ?
- Do “beautiful” people, who self-report a higher-than-median level of beauty request more money than “non-beautiful” people?
- Do women request less money than men?

The study is organized as follows: the experimental methods are described in detail in section 2, while the data and results are presented in section 3 and 4, respectively. Finally, section 5 concludes with a discussion of the results.

2.2. EXPERIMENTAL METHODS

One⁹ of the most important advantages of this research project is the fact that we conduct an economic field experiment with quite a large sample (269 subjects) consisting of various types of people from different socioeconomic backgrounds. In order to achieve this aim, 27 mediators-interviewers¹⁰ were fully trained to recruit subjects and conduct the experiment. All of the subjects were students enrolled in the course titled “Economic Analysis of Collective Relations” (2007) taught at the University of Granada who were interested in furthering their studies beyond the diploma level to obtain a B.A.¹¹. As a result, 27 people of different ages (20-60 years of age) and socioeconomic backgrounds were enrolled in this particular

⁹Detailed instructions for the whole experimental process are described in Appendix A. Questionnaires Q1 and Q2 are provided in Appendix G and H, respectively.

¹⁰We are especially grateful to the 27 students enrolled in the course titled “Economic Analysis of Collective Relations” (2007) at the University of Granada for helping us to conduct the experiment.

¹¹Under the Spanish legislation on education, students who have obtained a university diploma (which requires 3 years of study) may continue their studies to obtain a B.A. (which requires 4 years of study) by undertaking additional courses.

course. None of the mediators had any past experience in experimental economics, while their participation in the experiment as “interviewers” solely had a pedagogical aim¹².

2.2.1. STAGE 1: MEDIATORS’ TRAINING

Mediators were trained for a total of six hours. Training included a general description of experimental economics with special reference made to basic experimental protocols. Additional instructions regarding this specific experiment were given in detail. Finally, each mediator was asked to recruit 10 subjects to participate in an economic experiment within one week’s time. We also clearly stated (especially for the mediators who were also workers) our preference for employed subjects and a balanced subject pool regarding gender. After the first week, the mediators were asked to submit a list with the names of the 10 subjects they had recruited¹³.

2.2.2. STAGE 2: QUESTIONNAIRES AND IMPLEMENTATION

The second stage of the experiment began with mediators’ answers to questionnaire Q1, which was used in this phase to check that their subjects were real people. After completing Q1, the mediators received ten Q2 questionnaires and ten envelopes¹⁴, which they delivered to their subjects.

The first two parts of Q1 coincide with the first two parts of Q2. The only difference between the two questionnaires is that the questions on Q1 were answered by each of the 27 mediators 10 times to describe each of their 10 subjects, while the questions on Q2 were self-reported and therefore only answered one time by each of the 269 subjects. The following diagram shows the general structure of questionnaires Q1 and Q2.

¹²Upon completion of the course, the students were awarded a grade for a presentation on the results/conclusions obtained from the data.

¹³In order to protect the subjects’ identities, the mediators were asked to codify the names so that they would be recognizable only by the corresponding mediator and no one else

¹⁴The envelopes bore the seal of the University of Granada and were used to preserve subjects’ anonymity from the monitors.

Figure 2.1.: Diagram 1:Questionnaires

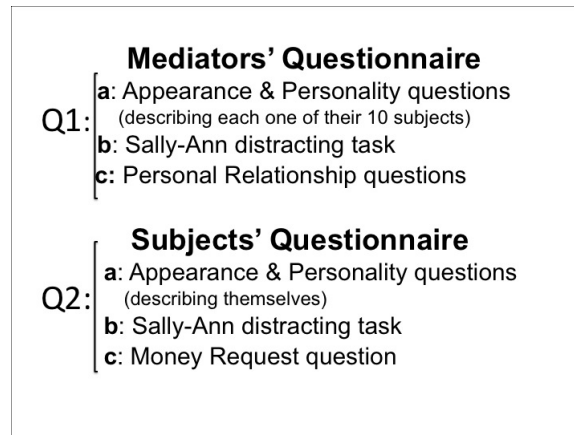

In the first part of the questionnaire given to the subjects, Q2a, the subjects were requested to answer 4 Likert questions about their appearance, namely *beauty*, *obesity*, *height* and *manner of dress*, and five Likert questions about their personality characteristics, specifically *ambition*, *self-confidence*, *sociality*, *creativeness* and *benevolence*. Nevertheless, only *beauty* and *obesity* as explanatory variables and only *ambition* and *self-confidence* as control variables are used. The remaining questions were used to distract subjects' attention from the real experimental objectives. For this same reason, an adjusted version of the Sally-Ann task (Wimmer & Perner (64)) was included in the second part of the subjects' questionnaire, Q2b. The Sally-Ann task is a psychological test which enables a series of images (see Appendix G).

Finally, while the third part of the mediators' questionnaire, Q1c, simply describes the personal relationship between the mediators and each of their subjects, the third part of the subjects' questionnaire, Q2c, actually consists the dependent variable of our research project. In this part, subjects were asked to reveal *how much money they would like to request as a compensation for the effort they made to fill out this particular questionnaire and for the information they provided us*. It was also clarified that the Spanish Research Council had provided a limited amount of money for this particular project. Q2 continues by asking subjects' to give their name and home address so that the researchers could send the subjects

the money they requested¹⁵.

Moreover, participants were assured about their personal data protection through the Law on the Protection of Personal Data. Finally, at the end of the Q2 questionnaire, the subjects were asked if they would be willing to participate in another experiment in the near future.

The second stage of the experiment concluded by instructing mediators to provide their subjects with delicate hints about how the payment would be made. In short, they “must” assure their subjects that they are truly going to receive a positive amount of money if they ask for it. Moreover, it was emphasized that only those subjects who provide their home address would be paid¹⁶. The mediators were also instructed to inform their subjects that the budget for this particular project was small and that the researchers were only willing to pay subjects according to the real value of their effort¹⁷. Finally, the mediators were given two weeks to administer the Q2 questionnaires to their subjects and return the completed questionnaires.

2.2.3. PAYMENTS

Finally, the third stage of the experiment began at the moment that the mediators submitted the Q2 questionnaires that had been completed by their subjects. The questionnaires were submitted in sealed envelopes. As regards the payment process, the mediators preferred to receive subjects’ payments on their behalf instead of mailing the money to them. To this end, the interviewers were asked to submit within two weeks time signed copies of the identity cards of the subjects who had requested money in the question in part “c” of questionnaire Q2. Payments were made two weeks later according to the following rule: “Subjects who request 10 euros or more, will be paid 10 euros. All the rest will receive the exact amount of their request.” Finally, of the 154 subjects who requested payment, only the 89 subjects who

¹⁵This was also another way to convince the subjects that we were truly willing to pay them the money they requested.

¹⁶This mechanism is also used in order to ensure the researchers that the participants were real people and not simply made up by the mediators.

¹⁷We clarified this point using the following wording: “Obviously, we are not going to pay anyone 1 million euros for filling out a questionnaire.”

provided copies of their identification card were paid. The total cost of the project was 854 euros .

2.3. DATA CONSIDERATIONS

In this section, we begin our analysis by describing the special characteristics of the dataset collected during the experimental process. In most cases, the variables used in our analysis are generated out of the raw data, without any intervention. However, in the case of the dependent variable *money*, it was necessary to transform the initial raw variable.

The dependent variable under consideration is *the amount of money that subjects requested in compensation for the effort they made to fill out the particular questionnaire and for the information provided us*. Despite the fact that the variable *money* is initially a continuous variable, we have to take into account three special characteristics of this variable, especially since regression analysis is to be applied:

1. 42.75% of subjects requested 0 euros¹⁸,
2. the value of the variable has a very wide range: 4.46% of the subjects requested more than 250 euros, while one subject requested 62,000 euros and another one asked for an infinite amount of money, and
3. there are several focal points (apart from 0) such as 10, 20, 30, 50, 100 which have frequencies of more than 5% each.

Therefore, treating *money* as an ordinary continuous variable is not so convincing. Moreover, we realized the need to not exclude extreme values from our regressions since they are of special interest from a theoretical point of view. Asking for an infinite amount of money is the Nash equilibrium of such a game, as the participant assures that he/she will receive the highest amount of money regardless of what the other subjects request.

¹⁸Blank-answers are also included in 0 requests.

2.3. DATA CONSIDERATIONS

Instead, it is more convincing to assume that all the subjects who ask for extremely high amounts of money belong to the same category. Furthermore, the fact that there are several focal points in the continuous variable suggested that it would be reasonable and representative to generate categories around these points. As a result, a more balanced variable with 6 ordered categories is generated - and used for further analysis - as follows:

Table 1: DEPENDENT VARIABLE: MONEY						
<i>label</i>	0	1	2	3	4	5
<i>categories</i>	0	1 – 15	16 – 30	50 – 70	90 – 100	> 149
<i>n</i>	115	39	46	28	17	24

In the statistical analysis of the next section, the dependent variable *money* is represented in three different ways, which correspond to three slightly different questions.

money(.): is a 6-category ordinal variable which includes all the observations exactly as described above. This variable attempts to shed light on the question: “which people - according to their physical traits and gender - request more money?”

money(1/0): is a dichotomous variable. The first category includes the 115 subjects who requested 0 euros, while the second category, which is an aggregation of categories 1-5 of the variable *money*, includes the 154 persons who requested a positive amount of money. In this case the question under examination is simply the following: “who actually requests money and who does not?”

money(>0): is a 5-category ordinal variable including only the 154 subjects who asked for a positive amount of money. The conditional question formed out of this approach is the following: “Given that people request a positive amount of money, who requests more?”

While the first two representations of the variable *money* may be obvious, the third one necessitates further explanation. We focus on this specific sub-sample mainly because we consider that all these people form a group of special interest. While there are several -

sometimes contradicting - reasons to explain why a person does not request any amount of money (interviewers' influence, subjects do not believe in experimental methods, they do not want to provide their address, etc.), we believe that the people who overpass these limits and finally request a positive amount of money belong to a more homogenous category with its own distinct argumentation for proceeding in such a way.

Regarding the independent variables enabled in the analysis, no complicated transformation takes place. These are:

obesity: an ordinal self-reported explanatory variable describing the level of subjects' obesity (from 1=very thin to 7=very obese).

beauty: an ordinal self-reported explanatory variable describing the level of subjects' beauty (from 1=very ugly to 7=very beautiful).

female: a dummy self-reported explanatory variable taking the value of 1 if the subject is female and 0 otherwise.

age: a continuous monitor-reported control variable describing subjects' age in years.

wage: a continuous monitor-reported¹⁹ control variable describing subjects' wage in euros.

ambition: an ordinal self-reported control variable describing the level of subjects' ambition (from 1=not ambitious at all to 7=very ambitious).

self-conf.: an ordinal self-reported control variable describing the level of subjects' self-confidence (from 1=not self-confident at all to 7=very self-confident).

Finally, it was also realized that the nature of the variable *obesity* was not as trivial as the variable *beauty*. While *beauty* could be characterized as a monotonic variable in terms of utility - the more beautiful someone feels the better he/she is - the case of *obesity* is not exactly the same. For instance, feeling that one is very thin does not necessarily imply that

¹⁹monitors' reports were preferred for shorting subjects' questionnaire and distracting subjects' attention

2.3. DATA CONSIDERATIONS

one is more attractive than someone who feels very obese. For this reason, two dummy variables were generated out of the variable *obesity* as follows:

dobese: a dummy variable taking the value of 1 if the subject reports level 5, 6 or 7 in the question on “obesity” and 0 otherwise,

dthin: a dummy variable taking the value of 1 if the subject reports level 1, 2 or 3 in the question on “obesity” and 0 otherwise.

As regards the descriptive statistics of the data, the 27 mediators collected data from 269 subjects. The subject pool was comprised of 55% females and 35% students. About 37% of the subjects did not work at all, 18% worked in a low-level job²⁰ and the remaining 45% had a medium or high-level job. Table 2 below shows the descriptive statistics of the variables used in our analysis.

Table 2: DESCRIPTIVE STATISTICS							
<i>Variable</i>	N	Mean	Median	Mode	Std. Dev	Min	Max
<i>obesity</i>	269	4.18	4	4	1.05	1	7
<i>beauty</i>	269	4.79	5	5	0.97	1	7
<i>female</i>	270	0.55	1	1	0.50	0	1
<i>age</i>	270	29.33	25	24	9.47	18	65
<i>wage</i>	171	1316.81	700	1500	848.44	100	7000
<i>ambition</i>	269	4.52	5	5	1.34	1	7
<i>self-conf</i>	269	4.49	5	5	1.48	1	7
<i>dobese</i>	269	0.33	0	0	0.47	0	1
<i>dthin</i>	269	0.20	0	0	0.40	0	1

From the above table we observe that:

Remark: The mean, the median and the mode of the variables beauty, ambition and self-confidence are much higher than expected. Subjects overestimated their characteristics, although it was emphasized that the median value is 4²¹. However, in the case of

²⁰Job characterization was due to researchers’ estimation.

²¹The Q2 questionnaires included the following hint: note that 4 means neither more (than the average) nor less.

obesity, the corresponding mean value approaches the expected one, while the mode and the median are exactly 4.

There are two suggested explanations for this. The first is simply that obesity is a more objective and easily observable characteristic. In other words, different levels of obesity are easily recognized by subjects, thus enabling them to describe themselves more accurately.

The second explanation, however, points in a contrary direction. First of all, what people consider to be normal - and they denote in our scale as 4 - is actually the obesity level of the majority of the population. In sharp contradiction, there is a vast amount of literature confirming that modern societies suffer from being overweight or obese. Therefore, it would be more reasonable for the true population mean of the variable *obesity* to lie around five. Finally, if this is the case, we conclude that, like the rest of the ordinal variables, non-obesity (using the same terms) is overestimated.

2.4. RESULTS

The aim of the first part of this section is to give an overview of the problem under examination. To do so, we examine the impact of each of the explanatory variables (beauty, obesity and gender) on our dependent variable by analyzing graphic and nonparametric tests. Finally, in the second part, we advance in our analysis by performing probit regression analysis which allows us to control for other factors that may impact our dependent variable.

2.4.1. PRELIMINARY RESULTS

In this subsection we try to shed light on any potential relation or trend between the dependent variable *money(.)* and the explanatory variables *beauty*, *obesity* and *gender*.

2.4. RESULTS

Obesity

The first figure shows the average amount of money requested by the members belonging to the seven different levels of the variable *obesity*. The size of the bubble is proportional to the number of people belonging to each level of obesity. Additionally, the number written in each bubble gives the precise number of subjects in each group.

Figure 2.2.: Average Money Requests by Obesity Level

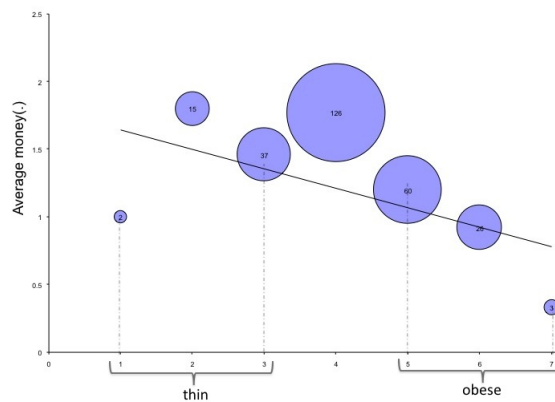

Note: The size of the bubbles (and the number shown) is proportional to the number of people belonging to each of the 7 obesity groups represented on the horizontal axis.

At first glance there does not appear to be a clear trend between the two variables under examination. However, when focusing more closely on the groups of people belonging to obesity levels 4-7, a clear negative trend can be seen, leading to the following observation:

Observation 1: The more obese a subject feels, the less money he/she requests on average.

Observation 1 is also supported by the nonparametric test (Cuzick and Mann-Whitney test). As is explained in detail in Appendix B, the different requests made between people at obesity level 4 and people at obesity level 5 and 6 are significant and negative.

On the other hand, there is no clear pattern for the average requests among the people who feel thin (level 1-3). Moreover, the combination of these two observations enforces our

argument that the variable *obesity* could actually be analyzed better if it is disentangled into two distinct variables, *dobese* and *dthin*, as described in the previous section. Finally, Figure 1 also includes the linear regression line, which reveals a smooth negative trend.

Beauty

Figure 2 provides exactly the same information as the first, but for the different levels of the variable *beauty*. In this case, the observation is even more clear and represents the whole sample:

Observation 2: The more beautiful a subject considers him/herself, the more money he/she requests on average.

Figure 2.3.: Average Money Requests by Beauty Level

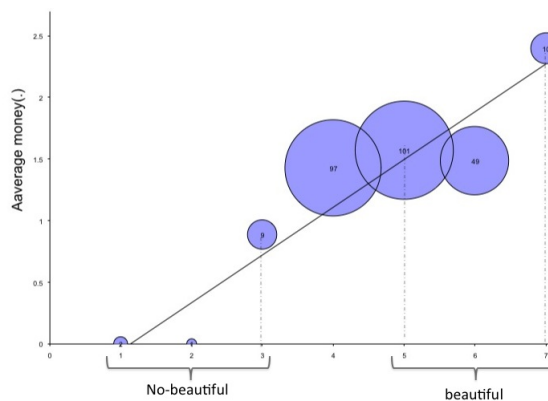

Note: The size of the bubbles (and the number shown) is proportional to the number of people belonging to each of the 7 beauty groups represented on the horizontal axis.

As is also illustrated from the linear regression line, there is a positive trend between average amount of money requested and different levels of beauty. Nevertheless, this claim is partially supported by nonparametric tests (for more details see Appendix B). The only

2.4. RESULTS

significant differences in *money(.)* requests are found between people at beauty level 7 and people at beauty level 1, 3 and 4.

Another secondary observation, which is also related to *Remark 1* of the previous section (page 11-12), is the fact that the mean value of *beauty* should lie very close to 5 as the majority of the observations and the median belong to category 5. Moreover, only 2 subjects and 1 subject report that they belong to beauty level 1 and 2, respectively, while there is quite a large number of observations for levels 6 and 7.

Gender

Finally, the following box-plot represents the *money(.)* requests by gender.

Figure 2.4.: Money Requests by Gender

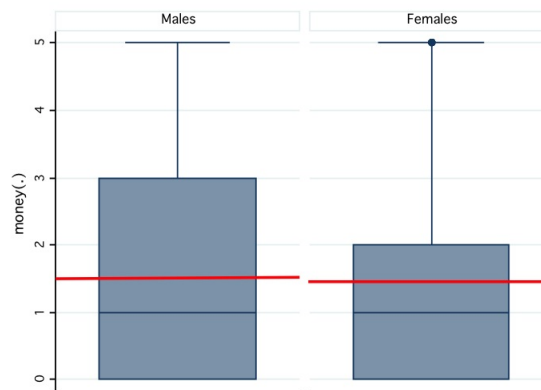

Note: The thick (red) lines indicate the means of each subsample

As we can see, the two subsamples have exactly the same median, while the males' mean (thick-red line) is slightly higher than the females' mean. The only notable difference occurs for the values of the upper quartiles where males are equal to 3 and females are equal to 2. Therefore, we can easily conclude:

Observation 3: There is no gender difference in money requests ²².

2.4.2. REGRESSION ANALYSIS

In this section, regression analysis is performed mainly for two reasons: a) we wish to control for the personality characteristics (ambition and self-confidence) and the socioeconomic variables (age, wage) that probably affect the dependent variable, and b) we want to control for the influence of interviewers on the subjects' answers.

This second reason is of great importance since we were unable to be present when the mediators were instructing the subjects and therefore could not monitor them. Although they were specifically instructed not to influence subjects' answers, we must still take into account that the subjects were either family members or colleagues²³. Consequently, during the following regression analysis we allow for intragroup correlation and relax the usual requirement that the observations be independent. That is, the observations are independent across groups (27 clusters for different interviewers), but not necessarily within groups. This kind of analysis affects the standard errors and variance-covariance matrix of the estimators, but not the estimated coefficients.

The following table reports the coefficients and the standard errors (in parenthesis) for two ordered probit regressions (columns 1(a) and 1(b)) on the dependent variable *money(.)*, two probit regressions (columns 2(a) and 2(b)) on the binary variable *money(1/0)* and finally two ordered probit regressions (columns 3(a) and 3(b)) on *money(> 0)*; all with the aforementioned cluster specification. The only difference between regressions of type (a) and (b) is that while *obesity* is used in the first ones as the main explanatory variable, the dummies *dobese* and *dthin* are engaged in the second ones in order to disentangle the effect. We control for the continuous variables *age*, *age*² and *wage* and for the ordinal variables *ambition* and *self-confidence* in all the regressions. No multicollinearity problem was observed in our

²² The same conclusion is fully confirmed by nonparametric tests (see Appendix B).

²³ A Kruskal-Wallis test on the variable *money(.)* for significant differences among groups of people dealing with different mediators confirms this claim ($Pr. > |z| = 0.0001$).

2.4. RESULTS

regression models ²⁴.

Table 3: PROBIT REGRESSIONS

<i>Variable</i>	<i>money(.)</i>		<i>money(1/0)</i>		<i>money(> 0)</i>	
	1(a)	1(b)	2(a)	2(b)	3(a)	3(b)
<i>obesity</i>	-0.109*		-0.054		-0.196**	
	(.063)		(.077)		(.090)	
<i>dobese</i>		-0.422***		-0.340**		-0.558***
		(.124)		(.150)		(.208)
<i>dthin</i>		-0.230		-0.347		-0.0500
		(.212)		(.253)		(.244)
<i>beauty</i>	.087	.073	.125*	.110	-.030	-.036
	(.077)	(.347)	(.077)	(.081)	(.090)	(.087)
<i>female</i>	-.003	.000	.044	.055	-.070	-.081
	(.167)	(.170)	(.200)	(.200)	(.219)	(.226)
<i>age</i>	-0.129**	-0.128**	-0.134**	-0.133**	-.092	-.095
	(.059)	(.057)	(.062)	(.060)	(.073)	(.071)
<i>age²</i>	.001*	.001*	.001*	.001*	.001	.001
	(.001)	(.0007)	(.001)	(.0007)	(.001)	(.001)
<i>wage</i>	-.000	-.000	-.0001*	-.0002*	.0004***	.0004***
	(.0001)	(.000)	(.0001)	(.0001)	(.0001)	(.0001)
<i>ambition</i>	.095	.098	.061	.060	.110*	.121**
	(.063)	(.063)	(.073)	(.073)	(.059)	(.062)
<i>self-conf</i>	.025	.027	.041	.042	.043	.047
	(.060)	(.060)	(.065)	(.065)	(.057)	(.058)
<i>constant</i>			2.042*	2.06*		
			(1.128)	(1.107)		
N	269	269	269	269	154	154
<i>Pr > chi2</i>	0.001	0.0000	0.0004	0.0001	0.0000	0.0000

Note: Standard errors (adjusted for 27 clusters in interviewers) of parameter estimates in parentheses. Significance level is marked with * for $p \leq 0.10$, ** for $p \leq 0.05$, and *** for $p \leq 0.01$.

In addition to the above illustrated models, the interval variable *money-interv.* and the continuous variable *money-cont.* are also analyzed in Appendix D using interval and tobit regression methods²⁵, respectively. Although one might consider that these two methods are

²⁴See Appendix C for Spearman's rank correlations coefficients among the regressors.

²⁵In both methods, the data for money requests equal to zero (115 observations) are left censored, while the data for money requests equal to or higher than 150 (24 observations) are right censored. These data correspond to category 0 and 5 of the dependent variable *money(.)* enabled in the ordered probit model.

more adequate for our data, the results are very similar to those obtained from the ordered probit model (1(a) and 1(b)). More specifically, the results are identical in terms of significance in the case of the three main variables under examination (*obesity*, *beauty*, *female*). However, for reasons of simplicity and comparison (with the binary-probit model) we only show the results of the ordered probit in the main body of this paper.

Following the same structure as in the previous subsection, we focus our analysis on the three main explanatory variables: *obesity*, *beauty* and *female*.

Obesity

As we can see from Table 3, regressions 1(a) and 3(a) confirm the negative association of the dependent variables (*money(.)* and *money(> 0)*) with obesity. In particular, *obesity* is associated with money at a 10% significance level in regression 1(a). However, when people requesting 0 euros are excluded from the sample in regression 3(a), the association is even stronger, reaching a 5% significance level. Nonetheless, while the sign of *obesity* remains negative in regression 2(a), it is not significant.

When disentangling *obesity* in regressions 1(b) and 3(b), the variable *dobese* is observed to be negatively associated at a 1% significant level in both models, while *dthin* is not (not even at 10% significance level). The same is true in regression 2(b), but *dobese* is associated with *money(1/0)* at a 5% level of significance. All these results suggest that the negative sign of 1(a), 2(a) and 3(a) is due to the fact that *obese* subjects (level 5, 6 and 7) request less money, but not because *thin* subjects request more money. Regarding obesity, there 3 main conclusions can be drawn from each of the dependent variables *money(.)*, *money(1/0)* and *money(> 0)*:

Result 1:

- a) (.):** “Obese” subjects request significantly less money than “non-obese” subjects.
- b) (1/0):** “Obese” subjects (significantly more times) do not request any money at all as compared to “non-obese” subjects.

c) (> 0): Among subjects who request a positive amount of money, “obese” subjects request significantly less than “non- obese” subjects.

Beauty

As regards the variable *beauty*, no significant association with the corresponding dependent variables of models 1(a), 3(a) and 1- 3(b) has been reported. The only exception is regression 2(a) in which *beauty* is positively and significantly associated with *money*(1/0) but only at the 10% significance level. Interestingly, *obesity* is not reported to be significant only in this specific model. Apparently, the significant dominance of *dobese* is recuperated in model 2(b), indicating once again that using the two dummies instead of *obesity* is probably the most reliable and consistent approach.

Despite our expectations as expressed in observation 2 of the previous subsection, the significant association of *beauty* with the dependent variable disappears as soon as the control variables *age*, *wage*, *ambition* and *self-confidence* are introduced in our regression. As shown in Appendix E, this is especially true for the variables *age* and *ambition* as their inclusion in the regression process immediately neutralizes the effect of *beauty* on *money*(.).

After controlling for all the aforementioned variables, the following overall conclusion dominates regardless of the regression model used:

Result 2: Subjects’ beauty has no significant effect on money requests (either on amount or frequency).

Gender

The same result is also true for the variable *female* as it is not significant in any of the aforementioned regressions (with or without controls). Nevertheless, a very strong observation emerged when performing the nonparametric tests (see Appendix B): the negative trend between money requests and *obesity* or *dobese* is confirmed only in the female subsample.

Additionally, this observation can be easily illustrated in the following figure where the

dark blue and the light red bubbles represent males' and females' money requests, respectively. It is clear that obese females (level 5, 6 and 7) request significantly less money than non-obese females (level 4). On the other hand, in the case of males, the negative trend is only true (but not significant) for the highest obesity levels (6 and 7), where there are only few observations.

Figure 2.5.: Average Money Requests by Obesity Level and Gender

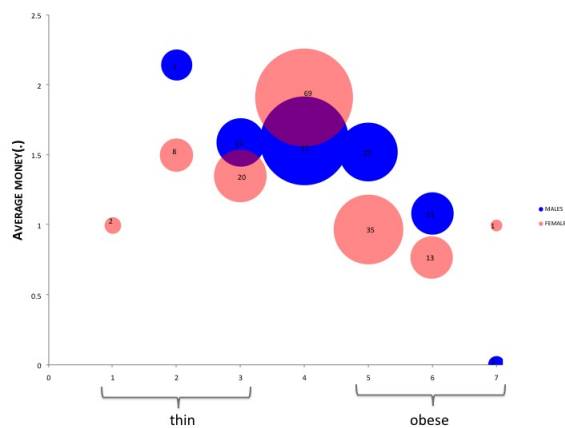

Note: The size of the bubbles is proportional to the number of people belonging in each one of the 7-obesity groups represented in the horizontal axe.

In order to demonstrate the combined effect of *female* and *obesity* on money requests, two interaction dummy terms have been incorporated into our regression model²⁶. These are:

fdobese: takes the value of 1 if the subject is both obese (level 5-7) and female and 0 otherwise.

mdobese: takes the value of 1 if the subject is both obese (level 5-7) and male and 0 otherwise.

²⁶For simplicity sake, only models (b) will be used as a reference.

2.4. RESULTS

In order to avoid problems of multicollinearity (and since *female* was not significant in any of the previous regressions), *female* and *dobese* are eventually replaced by the two new variables.

Table 4: ORDERED PROBIT REGRESSIONS
USING INTERACTION TERMS

<i>Variable</i>	<i>money(.)</i>	<i>money(1/0)</i>	<i>money(> 0)</i>
	1(b _i)	2(b _i)	3(b _i)
<i>fdobese</i>	-.53*** (.16)	-.42* (.21)	-.76** (.31)
<i>mdobese</i>	-.28 (.20)	-.23 (.19)	-.31 (.24)
<i>dthin</i>	-.23 (.21)	-.34 (.25)	-.04 (.24)
<i>beauty</i>	.07 (.07)	.11 (.08)	-.04 (.09)
<i>age</i>	-.12** (.05)	-.13** (.06)	-.10 (.07)
<i>age</i> ²	.001* (.000)	.001* (.000)	.001 (.001)
<i>wage</i>	-.000 (.001)	-.0002** (.0001)	.0004*** (.0001)
<i>ambition</i>	.09 (.06)	.06 (.07)	.12* (.06)
<i>self-conf</i>	.01 (.06)	.03 (.06)	.03 (.06)
<i>constant</i>		2.12** (1.07)	
N	269	269	154
<i>Pr > chi</i> ²	0.0000	0.0002	0.0001

NOTE: SE and significance level as previous table.

Comparing the results of the above table with the corresponding results of Table 3, we see that obesity is negatively and significantly associated with money requests only for females²⁷.

²⁷The same result is confirmed when the above regression analysis is repeated separately for the male and the female subsamples (see Appendix F for more details). We observe that the variable *obesity* in model 2(a) and *dobese* in models 1(b), 2(b), 3(b) are significant only for the female sample (with corresponding p-values: p(2a)=0.087, p(1b)=0.001, p(2b)=0.019 and p(3b)=0.014, respectively).

Due to the fact that males' obesity is also negatively (but not significantly) associated with the dependent variable, it is also expected that the significance of *fdobese* will be weakened. Interestingly, this result is only confirmed in regressions 2(b_i) and 3(b_i), but not in 1(b_i) where the 1% significant level is maintained. Finally, control variables generally have the same effect as in the regressions without interaction terms.

From the above analysis we can conclude:

Result 3: Although there is no significant gender effect on subjects' money requests (either on amount or frequency), there is evidence that the negative association between *money*, *money*(1/0), *money*(> 0) and *dobese* is mainly due to the participation of females in the sample.

Control variables

Finally, the following general remarks can be made regarding the control variables:

- 1) *Age* is negatively associated with the dependent variable in regressions 1(a&b) and 2(a&b), but not in regressions 3(a&b). A possible explanation is that the majority of people that requested 0 euros are older.
- 2) In regressions 3(a&b), *wage* turns positive and highly significant. This result indicates that high-wage people may request more money because they value their time more than other people.
- 3) The variable *ambition* was only found to be significant in regressions 3(a&b), supporting our claim that this particular sub-sample of 3(a&b) is comprised of a particular group of people with special characteristics such as ambition.
- 4) Despite our expectations the variable *self-confidence* is not appeared significant in any regression.

2.5. DISCUSSION

The basic finding of this study is that discriminated people, in particular obese, form lower initial requests when an opportunity of gaining a positive amount of money appears. Although, we are not suggesting this as the only explanation for the wage gap across discrimination, we consider that such a behavior grows the gap bigger. In fact, our explanation could be characterized as a “secondary” one (not because of its importance) as far as it is the second part of the “discrimination story”. Discriminated people, after having suffered discrimination in several social environments, including job, develop differential behavior by demanding less. As we have already argued, low initial requests could reason to low earnings due to anchoring effects (Tversky and Kahneman(59)).

Therefore, our experiment has been designed in order to capture exactly this secondary effect, after having assumed²⁸ that people, who feel different due to one or more of their physical traits, have suffered discrimination in the past. We claim that our basic experimental question corresponds to a question commonly asked by employers to job candidates: How much money would you like to receive for doing this particular job?

Moreover, the whole design can be characterized as a truthful approximation of a salary negotiation for a job between two participants: 1) The human resource manager representing an institution, who, in experimental terms, corresponds to the mediator representing the University of Granada 2) The job candidate, who corresponds to our subject for the task of filling out the questionnaire. Additionally, we propose that questionnaire’s filling corresponds to a real task accomplishment in the job. Therefore, subject’s question about *how much money he/she would like to request as a compensation for the effort he/she made to complete this particular questionnaire and for the information they provided us* corresponds to job candidate’s question about the money he/she would demand for the effort he/she will make for accomplishing the specific task of the job and for the outcome provided.

²⁸We have implicitly assumed that people who feel different (inferior) due to some physical characteristic of theirs, have suffered discrimination in the past. Directly asking them for past discrimination experiences would compromise our dependent variable, i.e. the amount requested since subjects could unravel the purpose of the research, falling pray to demand effects

The main result of our study is that relatively obese people demand significantly less money than non-obese. Although, two main explanations (self-fulfilling prophecy or low self-esteem) have been suggested in the introduction, not enough evidence was provided for any of them. It can be also argued that the channel obesity/low self-esteem/low earnings has not been properly functioned as the the variable *self-confidence* has been reported neither significant in any of the regressions nor correlated with obesity (see Appendix C). The main explanation and one of the limitations of this study is that the self-reported self-confidence was not a good measure of self-esteem. Contrary to beauty and obesity which are two obvious physical aspects and easily admitted by subjects, self-confidence (and probably ambition) is hardly realized by subjects themselves and consequently miss-reported.

Given that obese people developed a special behavior in our dataset, we focus more closely on them. In particular, we want to find out whether their self-reports on obesity are also confirmed by their monitors' reports. The following graph (Figure 5) shows, for each of the main obesity categories ²⁹, the percentage of people who underestimate (self-report < monitor's report), accurately-estimate (self-report = monitor's report) or overestimate (self-report > monitor's report) their own obesity level compared to the monitor's evaluation.

It is quite interesting to note that the percentage of people (62%) who overestimate their obesity level in the "obese" category is much higher than the percentage of "thin" subjects (42%) or the percentage of subjects who categorize themselves as "normal" (44%). A Mann-Whitney test³⁰ confirms that both percentage differences are statistically significant with $Pr > |z| = 0.028$ and $Pr > |z| = 0.010$, respectively.

Taking into account the well documented in social psychology studies (Miller & Downey (45)) negative relation between perceived weigh and self-esteem, it seems that people who *overestimate* their own obesity level probably have lower self-esteem³¹ even when compared

²⁹In order to facilitate this analysis we aggregate obesity levels 1, 2 and 3 into the "thin" category and levels 5, 6 and 7 into the "obese" category.

³⁰In order to perform the test, the binary variable *overestimation* (=1 if sr > mr, =0 otherwise) is used.

³¹It is a theoretical assumption. Even this self-overestimated obese sub-sample has not reported a significant lower self-confidence level.

2.5. DISCUSSION

Figure 2.6.: Subjects' reports compared to Monitors' reports

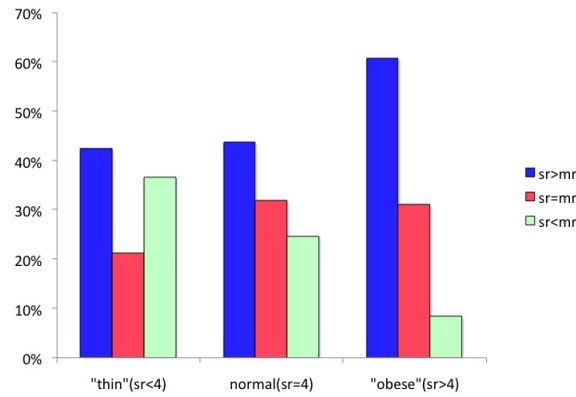

Note: *sr* stands for self-reports while *mr* stands for monitors' reports on obesity.

to others (both underestimating and accurate-estimating) obese people. Therefore, according to our experimental setting, it is expected that this particular type of obese person would request a lower amount of money. Focusing on the far right section of the following graph (Figure 6) where the average money requests by different types (according to “misestimation”) of obese people is described, it is confirmed that overestimating-obesity obese people ($sr > mr$) request the least money compared to the other obese types.

Figure 2.7.: Money Requests by Obesity Misestimation

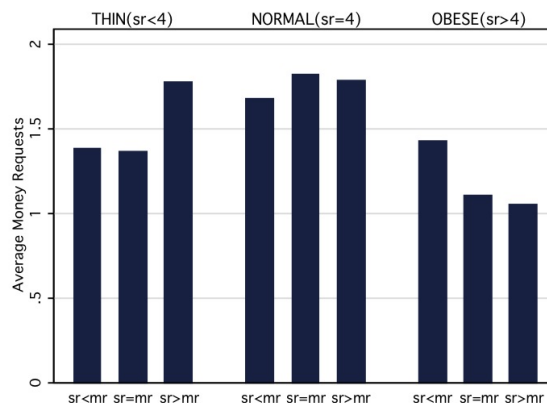

Note: *sr* stands for self-reports while *mr* stands for monitors' reports on obesity

Nevertheless, the negative trend illustrated above was not shown to be significant neither when using a Mann-Whitney test, nor as an explanatory variable³² in the regression analysis.

Concerning the variable *beauty*, results did not meet our initial expectations. Unlike the obese people, the “non-beautiful” people did not request, on average, a significantly different amount of money than beautiful or normal people. In our opinion, this result can be explained by how people perceive beauty. As it has been shown in Figure 2, people tend to overestimate their beauty level, since only 12 out of 269 subjects (4.5%) self-report that they belong to beauty level 1,2 or 3, while the mean of our sample is almost 5. Moreover, beauty, compared to obesity, is a less-observable trait. Therefore, it is easier for a person not to admit or even hide that he/she is “ugly”, while it is almost impossible to do the same when one is overweight. Although the distribution of this variable was not the expected one and no significant impact on the dependent variable was revealed, we still consider that it correctly illustrated how people perceive themselves in terms of beauty.

Regarding the absence of a gender effect, a possible explanation is that females’ decisions are more context dependent (see Croson & Gneezy(29)). Our experimental job negotiation conditions might not have been representative enough for women to react in the expected way. Another argument, coming from the negotiation literature (Small et al(57)), is that gender differences in initial requests are dramatically reduced when situations are framed as opportunities for asking and not as opportunities to negotiate. Nevertheless, as shown in the last part of the results, obesity appears to be significant only in females’ requests, while obesity was not significant at all in the male sample. An explanation for this result can be found in the studies by Hatfield & Sprecher (38) and Zebrowitz(65) who claim that human culture values attractiveness more in females than in males.

The overall conclusion of this study is that relatively obese people demand less or nothing when faced with the opportunity of earning a positive amount of money, a result that could partially explain the well-established wage gap. Such a generalization of course meets sev-

³²To this aim, a dummy variable indicating obesity overestimation was introduced in the basic regression models.

2.5. DISCUSSION

eral limitations. As with the vast body of experimental studies, standard criticisms of the representativeness of our subject pool apply. Furthermore, interviewers' influence on subjects' answers could only be controlled statistically. Another important caveat is that we model an one-shot interaction between subjects and monitors while in real life the salary negotiation process may last for longer, leaving time to both employers and candidates to readjust their strategies. Finally, real job seekers are well-prepared for their "life-time" negotiation, while our not-so-prepared fictional candidates have to cope suddenly with an unplanned negotiation. For this reason, money requests of our opportunistic sample might correspond better to an occasional real job negotiation where the opportunity cost is not as high as in a permanent job.

If one is willing to extrapolate from our experiment to the labor market more generally, we can draw a very important policy implication for reducing the wage gap: Information campaigns and programs against discrimination in the working environment should also target in encouraging of actual or potential discriminated persons.

ACCOUNTING FOR REAL WEALTH IN HETEROGENEOUS-ENDOWMENT PUBLIC GOOD GAMES

Abstract

Wealth¹ heterogeneity influences people's behavior in several socioeconomic environments, especially when groups consisting of "*unequal*" members have to take a collective action which affects all members *equally* or proportionally. After eliciting real out-of-lab wealth, we form 4-player groups playing an one-shot public good game with heterogeneous laboratory endowments. Endowing subjects according or against their real wealth gives rise to a series of interesting results. Endowment heterogeneity, lack of real relative wealth information and being "rich" both inside and outside the lab raise contributions. Finally, when eliciting subjects' beliefs, we find out that only relatively "poor" subjects expect others to contribute more than what they actually are prepared to do themselves.

3.1. INTRODUCTION

Wealth heterogeneity is present in several real-life contexts in which people voluntarily contribute to a public good. However, the effect of wealth disparities on individual contributions

¹This chapter is part of a joint work with Nikolaos Georgantzis from the Universidad de Granada.

to a public good is not fully understood. Similarly, the role of public information regarding these disparities is also far from clear. For example, there is a general tendency to introduce transparency on people's true income as a means of reducing tax evasion, while, as we show in this paper, the effectiveness of this policy may not be as straightforward as it sounds.

So far, experimentalists wishing to study the effects of wealth inequality on public good contributions use endowment heterogeneity as the laboratory analogous of real-life wealth differences (see Buckley and Croson, 2006(69), Cherry et al., 2005(74), Anderson et al., 2008(66), Chan et al., 1996(72), 1999(73), Fisher et al., 1994(76). Also see Zelmer, 2003(85) for a metanalysis and Ledyard, 1995(77) for a detailed review of Public Good Games.). To our knowledge, there are no laboratory Public Good experiments investigating the interaction between real and experimental income heterogeneity.

Even in Cardenas (2003) (71) and Burns & Visser (2008) (70)) where Public Good *field* experiments with real wealth and experimental income are conducted the interaction between these two factors was out of the authors' research interest. Actually, in neither experiment was subjects' real wealth distribution revealed among members of the same group. Therefore, the interplay between laboratory endowment and real income heterogeneity has not been studied so far neither in the laboratory nor in the field. However, if we admit that overall wealth affects contribution levels, it is reasonable to ask how endowment heterogeneity induced in the lab interacts with wealth heterogeneity outside the lab in order to determine a subject's contribution.

In this paper, we address this issue. Our design is based on a pre-play elicitation of our subjects' disposable income which is then used to form specific heterogeneous four-player combinations of wealth and endowment heterogeneity. We also consider the alternative of random endowment heterogeneity which corresponds to the usual practice of not controlling for real-life income when inducing endowment heterogeneity in the lab. Furthermore, we study the effect of knowing one's relative position in the group in terms of real wealth, in isolation from the income and endowment heterogeneity effects themselves. Finally, we look

at the relation between subjects' beliefs on others' contributions (with the same or different endowment and wealth level) and the actual contribution of each subject.

Buckley and Croson's (2006) (69) experiment can be considered as the most relevant to our study. They conduct a repeated Public Good game with heterogeneous endowment, where subjects are informed about others' wealth before each period starts. In contrast with our design where real out-of-lab wealth is elicited and announced to all members of the same group, they use experimental "wealth" which corresponds to the cumulative profits² from earlier periods.

In our study, the elicitation of real wealth was one of the most challenging tasks. This is mainly due to the fact that, generally speaking, information on real income or wealth should be used jointly with an individual's spending needs and saving habits. We tackle this issue by using a rather homogeneous subject pool of economics students at the University of Crete with little if any saving behavior. Our strategy was aimed at identifying both personal and indirect sources of the student's disposable income, like parents' wealth and that of other family members supporting the student with monetary gifts in a relatively regular basis. The final index of a subject's wealth is a composite measure of parents' salaries and monthly allowances coming from other family assets.

Our main findings are the following. Subjects contribute a lower percentage of their laboratory income if they receive the high endowment. Furthermore, contrary to previous results that report negative (i.e. Anderson et al., 2008(66), Cherry et al. 2005(74), Bagnoli and McKee (1991) (67)) or no effect (Marwell and Ames 1979(78),1980(79), Sadrieh and Verbon, 2004(83)) of inequality, we find that group heterogeneity increases the level of voluntary contributions. On the contrary, the availability of information on real wealth heterogeneity reduces contribution levels and the relative size of contributions as a percentage of laboratory endowments. Furthermore, out-of-lab wealth may have a positive effect on contributions, as long as a rich subject receives the high endowment and a poor subject the low one. People

²Actually, before each period the following information is revealed a)their earnings from the last round, b)their earnings to date (wealth) c) the average wealth of the group to date.

who are “rich” both in and out of the lab contribute a significantly higher percentage of their endowment compared to people who are “poor” in and out of lab. Finally, looking at beliefs, poor subjects tend to adopt the most irresponsible and selfish attitude of someone who expects others to contribute more than what he actually is prepared to do himself.

The paper proceeds as follows. In Section 2 we give a brief overview of experimental papers that study endowment heterogeneity in Public Good settings. In Section 3 we discuss our experimental design and procedures. Section 4 presents the experimental results of contributions and beliefs both in absolute and relative terms. Finally, Section 5 concludes.

3.2. LITERATURE REVIEW

The literature in heterogeneous endowment Public Good games is extensive and reports a variety of results. Nevertheless, to the best of our knowledge, there is no experiment studying the interplay between real and experimental income. As mentioned before, the most relative laboratory experiment to our study is the one by Buckley and Croson (2006) (69). Disregarding the experimental origin of “wealth”, the main result of that study is in contrast with our findings. While they report that relative contributions by individuals with low wealth are significantly higher than those by individuals with high wealth³, we find that the relative contributions of “rich” people are the highest, no matter their experimental endowment. In the same study, it is also rejected the hypothesis that individuals with a high endowment will contribute a larger amount and percentage of their per-period income to the public good than subjects with a low endowment.

Along the same line, in Sadrieh et al. (2004) (83), endowments vary in a dynamic setting, where each round earnings are added to the available endowment in the following round. In this design, which did not include a baseline treatment of equality, they found that contribution levels did not vary with the degree of inequality.

In another study by Anderson et al. (2008) (66) it is tested whether inequality (in ini-

³In absolute terms the corresponded contributions are not different.

tial endowments) within a group reduces individual contributions. They find that only when made salient through public information about each individual's standing within the group, inequality reduces contributions to the Public Good for all group members. Our analysis approaches this result in the sense that when we informed subjects about real wealth inequality their contributions were also decreased. However, this result was independent of endowment heterogeneity.

Furthermore, Cherry et al. (2005) (74) represents repeated linear⁴ Public Good game where experimental income heterogeneity was introduced by giving to subjects different (10,20,30,40€) initial endowments. In contrast to our results, they suggest that contribution levels were significantly lower when groups had heterogeneous rather than homogeneous endowments. However, as it is also proved in our analysis, contributions were not affected by the origin⁵ of endowment. Once more, real wealth and its interaction with experimental endowments was not taken into account.

In Zelmer (2003) (85), 27 studies (representing a total of 711 groups of participants) are pooled and analysed. Among other results, he finds that *heterogeneous endowments to subjects*, experienced participants, and soliciting subjects' beliefs regarding other participants' behavior prior to the start of the session/period had a negative and significant effect.

Giving a glance to the studies before 1995, the seminal paper by Ledyard (1995) (77) gives a detailed review of several studies examining inequality (among endowments or the value of the public good) in linear public goods setting. The results are contradictory. For example, Bagnoli and McKee (1991) (67) find that inequality reduces contributions to the group account, while Marwell and Ames (1979(78),1980(79)) report that inequality has no effect on contributions. In another linear public goods game, Brookshire et al. (1993) (68) interact inequality in the value of the public good with information; in some cases, group

⁴The income heterogeneity is also investigated in no-linear Public Good games (see Chan et al. 1996(72), 1999(73), Rapoport and Suleiman(1993) (82)). Even in these cases, results regarding the impact of endowment heterogeneity are mixed or even contradicting while real wealth and its effect on contributions is out of authors' investigation interest.

⁵Of course a different endowment origin is tested in their design (windfall versus by effort) as compared to ours (windfall versus by design).

account contributions are unaffected by inequality, while in others, contributions increase.

Finally, as mentioned in the introduction, there are two field experiments which take into account real out-of-lab wealth. The first one by Cardenas (2003) (71), explores how wealth and inequality can affect self-governed solutions to commons dilemmas by constraining group cooperation. In contradiction with our results, participants' wealth and inequality reduced cooperation when groups were allowed to have face-to-face communication between rounds.

The second field Public Good experiment by Burns and Viser (2008) (70) shows that contributions to the public good are increasing in income levels, and that income heterogeneity is associated with greater contributions towards the public good, especially by those at the lower end of the income distribution. While both experiments study the effect of real wealth on contributions, neither one makes public the relative real wealth of participants in the same group.

As it will be described in detail in the next session, the participants of our experiment were informed explicitly on their own and other participants relative real wealth position in the sample.

3.3. EXPERIMENTAL DESIGN AND METHOD

The experiment was conducted in three separate stages: elicitation of real wealth, participation in a Public Good game and belief elicitation. In the first stage, subjects, who were recruited among economics students at the University of Crete (Campus at Gallos, Rethymon), were asked to answer a questionnaire eliciting their real wealth. To this aim, we had to take into account that all our subjects were students whose disposable income, in most of the cases, depended on family wealth. It is also true that it is rather difficult for them to know exactly their families' wealth.

For this reason, we constructed a questionnaire which followed a *maieutic* method, in the sense that it made students think about their families' economic situation before making

any family income estimation. In particular, they were asked to describe family assets (i.e. number of cars, houses and field properties in m^2 etc.) while, additional questions were asked, regarding their own spending habits. At the end of the questionnaire, after assuring them for their answers' anonymity, they are asked to reveal their parents' monthly salary and to make an estimation of other family assets returns. Finally, they were asked to make an estimation of their own relative wealth position⁶ compared to other participants' wealth.

Following this exercise, subjects were classified into two different wealth groups according to their answers. Subjects whose reported wealth was higher than the median⁷ were characterized as relatively rich (henceforth R), while subjects whose wealth was lower than the median were labeled as the relatively poor (henceforth P) of their session. From the 96 subjects, 39 subjects had placed themselves in the same category as we also did, 50 had reported that they were neither R nor P and only 5 had placed themselves in a different to our categorization group. Finally, there were two subjects who did not want to comment on their families' relative income position.

The second stage of the experiment was a standard paper-and-pencil linear public good game (see Ledyard (1995) (77)). Each one of four individuals in a randomly and anonymously formed group decides how to spend his/her initial endowment splitting it between a private account and a public good. All money placed in one's private account were directly added to the subject's earnings, while money placed in the public account was multiplied by 2 and divided equally among the group members. While the social optimum is for each subject to contribute his/her entire endowment to the public account, the Nash equilibrium is for each person to allocate his entire endowment into his private account. There are three baseline (type B) treatments taking place in our setting:

B1020: Heterogeneous groups with two subjects randomly endowed with 10€ and another two with 20€.

B10: Homogeneous groups with all subjects endowed with 10€.

⁶They had to choose among 5 answers: very poor, poor, neither poor nor rich, rich, very rich.

⁷Family wealth was calculated by adding parents' monthly salary to monthly income from other assets.

B20: Homogeneous groups with all subjects endowed with 20€.

In treatment R, 4-member groups of 2 *Rs* and 2 *Ps* were formed and randomly endowed with 10€ and 20€. Each member of the group was informed about the random endowment process and its final own and other members' real relative wealth. As a result of this randomization three different types of group are formed ex-post:

RP10: Two *Ps* were randomly endowed with 10€ and two *Rs* with 20€.

RP20: Two *Ps* were randomly endowed with 20€ and two *Rs* with 10€.

RP1020: One *P* was randomly endowed with 20€ while the other with 10€ and one *R* was also endowed with 20€ while the other with 10€.

Apart from the above “windfall” endowing mechanism, we are also interested in testing the effect of other endowing mechanisms. As a result, two more treatments where heterogeneous endowments were allocated to either *Ps* or *Rs* not randomly but by design⁸ were introduced:

DP10: Two *Ps* were by design endowed with 10€ and two *Rs* with 20€.

DP20: Two *Ps* are by design endowed with 20€ and two *Rs* with 10€.

In our analysis we will also refer to *RP10* and *DP10* as *unfair allocations* and to *RP20* and *DP20* as *fair allocations*.

Finally, in the third stage of our experiment, subjects are asked to reveal their beliefs on others' contributions. Depending on the treatment's degree of heterogeneity subjects were asked to reveal their beliefs on other subjects' of the same or of other type contributions. In the end of this stage, subjects were also asked about their beliefs on what other subjects “ought” to contribute.

⁸For instance in *DP10*, *Ps* were instructed that they received 10€ *because* they were relatively poor while *Rs* receive 20€ *because* they were relatively rich. The reverse reasoning was followed in *DP20*.

3.4. RESULTS

Results are divided in to two basic subsections: contributions and beliefs on others' contributions. In each subsection, both graphical and regression analyses are performed.

3.4.1. RELATIVE AND ABSOLUTE CONTRIBUTIONS

SUMMARY STATISTICS

The public good game was played only once to remove any inter-temporal belief formation and strategic choices or signaling. While 132 students participated in the first stage of the experiment, only 96 participated in the three Public Good sessions. Sessions lasted about 1 hour, including reading the instructions while the average compensation per subject was about 25€, including a 5€ participation fee.

Figure 3.1.: Absolute Contributions

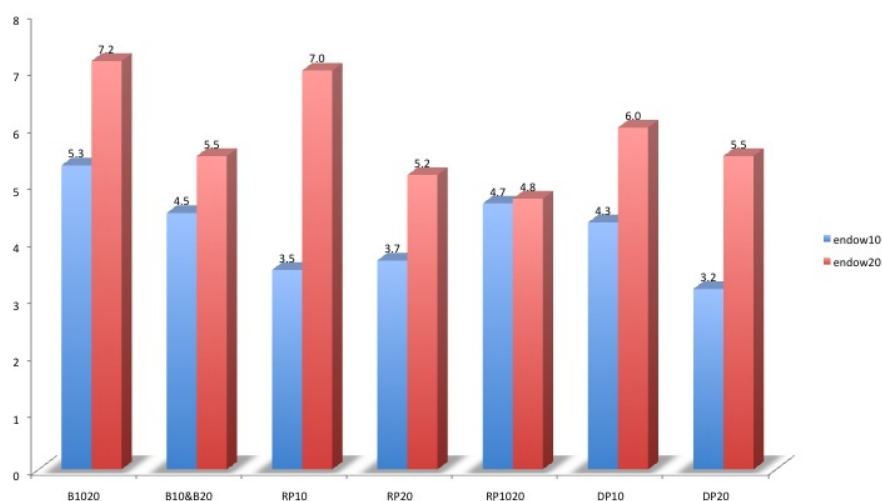

In figures 1 and 2, relative and absolute contributions by treatment and endowment category are illustrated⁹. Note that that the level of endowment (10€ or 20€), when it is related to a specific treatment, reveals the wealth level of the participant. For instance, the *endow10*

⁹The corresponded table of actual values (with standard errors) and Box Plots are included in Appendix 1.

3.4. RESULTS

person in DP20 treatment is also a *Rich* person. The only exception (for facilitating illustration) is RP1020 treatment in which *endow10* (or *endow20*) can be either *Rich* or *Poor*.

Using a Mann-Whitney test we find significant treatment effects in both absolute and relative contributions. Checking for endowment effects within treatments we find that in the DP20 treatment, P20 subjects contribute in absolute terms significantly ($p = .094$) more than R10 subjects and in the RP1020 treatment, subjects (both R and P) endowed with 10€ contribute a significantly ($p = .059$) higher percentage of their endowment compared to the relative contributions of the high endowed participants.

Figure 3.2.: Relative Contributions

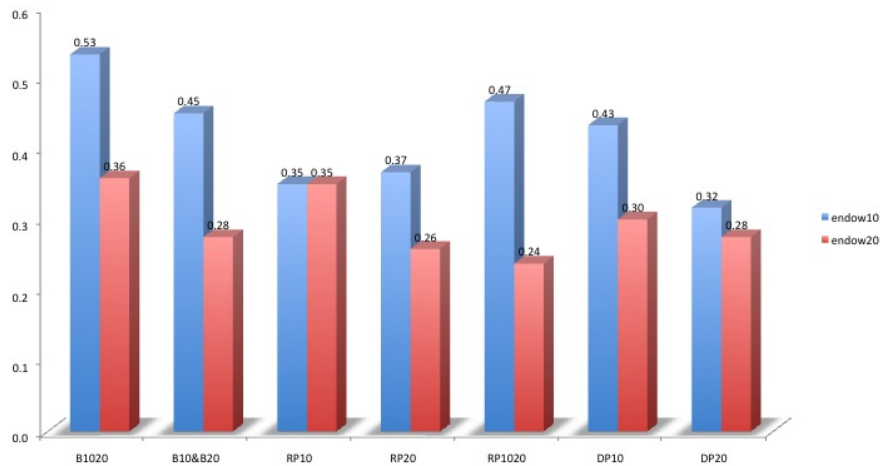

Aggregating data from all treatments, we find that subjects endowed with 20€ contribute significantly less ($p = .003$) in relative terms and significantly more ($p = .045$) in absolute terms compared to subjects endowed with 10€. Moreover, a between treatments comparison reveals that the overall contributions from all participants in the base treatment B1020 are significantly higher both in absolute ($p = .069$) and relative ($p = .081$) terms compared to the overall contributions when pooling data from RP20 and DP20¹⁰. Therefore, such a

¹⁰Pooling data from groups RP20 and DP20 is not meaningless since both groups have the same characteristics regarding endowment and wealth while a Mann Whitney test has confirmed that there is no significant difference between the two treatments. The same argument is even more supported when the variable *design* is proven not significant in any of the regressions performed in the next section.

comparison shows that: *fair allocations, no matter their origin (random or by design), have a significant negative effect on both absolute and relative contributions.*

When comparing absolute contributions in the baseline treatment B1020 with contributions in treatments R (RP10, RP20 and RP1020), we find that the latter's group contributions are significantly ($p = .087$) lower. Taking into account that the only condition changing between these two treatments is the fact that, in the latter, subjects are additionally informed about their relative real wealth, we can conclude that: *Informing people about their own and others' relative real wealth has a negative effect on absolute contributions.*

REGRESSION ANALYSIS

In the following paragraphs regression analysis is discussed. A Tobit model has been selected as the most adequate, censoring data both from the left and the right. A cluster specification¹¹ on the seven different treatments is also used¹². The dependent variable in all regressions is either absolute contribution (henceforth $|c|$) or relative contribution (henceforth $\%c$). The following dummy variables are introduced as independent regressors:

info : indicating whether subjects in the group are informed about their own and other's relative real wealth (R+D treatments).

design : indicating whether subjects receives their endowment by design rather than randomly (D).

hetero2 : indicating groups with 2 different types of subjects (B1020+RP10+RP20+ D).

hetero4 : indicating groups with 4 different types of subjects (R1020).

endow20 : indicating whether subjects have been endowed with 20€.

¹¹Tobit regressions without the cluster specification are also available in the Appendix 2. As expected, results keep in the same line, although weakened.

¹² Cluster specifies that the standard errors allow for intra-group correlation, relaxing the usual requirement that the observations be independent. That is, the observations are independent across groups (clusters) but not necessarily within groups.

rich : indicating whether the subject is relatively rich outside the lab.

rich20 : the interaction of the *endow20* and *rich* variables.

Finally, we define two control dummy variables capturing subject's gender and whether a subject has received a game theoretic class in the past and a continuous control variable with the subject's year of studies.¹³

Table 1 reports the coefficients and the standard errors (in parenthesis) for four independent tobit regressions. In the first two (columns 1(a) and 1(b)) the dependent variable is $|c|$ while in the following two (columns 2(a) and 2(b)) the dependent variable is $\%c$, all with the aforementioned cluster specification. The regressions of type (b) differ to ones of type (a) in the interaction term *rico20*. No multicollinearity problem was reported in any of our regression models.

¹³Although these variables are introduced as controls in all regressions, their coefficient estimates are not reported because they are not significant.

CHAPTER 3. ACCOUNTING FOR REAL WEALTH IN
HETEROGENEOUS-ENDOWMENT PUBLIC GOOD GAMES

Table 1: TOBIT REGRESSIONS ON CONTRIBUTIONS

<i>Variable</i>	<i> contributions </i>		<i>%contributions</i>	
	1(a)	1(b)	2(a)	2(b)
<i>info</i>	-3.75*** (.61)	-3.93*** (.90)	-.22*** (.03)	-.23*** (.04)
<i>design</i>	.11 (.90)	-.64 (.46)	-.01 (.05)	-.02 (.03)
<i>hetero2</i>	3.30*** (.46)	3.94*** (.45)	.18*** (.03)	.21*** (.02)
<i>hetero4</i>	4.41*** (.79)	5.09*** (1.05)	.26*** (.05)	.29*** (.05)
<i>endow20</i>	.63 (.65)	-1.49 (1.02)	-.15*** (.04)	-.23*** (.05)
<i>rich</i>	-.44 (.59)	-2.63*** (.91)	-.01 (.03)	-.09* (.05)
<i>rich20</i>		4.06*** (1.36)		.16** (.08)
<i>constant</i>	5.13 (1.68)	6.35 (1.58)	.46*** (.08)	.50*** (.07)
N	94	94	94	94
cens. obs.	10/4	10/4	10/4	10/4

* significant at 10%; ** significant at 5%; *** significant at 1%

Below, we summarize the main results emerging from the regressions. It is more than obvious (at 1% significance level) in all regressions the negative effect of information and the positive of heterogeneity. Therefore, the first two results are the following:

Result 1 : Informing people about their relative real wealth has a negative effect both on absolute and relative contributions.

Result 2 : Endowment (lab) inequality (no matter the degree) increases both absolute and relative contributions.

It is also clear from all regressions that design has no significant effect on the depended variables.

Result 3 : Endowment origin (randomly or by design) has no effect on contributions.

3.4. RESULTS

The negative sign of variable *endow20* in regression (2a) (but not in (1a)), means that *all* highly endowed people contribute less in relative terms:

Result 4 : Laboratory endowments affect relative contributions only. Subjects contribute a lower percentage of their laboratory income if they receive the high endowment.

When the interaction term *rich20* is incorporated in regression (2b), *endow20* represents only the *poor20* subjects. Therefore, the following result clarifies:

Result 5 : The negative endowment effect on relative contributions is due to “poor” subjects endowed with 20€. *rich20* subjects contribute a significantly higher percentage of their endowment compared to *poor10* people.

Finally, focusing on absolute contributions, we see that *rich* becomes significant only after the interaction term is added:

Result 6 : Out of lab wealth may have a positive effect on absolute contributions, as long as a rich subject receives the high endowment and/or a poor subject the low one. *rich20* contribute significantly more and *rich10* significantly less than *poor* subjects¹⁴. Therefore, out of lab wealth explains contributions as long as laboratory endowments reproduce subjects’ income positions in the real world.

3.4.2. BELIEFS ON CONTRIBUTIONS

In this section, we shed light to subjects’ beliefs about other subjects’ performance. In all treatments, subjects are asked about their beliefs on the contributions of other subjects in the same group. In B10 and B20 homogeneous treatments, subjects, who are of the same type regarding their initial endowment, reveal their beliefs on the contributions of same type (henceforth b_s) other subjects.

¹⁴Although in this regression the control group is *poor10*, when we use as a regressor all *poor* people the result still holds.

However, in treatments B1020, RP10, RP20, DP10 and DP20, we always have two different types of subjects (regarding their endowment and wealth level) within the same group. Therefore, subjects are asked on their beliefs regarding others' contributions of the same (b_s) or of the other (b_o) type. For instance, in DP10 treatment which consists of two P10 and two R20 subjects, P10 subjects are asked to make two separate estimations on the absolute contributions of the others. The first one, b_s , corresponds to the contribution of the remaining one P10 subject of the group, while the second one, b_o , corresponds to the average contribution of the two R20 subjects of the same group.

Finally, in treatment RP1020, all four subjects of the same group are of different type (P10, R10, P20, R20) which means that subjects are asked only for b_o .

Because in all treatments, b_s and b_o correspond always to different initial endowment levels, the relative values of the above variables are used, so that meaningful comparisons can be made. Figure 3 illustrates the mean belief on contributions of same and other type per treatment and endowment category. Once more, the level of endowment (10€ or 20€), when it is related to a specific treatment (except in the case of RP1020), reveals the wealth level of the participant. Thus, the grey bar in DP10 treatment with endowment 10, indicates the belief of a *Poor* subject endowed with 10€ on the contribution of the other *Poor10* of the group. The yellow bar, corresponded to the same person shows the the belief of the same *Poor10* on the average contribution of the remaining two *Rich20* subjects of the group.

A first observation is that in almost all treatments b_o is higher than b_s , indicating that no matter the endowment level or the specific treatment, subjects tend to believe that subjects of the other type contribute more. When pooling data from all treatments and performing a Wilcoxon¹⁵ test, this claim is supported in $p < 0.01$ significant level.

Strangerly, there are two exceptions bearing however very similar characteristics. *Rich* subjects from RP20 and DP20 are the only ones endowed (either randomly or by design) with 10€ who believe that subjects of their own type contribute more than other type. Although

¹⁵It is about the matched-pairs signed-ranks test (Wilcoxon 1945) testing the equality of matched pairs (b_s and b_o) of observations.

Figure 3.3.: Mean of Beliefs of Same and Other type Contributions

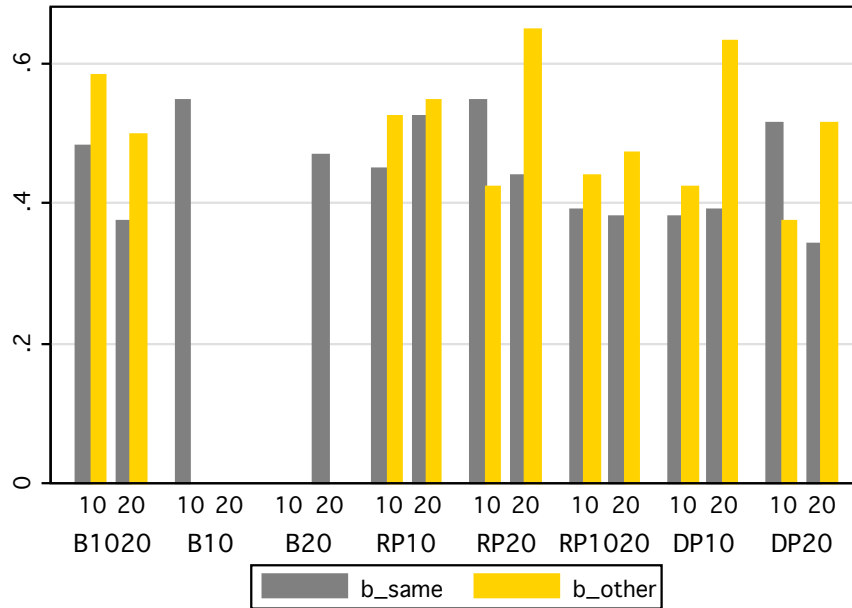

they are low-endowment subjects, they believe that real wealth may be more important than initial endowment and they expect that b_s are higher than b_o , no matter if “others” are highly endowed. However, such a claim is not supported by Wilcoxon test.

We have also performed Wilcoxon tests for different subsamples of the pooled data. We found that highly endowed (but not low-endowed) and “*Poor*” (but not “*Rich*”) subjects believe that subjects of the same type contribute significantly ($p < 0.01$) less than the ones of the other type.¹⁶ In the case of highly endowed subjects, the result seems to be self-explained by the effect of the variable itself (i.e. 50% of 20€ is double than 50% of 10€, so highly endowed expect a higher percentage offered by the low-endowed subjects). Along the same argument, when performing a Wilcoxon test between the absolute values of b_s and b_o of highly endowed subsample, the former now turns significantly higher ($p < 0.01$) than the latter. Moreover, in the low-endowed subsample, absolute b_s is significantly ($p < 0.01$) lower than b_o .

¹⁶ The differences between beliefs on same and other type relative contributions for the subcategories of *Rich20*, *Rich10*, *Poor20*, *Poor10* can also be seen in Figure 12 of Appendix 3. In the same figure are also illustrated the beliefs on what other subjects ought to contribute.

However, the explanation does not seem that simple in “*Poor*’s” subsample. While “*Poor*” subjects believe (both in absolute¹⁷ and relative terms) that b_s is lower than b_o the contrary relation is not confirmed by the “*Rich*” subsample. “*Rich*” subjects believe that b_s is not different to b_o . These differences in beliefs may be the explanation of the lower actual contributions of “*Poor*” subjects demonstrated in the previous section. In accordance with theories of selective perception/interpretation (see Pinkley et al., 1995(81) on information processing errors, Dana et al., 2007(75) about moral wiggling room and Stewart, 2009 (84) about selective beliefs), we claim that “*Poor*” subjects opportunistically choose the fairness ideal that benefits them most (“*Rich*” should contribute more) justifying in this way their selfish behavior (contributing less). On the other hand “*Rich*” subjects ignore signals that cause their posterior beliefs to conflict with their self interest. Therefore, for the latter, the relative initial laboratory endowment is more important than the relative out-of-lab wealth.

Finally, when comparing beliefs in figure 3 with the relative actual contributions of figure 2 we observe that, in all treatments, the average relative contributions are always less than beliefs on others’ contributions. This fact makes us think that it might be better to study the two variables in parallel.

Let us look at the relation between subjects’ beliefs on others’ obligations to contribute and the actual contribution of each subject. In order to perform meaningful comparisons between subjects with different endowments, we focus on contributions expressed as a percentage of own endowment. Figure 4 refers to subjects with high endowments. It plots the difference between each subject contribution and his/her belief of what others of the same, b_s , or the other, b_o , type should contribute. Red dots correspond to poor subjects, whereas green dots correspond to rich ones.

The diagonal line indicates that a subject believes that others of either type should contribute equal percentages of their endowments to the public good ($b_s=b_o$). The vertical (horizontal) line shows the level of own contributions which are equal to the subject belief of

¹⁷The corresponded Wilcoxon test is significant in 10% significant level.

3.4. RESULTS

Figure 3.4.: High-Endowment Subjects (endow20)

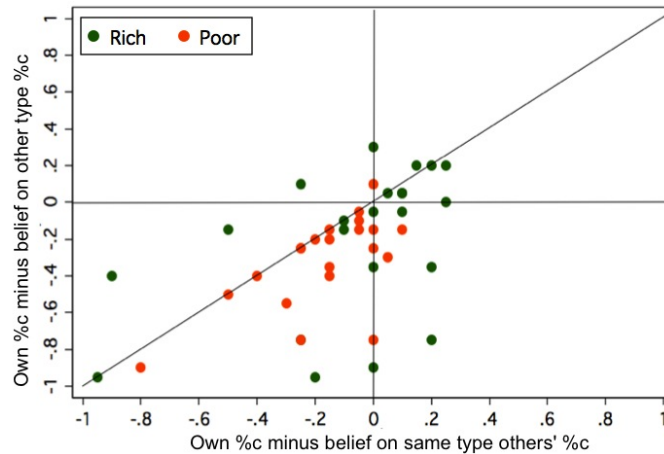

what others of the same (other) type should contribute. The area below the diagonal line and to the left of the vertical one corresponds to subjects whose actual contribution is less than what they believe their similars should contribute, while they expect subjects of the other type to contribute more than themselves. A fortiori, these subjects contribute also less than they expect subjects of the other type to contribute. In this area, we find the vast majority of poor subjects and only exceptionally some of the rich ones.¹⁸ On the contrary, rich subjects are scattered among the four quadrants with slightly higher frequency in the upper right area of higher contributions than what expected from others of any type.

In few words, poor subjects tend to adopt the most irresponsible and selfish attitude of someone who expects others to contribute more than what he actually is prepared to do himself. There are two things that can be learned from this result. First, real wealth should be taken into account because it may affect subjects' beliefs and actions. Second, information on player's real income will serve as an excuse for the poor to develop a selfish behavior which deviates even from their own moral standards.

When we look at the same type of figure for subjects with low endowments, the picture becomes less clear, because now some of the poor subjects are found in the upper right

¹⁸A similar pattern is obtained in a baseline session in which subjects' incomes are elicited but not made public to the participants. Although this is established with a much smaller sample, it indicates that it is the real income and not the announcement responsible for this effect.

Figure 3.5.: Low-Endowment Subjects (endow10)

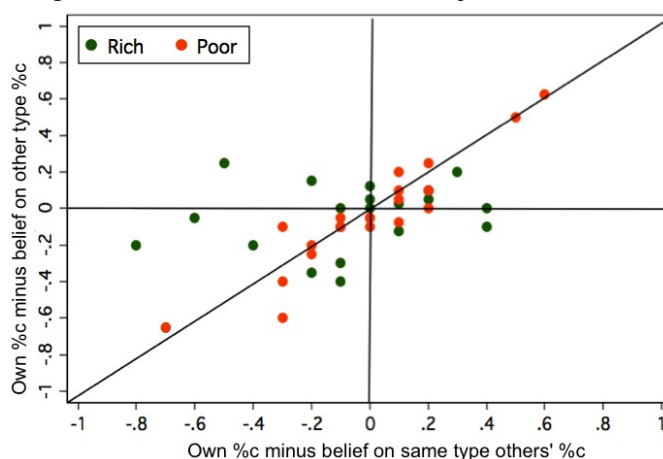

quadrant. It seems that these subjects behave in an over-responsible way contributing more than others, despite the fact that they are poorer out of the lab and are worse endowed in the experiment. Therefore, while a higher endowment to poor subjects seems to lead to an excessively selfish behavior, a lower endowment makes some of the poor subjects to behave in the most generous way possible, maybe in an effort to generate more of the public good, and, thus, increase their earnings. Interestingly, poor subjects form the same beliefs on the contributions of both high and low-endowed subjects (i.e. in figure 5, red dots are close to the diagonal).

We have estimated alternative econometric models in which the dependent variables are departures of a subject's absolute (relative) contribution from his/her absolute (relative) beliefs on what others of the same or the other type, respectively should contribute. Differences between normative expectations and actual behavior could be considered as the result of dissonance between a subject's moral standards and actions or may reflect a subject's concerns for a fairer distribution of wealth. Finally, such differences may simply be the result of conflict between one's own *homo politicus* and a more strategic *homo oeconomicus* (see Nyborg 2000(80)).

3.4. RESULTS

Table 2: REGRESSIONS ON CONTRIBUTIONS

<i>Variable</i>	$ c - b_s $	$\%(c - b_s)$	$\%(c - b_o)$
	3(a)	3(b)	3(c)
<i>info</i>	-4.59*** (.58)	-.32*** (.04)	-.23*** (.04)
<i>design</i>	1.27*** (.22)	.76*** (.02)	.04 (.04)
<i>hetero2</i>	5.05*** (.60)	.32*** (.04)	-.12*** (.02)
<i>hetero4</i>	6.84*** (.85)	.47*** (.06)	
<i>endow20</i>	-4.51*** (1.07)	-.24*** (.07)	-.29*** (.06)
<i>rich</i>	-1.66* (.86)	-.13* (.06)	-.04 (.05)
<i>rich20</i>	4.38*** (1.17)	.27*** (.06)	.13 (.11)
<i>constant</i>	.41 (1.2)	.08 (.08)	.28 (.15)
N	94	94	82

* significant at 10%; ** significant at 5%; *** significant at 1%

While our specification cannot distinguish between these alternative explanations, our estimates give us interesting hints about the underlying motivators of the observed behavior. Comparing variables' coefficients and significances of $|c - b_s|$ and $\%(c - b_s)$ with the ones in table 1 of the previous section we notice many similarities: the robust negative effects of relative wealth information and of the high endowment given to *Poor* subjects and the robust positive effect of heterogeneity. Being rich and highly endowed (in comparison to being poor and poorly endowed) not only keeps its positive effect on the dependent, in each case, variable but also makes it more robust¹⁹. Moreover, for the first time the origin of endowment has a significant ($p < 0.01$) effect. Endowing subjects by design and not randomly has a positive effect on a subject's (relative and absolute) contribution deviation from his/her belief on others of same type.

¹⁹Robustness maintains its strength even when cluster specification is not used in the regression (see Appendix 2)

Finally, when the distance between relative contributions and b_o is measured, the homogeneous treatments are excluded from the sample. For this reason, the dummy variable *hetero4* is now excluded and is used as the control group. *Hetero2* turns negative because it is compared not to homogeneity but to *hetero4*. Moreover, the effect of *design* is neutralized once more and endowment effects holds only for *poor* subjects.

3.5. CONCLUSIONS

Endowment heterogeneity in the lab has been studied together with wealth heterogeneity outside the lab. We have found that heterogeneity in the lab affects both absolute and relative contributions positively, contradicting results from previous experimental studies finding negative or no effect (i.e. Anderson et al., 2008(66), Buckley and Croson, 2006(69), Cherry et al., 2005(74) etc.) of heterogeneity.

Incorporating real out-of-lab heterogeneity in our analysis, at a first glance, did not give any significant results. However, from the interaction between out of lab and laboratory-induced heterogeneity interesting results have been obtained. High endowments lead to higher contributions (both $|c|$ and $\%c$) only the relatively richer people. Being relatively poor outside the lab makes highly endowed subjects contribute relatively less (but the same in absolute terms). This finding made us believe that *Poor* and *Rich* subjects have a different way of facing the same situation.

Trying to shed light to this aspect, we analyzed subjects' beliefs about others' contributions. We see that almost all subjects (with the exception of *Rich10* in RP20 and DP20) no matter their types, they expect that subjects of the other type will contribute more. As mentioned in Dana et al. (2006) (75): *Subjects may feel compelled to give in some situations, because they do not want to appear selfish either to themselves or to others. Thus, the underlying motivation driving much fair behavior might be self-interest, coupled with a desire to maintain the illusion of not being selfish. This means that the same people who give [...] may actual prefer the self-regarding and unfair outcome, as long as they have an excuse not*

3.5. CONCLUSIONS

to have to give.

In our design, apart from the experimental anonymity protocols which secure that subjects do not appear selfish to others, it has also given to *Poor* subjects the excuse not to have to contribute to the Public Good and therefore not to appear selfish even to themselves. The fact that they are *Poor* and more importantly, that this is both confirmed and common knowledge from everybody, gives them the excuse to adjust their beliefs and finally to contribute less compared to *Rich*. On the other hand, *Rich* subjects do not perceive or simply avoid such an “excuse ”since it drives them to higher contributions and probably to lower profits.

INTERGENERATIONAL TRUST TRANSMISSION: THE EFFECT OF ENDOGENOUS PUNISHMENT

Abstract

In¹ an overlapping generations trust game with punishment, where there is cultural transmission of preferences, we investigate the interaction and the evolution between the preferences for reciprocity of the allocator and the feasibility and willingness to punish hostile behavior by the investor. The long run behavior of this society which results from the stable steady states of the dynamics, characterizes different cultures. We focus on the effect of the punishment capacity of the society, as a major determinant for the successful implementation of a Fully Cooperative Culture leading to the social efficient outcome. Our main result states that if punishment capacity is high enough and its unity cost low, the economy will converge from any initial condition to an efficient cooperative equilibrium. Finally, when punishment capacity is endogenized the most efficient outcome is achieved faster and with higher probability.

4.1. INTRODUCTION:

It is well established in the literature that high levels of trust among people have clear positive economic and social effects (Knack and Keefer, 1997(107), Knack and Zak, 2001(108)).

¹This chapter is part of a joint work with Vicente Calabuig and Gonzalo Olcina from the Universidad de Valencia.

4.1. INTRODUCTION:

That is why public policies around the world are designed to promote trust among members of the society. It is also well known that informal punishment institutions functioning as norm enforcement mechanisms are effective in sustaining cooperation by punishing the violators (Fehr and Gaechter, Nature paper). Still again, not always such a mechanism is effective (Herrman, Gaechter and Tohni). It is therefore reasonable to query why societies develop different levels of trust through generations and when such punishment mechanisms are effective.

As a workhorse in the present study we make use of an extended version of the well-known trust game by Berg et. al (1995) with an additional punishment stage. In this two-person game, the “investor” is given a choice of participating or not in an investment which results to a positive outcome, which initially comes into “allocator’s” possession. The latter decides, in a second stage, which proportion (if any) of this profit to return to the investor. Any money the allocator does not return may be kept. Finally, in a third punishment stage, investor decides which proportion (if any) of allocator’s total wealth is willing to destroy at a given unitary cost (z).

This game represents a more general situation in which a party can hold up on the other, but the latter can punish the non-compliant player. In fact the extended trust game with punishment (TGP) can simulate many social and economic bilateral situations in labor markets and international trade. In labor market², employees (as investors in the TGP) and employers (as allocators in the TGP) are "tied" together as they invest in relation-specific assets. The possible retaliatory power (punishment) of workers would be legal strikes and/or to practice a slowdown in production, "illegal" sabotage, etc. International markets (see Bagwell and Staiger, 2009(89) and Rhodes, 1993(116)) provide another economic situation corresponding to TGP conditions. The World Trade Organization (WTO) has managed to achieve a high level of trust among its members by activating the General Agreement on Tariffs and Trade (GATT), which includes a series of punitive sanctions if a member deviates from the

²Along this line, in an empirical study by Aghion, Algan and Cahuc (2008)(86) it is observed a strong positive correlation between unionization rates and the level of trust (based on self reported answers) in labor relationships in cross country regressions.

agreement.

Given that existing “cooperative” preferences within a society are not sufficient to obtain and maintain high levels of trust, the central focus of this study is to analyze the main determinants of punishing institutions which could possibly result on higher levels of trust and consequently on higher economic outcomes. Apart from the impact that cost of punishment has upon its effective use (Rigdon, 2009(115), Nikiforakis, 2008(112), Gintis, 2008(105), Carpenter, 2007(95)), here we also turn our attention to the punishment capacity. Punishment Capacity refers to the maximum proportion of the surplus of the target of the punishment, which can be destroyed by punishers at a given cost. In other words, punishment capacity could be viewed as the institutions’ limits. For example in many cases, even if agents are willing to destroy all the surplus of the norm violator, institutions do not offer such option either deliberately (bribing, corruption, etc.) or unintentionally (bureaucracy, incapacity, etc.).

Based on Olcina and Calabuig (2008)(113), we move a step ahead and study the intergenerational transmission of such norms. In particular we consider two distinct types of preferences; selfish and inequity-averse. The distribution of these types might affect the cooperating or defecting outcomes in an intergenerational TGP. So, in every period there is a given fraction of selfish and reciprocal agents. The distribution of preferences in each population evolves according to a process of cultural transmission which combines (i) direct transmission from parents and (ii) oblique transmission from the society (Cavalli-Sforza and Feldman, 1981(96), Boyd and Richerson, 1985(90)). Parents transmit their own preferences by (costly) investing on their offspring education (Bisin and Verdier, 2001). If they do not succeed, children acquire preferences from the social environment. However, in contrast with the basic assumption of the aforementioned seminal paper by Bisin and Verdier (2001)(92), where oblique transmission takes place in society at large, here we assume *cultural isolation*: investors’ (allocators’) offspring are socialized, either by their parents or by other adult investors (allocators).

Since our basic result suggests that punishment capacity (λ^*) is a very crucial determinant

4.1. INTRODUCTION:

for achieving “cooperative” outcomes through generations, we move a step forward and introduce two different implementation mechanisms (regarding capacity) which represent two different political regimes. In the first one, society’s punishment capacity is determined exogenously by a social planner and all agents have no option but to follow it. In this case (which reminds practices followed by authoritarian regimes) we investigate how different types of agents (selfish or fair-minded) adjust their strategies, actions and education effort for maximizing their own and their offsprings utilities given the predetermined capacity level. In the second case we endogenize punishment capacity and now agents are allowed to vote (using a simple majority rule) for the capacity level they wish to implement in their society. In this case (simulating a more democratic society) we also focus in analyzing the incentives of different types of agents during the voting process.

The interplay among the aforementioned implementation mechanisms of λ^* , the exogenously determined parameters’ values of the model (i.e. punishment cost (z), inequity averse parameters (α, β)) and the different departing points of a generation (characterizing the distribution of its preferences) leads to a variety of results and conclusions regarding actions, strategies, distributions of preferences and equilibriums. However, it is proven that any given generation is going to be driven into (at least) one stable steady state of the cultural dynamics where the same Perfect bayesian Equilibrium of the TGP is played. Adhering the notion of culture by Rob and Zemsky (2002)(117), we define three *cultures* which can possibly persist in the long run.

First, when the capacity of punishment is sufficiently high and the cost of punishment is sufficiently low, it is obtained what we denote as a Fully Cooperative Culture (FCC). This is the efficient steady state of cultural dynamics: all investors make the investment and all allocators pay high (fair) returns, and therefore there is no punishment and surplus destruction. In this culture is obtained a high level of aggregated investment (trust) in the society. This can only happen with a relatively high fraction of inequity averse investors but it does not depend on the preference distribution in the allocators population.

Second, there is a Quasi Cooperative Culture, with a both intermediate capacity of punishment and an intermediate cost of punishment, in which both types of investors choose to make investments, but selfish allocators offer low return while reciprocal allocators offer high rewards. Notice that this is an inefficient equilibrium because fair-minded investors punish the low rewards offered by selfish allocators destroying the maximal possible amount of surplus. This culture exists for a society with a relatively high proportion of selfish investors (more than 50%) and a low proportion of selfish allocators. The combination of this intermediate balance of power and an initial condition with relatively many selfish investors and not so many selfish allocators results in the society getting stuck in the QCC.

Finally, there is a third culture, the Inefficient Separating Culture (ISC), characterized by a low capacity of punishment and/or a high cost of punishment, in which the selfish investor chooses to make the investment and the reciprocal investor chooses not to make it. Selfish allocators set low reward while reciprocal allocators set high (fair) returns. Selfish investors play cooperatively because of the presence of a significant fraction of fair-minded allocators who pay high returns and inequity averse investors choose not to make an investment because of the presence of a significant fraction of selfish allocators who pay low returns. Notice that this culture is very inefficient since there exists a small fraction of selfish investors that make investment, the majority of reciprocal investors decide not to invest, resulting in a low level of aggregate investment (trust). Therefore there are countries that can be stuck in a culture with low trust although with high proportion of reciprocal investors given the fear of this latter to be held up by the high proportion of selfish allocators.

Finally, the endogenous choice of punishment capacity have several impacts on the determination of the final prevalent culture.

1. The ISC is no longer feasible. With the election of the adequate λ^* , all agents will end up either to FCC or to QCC, no matter the initial distribution of preferences or the the exogenous parameters of the model.
2. The dynamical convergence to FCC is achieved faster or even immediate. All agents

4.1. INTRODUCTION:

are coming closer to FCC as soon as high λ^* is the outcome of the election. Moreover, when inequity averse are more than selfish investors passing from ISC or QCC to FCC is immediate.

3. Some generations trapped into QCC will never manage to escape even with endogenous λ^* . This is the case when selfish are more than inequity-averse investors.
4. Given that agents are short-sighted, some generations, in their attempt to escape from ISC, will also be trapped into QCC.

The basic conclusion, which can be drawn from the above analysis, is that the “democratization”, leads to the election of sufficient high punishment capacity which in its turn affects positively the level of trust and therefore the efficiency of a society. Nevertheless, even an authoritarian planer could possibly manage to achieve efficiency by imposing high punishment capacity in the society. Our argument here is that the punishment capacity in our model represents not the “nominal” capacity stated by any planer (democratic or not) but the actual one which is commonly, or by the majority, believed and accepted. Given that authoritarian or totalitarian regimes are usually not approved by majority, while at the same time a minority is treated favorably, we believe that the actual punishment capacity is small, even if it is declared high.

Finally, before starting the detailed analysis of our model, it is necessary to make clear the sequence of the events. We consider overlapping generations of agents who only live two periods. During the first period, the agent is a child who is simply being educated from his³ parents and the close neighborhood. In the second period, the agent who is now an adult with well-defined preferences resulted from the socialization process, has now himself a child and he takes two actions. He plays the extended trust game with another randomly matched agent while at the same time he decides about the education effort devoted to his child. In section 7 of this study, the election of the punishment capacity of the economy is

³Although reproduction is asexual we use “he” for simplification reasons

endogenized and therefore, an additional stage of voting is necessary to be incorporated in the second period of agents' life. Before agents play the TGP and educate their children, they vote for the desired punishment capacity.

In order to analyze our model and find the Perfect Bayesian Equilibriums and the corresponding Cultures mentioned above, backward induction method is necessary to be applied. We, thus, start our analysis, in section 2, from the description of the last component of our model, the extended trust game. In section 3 we introduce the notion of inequity-averse preferences and we analyze the behavior of inequity averse agents. Section 4 studies the extended trust game with heterogeneous preferences in both populations. Section 5 summarizes the mechanism of cultural transmission of preferences. In section 6, we characterize the steady states or long run cultures under the cultural dynamics and their basins of attraction. In section 7 institutional punishment capacity is endogenized and long run cultures are recalculated. Finally, section 8 concludes.

4.2. THE TRUST GAME WITH A PUNISHMENT PHASE (TGP).

For the characterization of the level of trust in our population, we use an simplified (on choices and payoffs) version of the well-known experimental Trust Game by Berg et al. (1995) with an additional punishment stage. In this two-person game, the "investor" is given the binary choice of investing (I) or not investing (NI). Only in the former case, a total surplus of "1" is produced which pass to "allocator's" possession. However, if investor does not invest, the game ends and both players obtain a payoff of zero. In the second stage, the allocator, after observing I , he/she returns a proportion $0 \leq b \leq 1$ to investor. Finally, in a third stage, b is observed by investor who then has the option of punishing the allocator at some unitary cost z for him. In particular, the investor can choose to destroy a proportion λ of the allocator's payoff $(1 - b)$, where $0 \leq \lambda \leq \lambda^* \leq 1$ and $0 \leq z \leq 1$.

Thus, the final material payoffs for investors and allocators respectively are:

4.2. THE TRUST GAME WITH A PUNISHMENT PHASE (TGP).

- $P_I = b - z\lambda(1 - b)$
- $P_A = (1 - b)(1 - \lambda)$

The incorporation of punishment in the TG add two very important elements in our analysis. The first one, z , is investors' unitary cost of punishing and it corresponds to the cost of detecting and indicting a defective action or to the cost of implementing the punishment. The second one, λ^* is referred to the punishment capacity, the maximal permitted destruction of allocator's surplus, where $0 < \lambda^* \leq 1$.

Apart from the labor⁴ and international market examples described in the introduction, the structure and the effectiveness of societies' legal systems consist a good example for describing the meaning of z and λ^* . Depending on the corruption level and the bureaucracy of a legal system, the cost z can vary as it might be very time consuming for an agent to indict the defector. Additional to this, different λ^* imposed by the law, allows for different proportions of allocator's surplus to be destroyed. It is obvious, though, that when λ^* is small the implicit threaten of punishment is not that high and therefore not that deterring. The parameter λ^* could also be referred to the effectiveness of the legal system (or to the common belief over effectiveness). In this very interesting case λ^* corresponds to the probability of the fair-implementation of the law by a planer. Even if the law is very strict by allowing the total allocator's surplus to be destroyed, the probability of the law to be implemented might be very low and therefore the threaten of punishment very weak.

Moreover, assuming that all agents in the economy have self-regarding preferences, it is easy to obtain the Subgame Perfect Equilibrium by performing backward induction. Starting from the point that a profit maximizer investor is not willing to spend any money for punishing, as such an action simply decreases his/her payoff, we actually end up to the Subgame Perfect Equilibrium of the formal TG by Berg et al. (1995). As allocator discerning the incredibility of investor's threaten, he/she offers nothing ($b = 0$) to the investor. Investor,

⁴In this case, z varies with the firm's capability of finding out and sanctioning sabotage or with the difficulty of coordination and organization in case of strikes, while λ^* would be the maximal punishment that a worker can inflict on the firm

being the first mover, anticipates allocator's action and he/she does not invest anything (NI).

Nevertheless, in this study we assume heterogeneity of preferences. Apart from self-regarding agents there are also a significant proportion of "fair-minded" agents who exhibit social preferences. Next section describe such preferences.

4.3. SOCIAL PREFERENCES: INEQUITY AVERSION.

Overwhelming evidence generated by the experiments in the laboratory and also everyday's experience, suggest that fairness and reciprocity motives affect the behaviour of many people. We will assume that in the initial condition of the society in which there are two groups or populations, investors and allocators, there is a certain proportion of people in each group with selfish preferences and the remaining proportion with reciprocal preferences.

We suppose that in the population of allocators, there is a fraction of "rewarders" or fair-minded allocators characterized by having a dominant action, which is to share equally the surplus, i.e. they always return $b = 1/2$. On the other hand, in the population of investors there is a fraction of "punishers" which are willing to punish "unfair" offers ($b < 1/2$) provided that the cost z is low enough. The remaining population in each group has selfish or self regarding preferences.

A number of theoretical models have been developed in the literature to obtain reciprocal behaviour. Well-known examples include Fehr and Schmidt (1999) and Bolton and Ockenfelds (2000)'s models of inequity aversion, Charness and Rabin (2002)'s model of quasi-maximin preferences, Rabin (1993) and Dufwenberg and Kirchsteiger (2004)'s models of intention-based reciprocity. These models can lead to different predictions in some particular games, but in our modified sequential prisoners' dilemma (extended trust game) they all deliver reciprocal behaviour. For tractability reasons, we choose in this work the inequity aversion preferences model of Fehr and Schmidt (1999) but the results would not change qualitatively with any other type of efficiency-enhancing social preferences as those previously mentioned.

4.3. SOCIAL PREFERENCES: INEQUITY AVERSION.

By reciprocity we mean the willingness to reward friendly behaviour and the willingness to punish hostile behaviour. Inequity averse allocators are very generous in compensating the cooperative action of the investor (willing to share equally the surplus). An inequity averse investor will punish a low rewarding policy by the allocator, provided that the unit cost of punishment is low enough. The presence of inequity averse agents might produce changes in the behaviour of selfish agents.

In our paper the distribution of preferences in both populations of economic agents in each period is endogenously determined by the decision made by adult players. In each "social" class or group, there is a certain proportion of people with selfish preferences and the remaining proportion with reciprocal preferences. In particular, in the investors' (allocators') population there is a proportion x_t (y_t) of self-interested (selfish) agents in period t who are motivated exclusively by their own monetary payoffs and a proportion $1 - x_t$ ($1 - y_t$) of agents who exhibit reciprocity (inequity aversion) in their observed behaviour.

Let $m = (m_1, m_2)$ denote the vector of monetary payoffs for both players. The utility function of an inequity averse player i is given by:

$$U_i(m) = m_i - \alpha \max\{m_j - m_i, 0\} - \beta \max\{m_i - m_j, 0\}, \quad j \neq i, \quad \text{where } \beta \leq \alpha \text{ and } 1 > \beta \geq 0.$$

Inequity averse agents are willing to give up some material payoff to move in the direction of more equitable outcomes. The second term in the above expression measures the utility loss from disadvantageous inequity, while the third term measures the loss from advantageous inequity. The assumption $\beta \leq \alpha$ implies that a player suffers more from inequity that is to his disadvantage, that is, the inequity aversion is asymmetric. We also assume that $\beta > 0.5$ and denote this type of players as strongly inequity averse players.

Strongly inequity averse players have very different policies as compared to those of selfish players, in particular the rewarding policy of the allocators and the punishment policy of investors. The inequity averse allocators compensate generously the cooperative action of the investors and the inequity averse investors are willing to punish a low rewarding policy by the allocators, provided that the unit cost of punishment is low enough. Let us prove these

policies in turn.

4.3.1. PUNISHMENT POLICY OF STRONGLY INEQUITY AVERSE INVESTORS.

In contrast to the behaviour of selfish investors, the threat of punishment is credible in the case of inequity averse investors, provided that the unit cost of punishing z is smaller than a critical value which is increasing in α , the parameter that captures his degree of disadvantageous inequity aversion.

Assume $z \leq \bar{z} = \frac{\alpha}{1+\alpha}$, if the inequity averse investor is offered a reward $b \geq 1/2$ by the allocator, he will not punish her. If the allocator offers a reward $b < 1/2$, the investor will punish her with a punishment that depends inversely on the compensation offered by the allocator.

In particular, if the investor is offered a reward of b , where $0 \leq b \leq b^* = \frac{1-\lambda^*+\lambda^*z}{2-\lambda^*+\lambda^*z}$, he will punish the allocator choosing λ^* , the maximal possible punishment.

If the investor gets an offer b , where $b^* < b < 1/2$, he will punish the allocator choosing $\lambda = \frac{1-2b}{(1-z)(1-b)} < \lambda^*$.

Proof. See Appendix. □

The intuition behind this result is that by punishing, the inequity averse investor, reduces inequality against him and this positive effect more than compensates the diminution in his material payoffs. Notice that in principle, the inequity averse investor will punish his allocator until an egalitarian payoff vector is obtained. But if the return offered by allocator is very small, an egalitarian payoff is not feasible because there is a limit in the amount of punishment λ^* . And in this case, the investor punishes until this limit is reached.

4.3.2. REWARDING POLICY OF STRONGLY INEQUITY AVERSE ALLOCATORS.

A strongly inequity averse allocator has a dominant strategy which is to offer half of the surplus ($b = 1/2$) to the investor. This strategy implies that none of both types of investor

will punish her. Notice that starting in an unequal advantageous distribution for her, to give one monetary unit to the investor reduces her material payoff in one unit and consequently her utility. But, it also reduces the inequity in two units. Therefore, as $\beta > 0.5$, her utility increases in more than one unit. The total effect is an increase in her utility. We relegate to the Appendix a more formal proof.

4.3.3. CHANGES IN THE BEHAVIOUR OF SELFISH AGENTS.

The presence of inequity averse agents in the population induces changes in the behaviour of selfish agents. For instance, a selfish investor who faces an inequity averse allocator with probability one will choose to invest, because he knows that the allocator will offer an equitable reward.

The behaviour of a selfish allocator will also depend crucially on the type of investor that she faces. We already know that when a selfish allocator faces with probability one a selfish investor, she will offer no reward anticipating that this type of player does not punish. But when a selfish allocator faces a strongly inequity averse player with certainty, her rewarding policy will change substantially. In particular, she will offer $b = 1/2$, because she anticipates that he will punish her if she does not offer an equitable reward. This result is stated in the following lemma.

If $\lambda^* \geq 1/2$, a selfish allocator faced with probability one with an inequity averse investor, will offer a return of $b = 1/2$.

Proof. See Appendix. □

As a consequence, the inequity averse investor, anticipating this behavior of the allocator, will choose to invest, yielding the efficient outcome, a surplus of size 1.

Notice that this lemma only holds for $\lambda^* \geq 1/2$. If the investors' strength λ^* is smaller than $1/2$, that is, the investor can only destroy at most less than half of the surplus, the optimal behaviour of a selfish allocator is to offer $b = 0$. Thus, her behaviour would be the same that

in absence of the punishment option. This explains our assumption on the lower bound on λ^* .

Summarizing, if it is common knowledge that both, or at least one of the agents is inequity averse, then the investor chooses to invest and the allocator rewards him with a high return. Both the allocator and the investor will get a payoff of $1/2$.

The intuition behind these results is the following. When the allocator is an inequity averse player she behaves generously in her reward policy offering $b = 1/2$. Then, the selfish investor does not fear being exploited. On the other hand, as inequity averse investors are willing to punish any offer below $b = 1/2$, selfish allocators, anticipating this behavior, will behave also generously offering half of the surplus. Therefore, the inequity averse player will choose at the start of the game to invest, achieving the efficient outcome.

4.3.4. REWARDING POLICY OF ALLOCATORS WITH INCOMPLETE INFORMATION

Note that players do not know the true type of the player with whom they are matched with in period t . However, we will assume that they know the preferences distribution x_t or y_t in both groups. That is they know the distribution of preferences of the population from which a player is drawn. This distribution of preferences will be endogenously determined in our model by the education decisions made by adult players.

Notice, first, that the rewarding policy of an inequity averse allocator does not change when there is incomplete information. However, the rewarding policy of a selfish allocator is indeed affected by the existence of a fraction of inequity averse investors.

To compute the optimal rewarding policy of selfish allocators, note that the particular decision made by the investor might also change her beliefs about the investor's type. We will denote by $\mu_t(e/I)$ the updated probability in period t which the allocator assigns to the investor being selfish after observing the action I . Then, the selfish allocator has three options: i) to offer a low return b , such that $0 \leq b < b^*$, ii) to offer an intermediate return b , such that $b^* \leq b < 1/2$ or, finally, iii) to offer a generous reward, $b = 1/2$.

4.4. EQUILIBRIA OF THE TRUST GAME WITH PUNISHMENT (TGP).

We show in the Appendix that the second option is dominated by the other two. It is easy to see that if the allocator wishes to offer a low return, the best option is to set $b = 0$. Thus, we have to compare whether the allocator prefers to offer $b = 0$ or $b = 1/2$. The answer depends obviously on the beliefs about the proportion of selfish investors in the population. In the following lemma we state this result:

A selfish allocator will use the following rewarding policy:

- a) Offer $b = 0$ if $\mu_t > \frac{\lambda^* - 1/2}{\lambda^*}$
- b) Offer $b = 1/2$ if $\mu_t \leq \frac{\lambda^* - 1/2}{\lambda^*}$

Proof. See Appendix □

We are ready to obtain the equilibria of this extended trust game with incomplete information in the next section.

4.4. EQUILIBRIA OF THE TRUST GAME WITH PUNISHMENT (TGP).

In this section, we characterize the Perfect Bayesian Equilibria of the incomplete information sequential game played in each period. First, we obtain the efficient equilibrium of the game. All types of investors choose to invest and all types of allocators pay high (fair) returns and, therefore, there is no surplus destruction.

The Fully Cooperative Equilibrium where all investors choose to invest.

For every y_t and $x_t \in [0, \widehat{x}]$, where $\widehat{x} = \frac{\lambda^ - 1/2}{\lambda^*}$, there exists a Fully Cooperative Equilibrium (FCE) in which both types of investors choose to invest (I) and both types of allocators choose a return $b = 1/2$.*

The equilibrium payoff for all types of players is $1/2$. This equilibrium can only happen with a relatively high fraction of inequity averse investors. In particular, it exists for a proportion of selfish investors smaller than a critical value, namely, $x_t \in [0, \widehat{x}]$, where $\widehat{x} = \frac{\lambda^* - 1/2}{\lambda^*}$. A relatively high fraction of inequity averse investors is needed for the existence of this equilibrium. This type of investors credibly punishes the unfair behaviour of allocators. Thus, if

its proportion is high enough, selfish allocators are better off offering high returns and avoiding punishment. Notice that the critical fraction of selfish investors \widehat{x} depends positively on the investors' power λ^* and can take values between 0 and 1/2 for $\lambda^* \in [1/2, 1]$. Therefore, for λ^* smaller or equal than 1/2, there does not exist a fully cooperative equilibrium.

Proof. See Appendix. □

Next we will show an equilibrium in which all types of investors choose to invest, but the selfish allocators do not reward and there is surplus destruction.

The Quasi Cooperative Equilibrium where the selfish allocator offers low return.

For investors' preference distributions with a sufficiently high proportion of selfish individuals $x_t \in [\widehat{x}, 1]$ and allocators' preference distributions with a sufficiently high proportion of inequity averse individuals $y_t \in [0, y'']$, where $y'' = \frac{1}{(1+2(z\lambda^(1+\alpha)+\alpha(1-\lambda^*)))}$, there exists a Quasi Cooperative Equilibrium (QCE) in which both types of investor choose to make the investment, selfish allocators set $b = 0$ and inequity averse allocators set $b = 1/2$.*

Proof. See Appendix. □

The equilibrium utility of the selfish investor is $(1 - y)/2$, is $x + (1 - x)(1 - \lambda^*)$ for the selfish allocator, is $\frac{1}{2}$ for the inequity averse allocator and for the inequity averse investor is $(1 - y)/2 + y(-z\lambda^* - \alpha(1 - \lambda^* + z\lambda^*))$, while his material payoff is $(1 - y)/2 + y(-z\lambda^*)$.

Notice that this is an inefficient equilibrium because fair-minded investors punish the low rewards offered by selfish allocators destroying the maximal possible amount of surplus. This equilibrium exists for a society with a high proportion of selfish investors and a low proportion of selfish allocators. A high proportion of selfish investors is needed for selfish allocators to offer low returns and a low proportion of selfish allocators is needed for inequity averse investors to make specific investment, given that punishment is costly.

Next we obtain an equilibrium in which the two types of investors choose different behavior when decide to invest. Selfish investor choose to invest while fair-minded investors decide not to do it. The two types of allocators also choose different rewarding policies.

4.4. EQUILIBRIA OF THE TRUST GAME WITH PUNISHMENT (TGP).

The Inefficient Separating Equilibrium.

For every investors' preference distribution x_i and an allocators' preference distribution greater or equal than y'' , there exists an Inefficient Separating Equilibrium (ISE) in which the selfish investor chooses to make the investment and the inequity averse investor chooses not to make the investment. Selfish allocators set $b = 0$ and inequity averse allocators set $b = 1/2$.

Proof. See Appendix. □

The equilibrium payoff of the selfish investor is $(1 - y)/2$, is 0 for the inequity averse investor, is x for the selfish allocator and is $x/2$ for the inequity averse allocator. Note that, paradoxically, in this inefficient equilibrium, selfish investors choose to invest and strongly inequity averse investors do not invest. Selfish investors play cooperatively because of the presence of a significant fraction of fair-minded allocators who pay high returns and inequity averse investors choose not to make an investment because of the presence of a significant fraction of selfish allocators who pay low returns. As the punishment is costly, if the number of selfish allocators is high enough, it is not worthwhile for the inequity averse investor to invest.⁵

This explains that this equilibrium only exists for an intermediate range of $[y'', 1]$. That is, if there were too few fair-minded allocators, selfish investors would not find profitable to invest and if there were too many fair-minded allocators, then inequity averse investors would invest.

Note also that there is no separating equilibrium in which a selfish investor chooses not to invest and an inequity averse investor decides to invest. In this case, allocators would offer high returns ($b = 1/2$), and selfish investors would deviate, imitating the behaviour of their inequity averse mates.

⁵A similar result is obtained in Fehr, Klein and Schmidt (2007) in a principal agent model. The presence of fair principals induces selfish agents to choose high effort levels, while the presence of selfish principals induces the fair agents to provide low effort levels..

Finally, there is also a very inefficient equilibrium in which both types of investors decide not to invest.

The Non-cooperative Equilibrium where investors do not invest.

*For every investors' preference distribution x_i and the degenerate allocators' preference distribution $y_i = 1$, there exists a Non-cooperative equilibrium (NCE) in which both types of investor choose not to invest.*⁶

Proof. See Appendix. □

The equilibrium payoff for all types of players is 0. As we will assume always interior initial conditions in our dynamic analysis and as it can be easily shown that this equilibria are unstable steady states, we will not consider the NCE in what follows.⁷

Notice that for $x \leq \hat{x}$ and $y \geq y''$, there is multiplicity of equilibria. In the following we will assume that all players select the FCE, because it Pareto-dominates the ISE. If the society is in this region, we will assume that all agents expect and coordinate in the Pareto dominant equilibrium.

We can divide the space of pairs of preference distributions (x, y) in four regions, according to the expected and actual equilibrium (where recall that the FCE only exists for $\lambda^* > \frac{1}{2} \rightarrow \hat{x} > 0$).

4.5. THE SOCIALIZATION PROCESS AND THE EDUCATION EFFORT BY PARENTS IN A SEGMENTED SOCIETY.

Human behaviour is governed by preferences that are transmitted through generations and acquired by learning and other ways of social interaction. The transmission of preferences which is the result of social interaction between generations is called cultural transmission.

⁶If we assume that, instead of normalizing the surplus to 1, if the surplus of investing is H and the surplus of not investing is $2l$, where $H > 2l$, then this equilibrium would exist for $y_i \in [\bar{y}, 1]$, where $\bar{y} = \frac{H-2l}{H}$.

⁷The allocators' beliefs in this equilibrium are such that if they observe investment they will infer that this action is more likely to come from a selfish investor.

4.5. THE SOCIALIZATION PROCESS AND THE EDUCATION EFFORT BY PARENTS IN A SEGMENTED SOCIETY.

Figure 4.1.: Equilibrium Regions

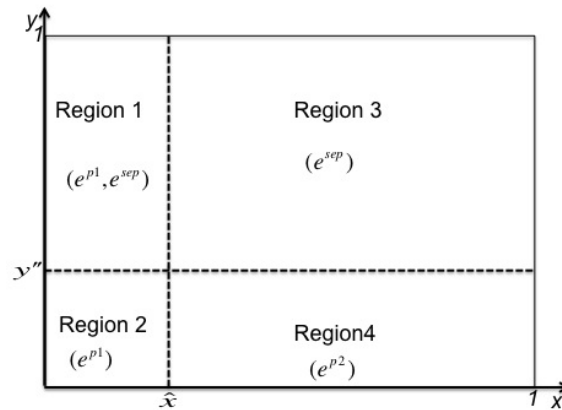

We will draw from the model of cultural transmission of Cavalli-Sforza and Feldman (1981) and Bisin and Verdier (2001).

We consider overlapping generations of agents who only live two periods (as a young and as an adult). The agents can be or investors either allocators and we assume that each type of agent belongs to a group. In the first period, the agent is a child and is educated in certain preferences, and in the second period, the agent (as an adult with well-defined preferences), is randomly matched with an adult player from the other group, to play the extended trust game described in the second section. In this second period, any adult player has one offspring and has to make a (costly) decision regarding his/her child education, trying to transmit his/her own preferences.

As it is customary in this class of models we will assume that reproduction is asexual, with a parent per child and thus the population remains constant.

In this paper there is a two-speed dynamics. On the one hand, change in preferences are gradual while changes in the behavior is instantaneous to maintain equilibrium play. Therefore, in each period individuals from both social groups coordinate in the PBE of the extended trust game and, assuming adaptive expectations, they believe that this equilibrium will be played by the next generation. However, the distributions of preferences (x_t, y_t) will evolve according to a purposeful and costly socialization process that we describe next.

Parents' purposeful and costly socialization determines the distribution of preferences in

both populations of allocators and investors. Children acquire preferences through observation, imitation and learning of cultural models prevailing in their social and cultural environment, that is, in their family and in their social group.

Let $\tau_j^i \in [0, 1]$ be the educational effort made by a parent of class j of type i where $j \in \{1, 2\}$, 1 denotes investor and 2 allocator and where $i \in \{e, a\}$, e denotes selfish and a denotes strongly inequity averse.

The socialization mechanism works as follows. Consider a parent with i preferences. His child is first directly exposed to the parent's preferences and is socialized to this preferences with probability τ_j^i chosen by the parent (vertical transmission); if this direct socialization is not successful, with probability $1 - \tau_j^i$, he is socialized to the preferences of a role model picked at random in a population composed exclusively of members of the same "social group" (oblique transmission). In this latter aspect we depart from the usual approach in which oblique transmission takes place in society at large. We call this process as the socialization process in a segmented society.

Let P_j^{ik} denote the probability that a child of a parent of a social group j with preferences i is socialized to preferences k . The socialization mechanism in group j is then characterized by the following transition probabilities where v_t is the proportion of selfish types in this social group (v_t is x_t for investors and y_t for allocators):

$$\begin{aligned} P_{jt}^{ee} &= \tau_{jt}^e + (1 - \tau_{jt}^e)v_t \\ P_{jt}^{ea} &= (1 - \tau_{jt}^e)(1 - v_t) \\ P_{jt}^{aa} &= \tau_{jt}^a + (1 - \tau_{jt}^a)(1 - v_t) \\ P_{jt}^{ae} &= (1 - \tau_{jt}^a)v_t \end{aligned}$$

Given these transition probabilities it is easy to characterize the dynamic behavior of v_t :

$$v_{t+1} = [v_t P_{jt}^{ee} + (1 - v_t) P_{jt}^{ae}]$$

Substituting we obtain the following equation on differences:

$$v_{t+1} - v_t = v_t(1 - v_t)[\tau_{jt}^e - \tau_{jt}^a]$$

Note that this cultural transmission mechanism combines direct purposeful transmission

4.5. THE SOCIALIZATION PROCESS AND THE EDUCATION EFFORT BY PARENTS IN A SEGMENTED SOCIETY.

with oblique transmission. Direct transmission is justified because parents are altruistic towards their children. But, an important feature is that they have some kind of imperfect altruism: their socialization decisions are not based on the purely material payoff expected for their children but on the payoff as perceived by their parents according to their own preferences. This particular form of myopia is called imperfect empathy (Bisin and Verdier, 2001). As a consequence, the cultural dynamics is not necessarily payoff-monotonic.

Direct transmission is also costly. Let $C(\tau_j^i)$ denote the cost of the education effort τ_j^i , $j \in \{1, 2\}$ and $i \in \{e, a\}$. While it is possible to obtain similar results with any increasing and convex cost function we will assume, for simplicity, the following quadratic form $C(\tau_j^i) = (\tau_j^i)^2/2q$, with $q > 0$. Therefore, a parent from group j of type i chooses the education effort $\tau_j^i \in [0, 1]$ at time t , which maximizes

$$P_{jt}^{ii}(\tau_j^i, v_t)V_j^{ii}(v_{t+1}^E) + P_{jt}^{ik}(\tau_j^i, v_t)V_j^{ik}(v_{t+1}^E) - (\tau_j^i)^2/2q.$$

Where P^{ij} are the transition probabilities and V_j^{ik} is the utility to a parent of group j with preferences i if his child is of type k . Notice that the utility V_j^{ik} depends on v_{t+1}^E , which denotes the expectation about the proportion of selfish players in period $t + 1$ in your own social group. In this work we will assume that parents have adaptive or backward looking expectations, believing that the proportion of selfish players will be the same in the next period that in the current period, that is, $v_{t+1}^E = v_t$.

Maximizing the above expression with respect to τ_j^i , $j \in \{1, 2\}$ and $i \in \{e, a\}$, we get the following optimal education effort functions⁸:

$$\tau_j^{e*}(v_t) = q \cdot \Delta V_j^e(v_t) \cdot (1 - v_t)$$

$$\tau_j^{a*}(v_t) = q \cdot \Delta V_j^a(v_t) \cdot v_t$$

Here $\Delta V_j^e = V_j^{ee} - V_j^{ea}$ and $\Delta V_j^a = V_j^{aa} - V_j^{ae}$. That is, ΔV_j^i is the net gain from socializing your child to your own preferences. It can also be interpreted as the cultural intolerance of parents with respect to cultural deviation from their own preferences. According to the imperfect empathy notion, parents obtain a higher utility if their children share their preferences, so

⁸In order to have interior solutions the parameter q must be chosen small enough so that in equilibrium $\tau_j^i < 1$.

these levels of cultural intolerance are non-negative.

In the following subsection we compute these levels of cultural intolerance in PBE equilibrium regions for both types of players.

4.5.1. LEVELS OF CULTURAL INTOLERANCE

We need to know the optimal level of education that parents choose in each period. In order to do so we have to compute the net gains for parents of transmitting their own preferences that are given by expression V_j^k . We know that ΔV_j^e and ΔV_j^a reflects the degree or level of cultural intolerance or distaste of parents with respect to cultural deviation from their own preferences. In this section we show that all the levels of cultural intolerance are non-negative for any expected equilibrium, i.e. $\Delta V_j^i \geq 0$ for all i and j .

The optimal education effort functions of both types of parent depend (positively) on their level of cultural intolerance and (negatively) on the proportion of their own type in the current preferences distribution in their own group.

Substituting the optimal education efforts in the differences equation that characterizes the dynamic behavior of x_t and y_t we obtain:

$$v_{t+1} = v_t + v_t(1 - v_t) \cdot q \cdot [\Delta V_j^e \cdot (1 - v_t) - \Delta V_j^a \cdot v_t].$$

This is the Bisin-Verdier cultural dynamics. We characterize the potential stable steady states or nodes of the dynamical system defined by a non-linear differences equation system.

As it is shown by Montgomery (2008) this cultural dynamics is analogous to the replicator dynamics if we substitute the material payoffs by the levels of cultural intolerance, what governs the dynamic evolution of the preference dynamics.

Next, we calculate the levels of cultural intolerance ΔV_j^i for the different PBE regions. Recall that when $y \geq y''$ and $x \leq \widehat{x}$ there is multiplicity of equilibria (ISE and FCE) but we will assume that players coordinate in efficient one, that is, the FCE.

4.5. THE SOCIALIZATION PROCESS AND THE EDUCATION EFFORT BY PARENTS IN A SEGMENTED SOCIETY.

LEVELS OF CULTURAL INTOLERANCE IN THE FCE REGION.

In this region, the proportion of selfish investors in the population is relatively small ($x \leq \widehat{x}$) and parents (investors and allocators) play and expect to be played the Full Cooperative equilibrium, in which both types of investors choose to invest (I) and both types of allocators choose to offer $b = 1/2$.

Notice that $V_j^{ik} = 1/2$ for all types of parents. Therefore, the net gains for any type of parent of any social group obtained from transmitting their own preferences ΔV_j^{ik} , that is, their levels of cultural intolerance, are zero. But this in turn implies that there are not incentives at all for socialization for any parent. Therefore, all the optimal education effort functions are zero and consequently, the distribution of preferences in both populations will remain unchanged, that is $x_{t+1} = x_t$ and $y_{t+1} = y_t$. These results are reflected in the following lemma.

If $\lambda^* > 1/2$ and for any (x, y) such that $x \leq \widehat{x}$ (i.e in the FCE region), then $\Delta V_j^i = 0, \forall i, \forall j$. Therefore $\tau_j^i = 0, \forall i, \forall j$.

For $\lambda^* > 1/2$, any pair of distribution (x, y) such that $x \leq \widehat{x}$ is a stable steady-state of the cultural dynamics.

Summarizing, in this case there are no incentives to socialize and each of the two populations remains locked in the initial distribution of preferences.

In the following subsections we will show that there is a unique stable steady state in each region, denoted as (\acute{x}, \acute{y}) in the QCE region and (\bar{x}, \bar{y}) in the ISE region.

LEVELS OF CULTURAL INTOLERANCE IN THE QCE REGION.

In this region, where $y < y''$ and $x \geq \widehat{x}$, there is a relatively high proportion of selfish investors and a sufficiently low proportion of inequity averse allocators. In this equilibrium both types of investor choose to invest (I) and the selfish allocator offers $b = 0$ and the inequity averse allocator offers $b = 1/2$.

Now, all types of parents have positive levels of cultural intolerance and consequently, they

will have incentives for active socialization. For example, a selfish investor parent expects that when his child turns out to be selfish will obtain an expected payoff of $(1 - y)/2$ and when his child turns out to be inequity averse will obtain this same expected payoff from the inequity averse allocators but, as he will punish a selfish allocator, he will incur an expected cost of $yz\lambda^*$. This latter amount is the level of cultural intolerance of the selfish parent.

In this region, given the equilibrium payoffs, we can check that the levels of cultural intolerance in each group depend on the preference distribution of the other group and are positive in the QCE region, i.e. $\Delta V_1^i(y) > 0$ and $\Delta V_2^i(x) \geq 0$ for $i = e, a$. Therefore, the optimal socialization effort functions, τ_j^i , depend on both preferences distribution (x, y) .

We state formally these results in the following lemma.

For any (x, y) such that $x \geq \widehat{x}$ and $y < y'' = \frac{1}{(1+2(z\lambda^*(1+\alpha)+\alpha(1-\lambda^*))}$ (i.e in the QCE region), then $\Delta V_j^i(y_{-j}) > 0, \forall i, \forall j$. Therefore τ_j^i is positive and depends on x and $y, \forall i, \forall j$.

Proof. See the Appendix. □

Once we have computed τ_j^{e*} and τ_j^{a*} , we equate them to obtain the demarcation curve, that is, the locus of pairs (x, y) such that the distribution of preferences in a group population remains constant over time. The demarcation curve in which the distribution of preferences in the investors population remains constant over time is given by $x' = \frac{z}{\alpha(1-z)}$, and it is independent of y_t . If $x' > x_t$ then $\tau_{1t}^e > \tau_{1t}^a$ and $\frac{\partial x_t}{\partial t} > 0$.

We can apply the same procedure to analyze the socialization decision of the allocators parents. The demarcation curve in which the distribution of preferences in the allocators population remains constant over time is given by the following equation: $y_t(x_t) = \frac{1/2-(1-x_t)\lambda^*}{\beta(1-\lambda^*(1-x_t)(1-z))}$. As it can be checked this expression is increasing in x_t .

Given a particular value of the preferences distribution in the population of investors x_t , if $y_t(x_t) > y_t$ then $\tau_{2t}^e > \tau_{2t}^a$ and $\frac{\partial y_t}{\partial t} > 0$.

In Figure 4.2, we represent the phase diagram of this nonlinear difference equation system in two variables. As we know the directional arrows indicate the intertemporal movement of

4.5. THE SOCIALIZATION PROCESS AND THE EDUCATION EFFORT BY PARENTS IN A SEGMENTED SOCIETY.

Figure 4.2.: Phase diagram in QCE region.

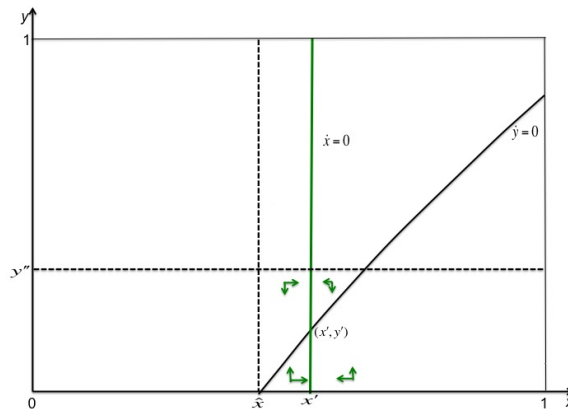

x_t and y_t .

The qualitative phase diagram analysis yields that there is a stable steady state or node of the dynamical system in the intersection of both demarcation curves: $x' = \frac{z}{\alpha(1-z)}$ and $y' = \frac{1/2 - (\frac{\alpha(1-z)-z}{\alpha(1-z)})\lambda^*}{\beta(1 - \frac{\lambda^*(\alpha(1-z)-z)}{\alpha})}$.

(x', y') is the unique stable steady-state in the QCE region.

Once again the steady state (x', y') only exists if $x' > \widehat{x}$ and $y' < y''$. In the case that one or both of these conditions do not hold, the dynamics will lead to the FCE region or, alternatively, to the ISE region as we will analyze in the next section.

LEVELS OF CULTURAL INTOLERANCE IN THE ISE REGION.

Now we will run the analysis for this case where the ISE equilibrium exists, that is, where $y \geq y''$ and $x > \widehat{x}$, and thus, the proportion of selfish allocators is relatively high. In this equilibrium the selfish investor chooses to invest (I) and the inequity averse investor chooses not to invest (N). The selfish allocator offers $b = 0$ and the inequity averse allocator offers $b = 1/2$.

In this case, all types of parents have strictly positive levels of cultural intolerance and consequently, they will have incentives for active socialization. For example, in this region, a selfish investor parent expects that when his child turns out to be selfish will obtain an expected payoff of $(1 - y)/2$ and when his child turns out to be inequity averse will obtain

a payoff of zero. Therefore, the selfish parent has a positive level of cultural intolerance which depends on $(1 - y)$, the proportion of inequity averse allocators, and on 1 , the gains from cooperation. The precise calculation of all these levels of cultural intolerance and the optimal education effort functions for both types of investors is relegated to the Appendix.

We can check that, given the equilibrium payoffs of this region, the levels of cultural intolerance in each group depend on the preference distribution of the other group and are strictly positive in the ISE region, i.e. $\Delta V_1^i(y) > 0$ and $\Delta V_2^i(x) > 0$ for $i = e, a$. Therefore, the optimal socialization effort functions, τ_j^i , depend on both preferences distribution (x, y) .

We state formally these results in the following lemma.

For any (x, y) such that $x > \widehat{x}$ and $y \geq y'' = \frac{1}{(1+2(z\lambda^*(1+\alpha)+\alpha(1-\lambda^*))}$ (i.e in the ISE region), then $\Delta V_j^i(y_{-j}) > 0, \forall i, \forall j$. Therefore τ_j^i is positive and depends on x and $y, \forall i, \forall j$.

Proof. See the Appendix. □

We equate τ_{1t}^e to τ_{1t}^a to obtain the demarcation curve in which the distribution of preferences in the investors population remains constant over time which, as it can be observed, depends on y . This equation is $x_t(y_t) = \frac{1-y_t}{2\alpha y_t}$. This expression is decreasing with y_t . Another usual way of expressing this demarcation curve is to write $\dot{x}(y) = 0$.

Given a particular value of the preferences distribution in the allocators population y_t , if $x_t(y_t) > x_t$ then $\tau_{1t}^e > \tau_{1t}^a$ and $\frac{\partial x_t}{\partial t} > 0$.

We also obtain, in the same way, the demarcation curve in which the distribution of preferences in the allocators population remains constant over time, which as it can be observed does not depend on x_t . This equation is $\bar{y} = \frac{1}{2\beta}$. Another way of expressing this demarcation curve is to write $\dot{y} = 0$.

If $\bar{y} > y_t$ then $\tau_{2t}^e > \tau_{2t}^a$ and $\frac{\partial y_t}{\partial t} > 0$.

In Figure 4.3, we represent the phase diagram of this nonlinear difference equation system in two variables. The directional arrows indicate the intertemporal movement of x_t and y_t .

The qualitative phase diagram analysis yields that there is a stable steady state or node of

Figure 4.3.: Phase diagram in ISE region.

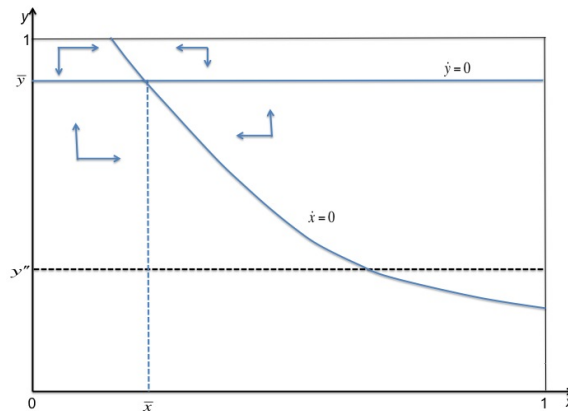

the dynamical system in the intersection of both demarcation curves: $\bar{x} = \frac{\beta-1/2}{\alpha}$ and $\bar{y} = \frac{1}{2\beta}$.

(\bar{x}, \bar{y}) is the unique stable steady-state in the ISE region .

To supplement this phase diagram analysis we make in the Appendix a local stability analysis of this fixed point.

Recall that the steady state (\bar{x}, \bar{y}) only exists if $\bar{x} > \hat{x}$. Notice that when $\bar{x} \leq \hat{x}$ the dynamics will lead to FCE region, where the FCE equilibrium is played. This latter situation is more likely for high values of the investors' power λ^* and reasonable values, from the experimental point of view, of the parameter α (the degree of disadvantageous inequity aversion), namely, $\alpha > 1$.

4.6. CULTURES IN THE LONG RUN.

We adhere to the notion of a culture, used by Rob and Zemsky (2002), as a stable, or self-reproducing pattern of behavior in a group (or a society). Therefore, we identify it as a stable steady state of the preferences dynamics.

A Culture is any stable steady state of the cultural dynamics where the same Perfect bayesian Equilibrium of the extended trust game with punishment is played.

Following the above definition, we denote as a Fully Cooperative Culture (*FCC*), any stable steady state of the cultural dynamics where a Fully Cooperative Equilibrium is played.

Similarly, Quasi Cooperative Culture (QCC) and Inefficient Separating Culture (ISC) are defined. It will be shown that our model yields one or more of the above different long run outcomes, cultures, depending basically on the values that characterize the punishment institutions, λ^* and z and on the parameters α, β of inequity-aversion agents. Furthermore, there are some cases in which, the initial distribution of preferences together with the dynamics will determine the final preserved culture. In this section we characterize the basin of attraction of the different steady states of the dynamics.

4.6.1. FULLY COOPERATIVE CULTURE

We denote as e^{p1} any stable state of the preference dynamics where the Perfect Bayesian Equilibrium (PBE) is played. Notice that in any e^{p1} steady state it is true that the proportion of selfish people has to be smaller or equal to a critical value \hat{x} . Therefore, e^{p1} exist as soon as $\hat{x} > 0$ which is true only when the punishment capacity is high enough, $\lambda^* > \frac{1}{2}$. An e^{p1} steady state always results in the most efficient outcome. Both types of investor make the specific investment while both types of allocators return half of their total surplus $b = \frac{1}{2}$ to the investors, without giving rise to any punishment possibility. In such culture all agents end the game with the highest payoff and the society achieves the most efficient outcome.

We now state the propositions which assure an e^{p1} stable state. Proposition 1 refers to the conclusion of the lemma stated in the previous section:

Proposition 1: *Any initial pair of distributions (x_0, y_0) in regions 1 and 2 is an e^{p1} steady state.*

As it has proven, there is no any incentive for both types to socialize their offsprings and each of the two populations remains locked in the initial distribution of preferences. The role of punishment capacity in this culture is vital. The higher the λ^* is, the higher the \hat{x} and the larger region 1, 2. This proposition also means that for λ^* high enough there is a significant fraction of inequity averse investors whom credible threat of punishment forces both types of allocators to return half of the total surplus ($b = \frac{1}{2}$).

Apart from region 1 and 2, the e^{p1} steady state will attract other populations that initially are placed in region 3 or 4. We start analyzing the case when the initial population starts from region 3.

Proposition 2: Assume that $\bar{x} \leq \hat{x}$, then for any (x_0, y_0) in region 3 the dynamics converges to an e^{p1} steady state with $x = \hat{x}$ and $y > y''$. (see graphic 7.1a)

Graphically, this proposition is true only if (\bar{x}, \bar{y}) is placed in region 1. In this case $\bar{x} \leq \hat{x}$ which is true for high λ^* and α . The proof of this proposition follows from the qualitative analysis of the phase diagram represented in figure 4.4. Blue arrows correspond to the dynamics converging to e^{p2} steady state of the point (\bar{x}, \bar{y}) while the green ones to e^{sep} steady state of the point (x', y') . Recall that regions 1, 2 are placed to the left of \hat{x} . Once a population cross this line, the e^{p1} is played.

Notice that for (x_0, y_0) in region 3 where $x_0 > \hat{x}$ and $y_0 > y''$ the economy initially coordinates in the inefficient separating equilibrium e^{sep} where only selfish investors invest. However, in this region the incentives for socializing an investor into inequity averse preferences are greater than into selfish preferences (i.e. $\tau_1^a > \tau_1^e$). As a consequence the proportion of selfish investors will decreased over time and at some point x will reach \hat{x} . From there on everybody plays e^{p1} .

Figure 4.4.: Phase diagram for Proposition 2

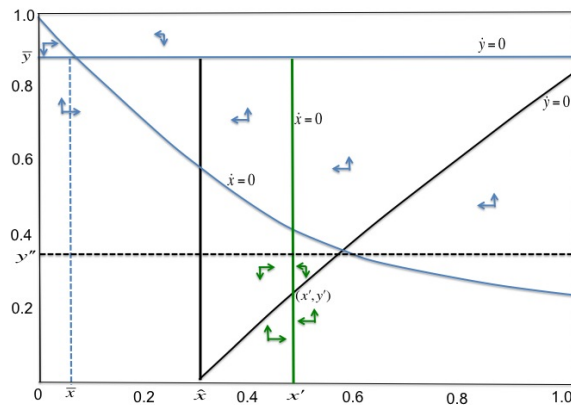

Now, we turn our interest to the case when the distribution of preferences is such that the

population departs from any point of region 4 but again the dynamics converges to an e^{p1} steady state. The relation between \bar{x} and \hat{x} defines two different propositions.

Proposition 3: Assume that $\leq \hat{x}$ then,

- a) If $x' \leq \hat{x}$, then for any (x_0, y_0) in region 4 and on the left of $\dot{y} = 0$ the dynamics converges to an e^{p1} steady state with $x = \hat{x}$ and $y < y''$. (see graphic 4.5)
- b) If $x' \leq \hat{x}$, then for any (x_0, y_0) in region 4 and on the right of $\dot{y} = 0$ the dynamics converges to an e^{p1} steady state with $x = \hat{x}$ and $y > y''$. (see graphic 4.6)
- c) If $x' \geq \hat{x}$, then for any (x_0, y_0) in region 4 the dynamics converges to an e^{p1} steady state with $x = \hat{x}$ and $y > y''$. (see graphic 4.6)

Figure 4.5.: Phase diagram for Proposition 3a and 3b

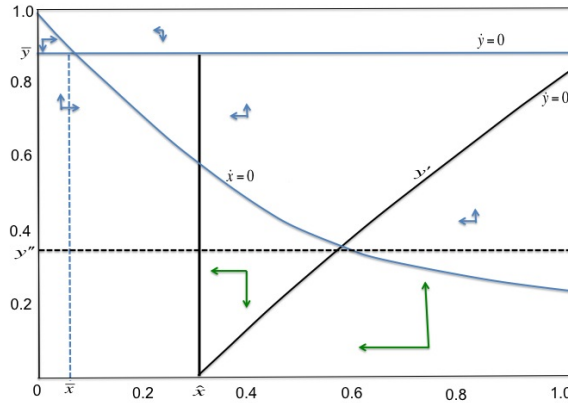

As before, the proofs of the above propositions follow of the qualitative analysis of the phase diagrams 4.5 and 4.6. In both cases, for (x_0, y_0) in region 4 with relatively high proportion of selfish investors and relatively low proportion of selfish allocators, agents initially expect to play e^{p2} . In the case where $x' \leq \hat{x}$, the incentives for socializing an investor into inequity averse preferences are greater than into selfish preferences (i.e. $\tau_1^a > \tau_1^e$). As a consequence the proportion of selfish investors, placed both in region 4 and on the left of $\dot{y} = 0$, will decreased over time and at some point x will reach \hat{x} under y'' . From there on everybody plays e^{p1} .

4.6. CULTURES IN THE LONG RUN.

Moreover, for the proportion of selfish investors, placed in region 4 but on the right of $\dot{y} = 0$, it is also true that the incentives for socializing an allocator into selfish preferences are greater than into inequity averse preferences (i.e. $\tau_2^e > \tau_2^a$). As a consequence the proportion of selfish allocators will increase over time and at some point, y will reach y'' which means that region 3 has been reached. In region 3, given that $x \leq \hat{x}$, the dynamics converges to an e^{p1} steady state with $x = \hat{x}$ and $y > y''$, exactly like in proposition 2.

In figure 4.5, the incentives for socializing an allocator into selfish preferences are greater than into inequity averse preferences (i.e. $\tau_2^e > \tau_2^a$). Just like in the case explained above, the dynamics will drive agents to e^{p1} steady state with $x = \hat{x}$ and $y > y''$, through region 3.

Figure 4.6.: Phase diagram for Proposition 3c

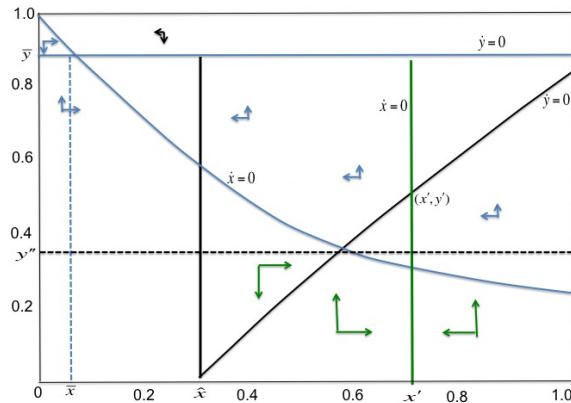

Finally, there is only one case where the population starting from region 4 will end up to e^{p1} steady state although $x' < \hat{x}$. Proposition 4 concludes:

Proposition 4: *Assume that $\bar{x} \geq \hat{x}$ but $x' < \hat{x}$, then for any (x_0, y_0) in region 4 and on the left of $\dot{y} = 0$, the dynamics converges to an e^{p1} steady state with $x = \hat{x}$ and $y < y''$. (see figure 4.7)*

The proof of proposition 4 follows the same reasoning as in proposition 3a. Because of the fact that $\tau_1^a > \tau_1^e$ the proportion of selfish investors, placed both in region 4 and on the left of $\dot{y} = 0$, will decreased over time and at some point x will reach \hat{x} under y'' . From there on everybody plays e^{p1} . Nevertheless, on the right of $\dot{y} = 0$ the situation is different, as the

economy will converge to e^{sep} . In the next section all cases driving to e^{sep} are analyzed.

Figure 4.7.: Phase diagram for Proposition 4 and 5a

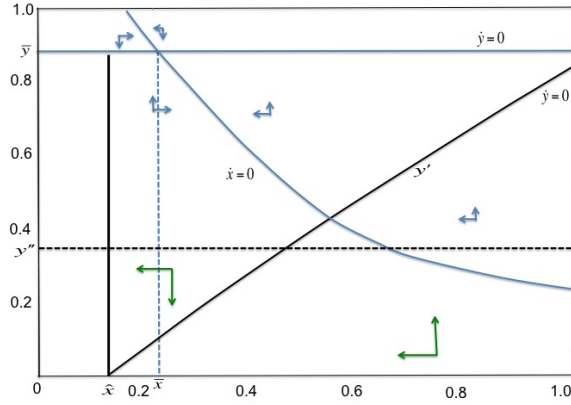

4.6.2. INEFFICIENT SEPARATE CULTURE

Under some configuration of the parameters and initial conditions of the dynamics the inefficient e^{sep} is a stable steady state, where only selfish investors proceed on investment and only inequity averse allocators return a high proportion of their total surplus ($b = \frac{1}{2}$). Moreover in this case inequity averse investors do not invest and consequently their punishment threaten and action does not make any sense.

Proposition 5: Assume that $\bar{x} \geq \hat{x}$

- and $x' < \hat{x}$, then for any (x_0, y_0) in region 4 and on the right of $\dot{y} = 0$, the dynamics converges to the preference distribution (\bar{x}, \bar{y}) where the e^{sep} is played. (see figure 4.7)
- and $x' > \bar{x}$, then for any initial condition (x_0, y_0) in region 3 or 4 the dynamics converges to the preference distribution $\bar{x} = (\beta - 0.5)/\alpha$ and $\bar{y} = 1/2\beta$ (see figure 4.8)
- and $\bar{x} > x' > \hat{x}$ then, if $y' > y''$ then for any (x_0, y_0) in region 4 the dynamics converges to the preference distribution (\bar{x}, \bar{y}) where the e^{sep} is played. (see figure 4.9)

The proof of proposition 5a follows the same reasoning as in proposition 3b. Because of the fact that $\tau_2^e > \tau_2^a$ the proportion of selfish allocators will increase over time and at some

point, y will reach y'' which means that region 3 has been reached. The difference in this situation is that because of $\bar{x} > \hat{x}$ the dynamics in region 3 converges to an e^{sep} steady state.

Figure 4.8.: Phase diagram for Proposition 5b

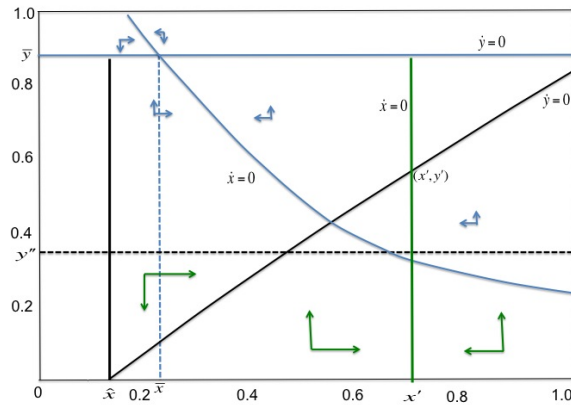

As far as it regards proposition 5b, the proof follows the same reasoning as 3c. If the population is initially allocated in region 4 and $\tau_2^e > \tau_2^a$, the proportion of selfish allocators will increase over time and at some point, y will reach y'' which means that region 3 has been reached. As $\bar{x} > \hat{x}$ the dynamics in region 3 converges to an e^{sep} steady state. This process immediate when agents are initially placed in a point within region 3.

Figure 4.9.: Phase diagram for Proposition 5c

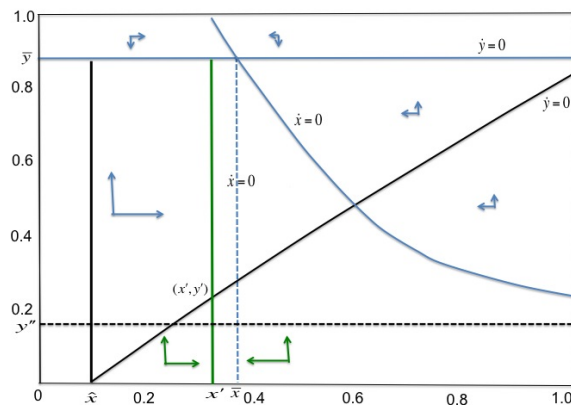

Finally, in proposition 5b where $\bar{x} > x' > \hat{x}$ and $y' > y''$, the dynamics in region 4 converges to region 3 as $\tau_2^e > \tau_2^a$. Like before, in region 3 e^{sep} is a stable steady state.

However, when $y' \leq y''$, we see in the next section that the dynamics converges to the Quasi Cooperative Culture.

4.6.3. QUASI COOPERATIVE CULTURE

Finally there is a third possible *culture* which emerges under very specific circumstances. In this culture the e^{p2} equilibrium is played where all type of investors invest but selfish allocators maximize by returning nothing to investors. In this case inequity averse investors realize their threaten of punishing allocators by destroying the maximum permitted proportion of the latter's total surplus. Compared to *ISC* the outcome is more efficient as efficient investment is realized. Nevertheless, the destruction of surplus by inequity averse investors collapses equilibrium from Fully Cooperative to Quasi Cooperative.

Proposition 6: *Assume that $x' > \hat{x}$ and $y' < y''$, then for any (x_0, y_0) ⁹, in region 4 the dynamics converges to the preference distribution (x', y') , where the e^{p2} equilibrium is played. (see figure 7.1a)*

The e^{p2} equilibrium is a stable steady state under very specific values of the parameters which set the economy initially to a preference distribution with many selfish investors and many inequity averse allocators. Only under these conditions, the economy starts and remains stuck in region 4, while there is no case where the economy departing from any other region 1, 2 or 3, converges to region 4. Nevertheless, as we will see in the next section, when λ^* is determined endogenously, there is a case where an economy, departing from region 3, converges to region 4.

⁹Note that (x_0, y_0) has to be sufficiently close to (x', y') in order for the former to be attracted by the latter. For instance, for $x_0 \rightarrow 1$ and $y_0 \rightarrow y''$ it is certain that the dynamics which converges towards e^{p1} will lead (x_0, y_0) first to region 3 and finally to region 1. We do not analyze such case for facilitating our analysis.

4.7. RE-CONSIDERING PROPOSITIONS WHEN λ^* IS ENDOGENOUSLY DETERMINED.

In the following analysis we are trying to shed light to the effect of the λ^* endogenization on the steady states of the economy. To do so we add an extra stage into our model in which, the adult agents, in the beginning of period 2, vote for their preferred λ^* . Moreover, at that time, the preference distributions of both populations are known to all agents before voting. After the outcome of the election is publicly announced and imposed, agents play the TGP and they decide for the education effort devoted to their offsprings. Finally another important assumption regarding the voting procedure is that agents are short-sighted. They can anticipate the behavior, actions and, most importantly, the effect of the dynamics of preferences only for their own and their children generation.

Compared to the model with exogenous λ^* , the main difference now is that in some cases agents can switch from one equilibrium to another by voting for a different λ^* . It is therefore useful to order agents' preferences on equilibria by calculating the corresponded utilities in each equilibrium.

- Reciprocal investor always prefer e^{p1} to e^{p2} and e^{p2} to e^{sep} . A fortiori e^{p1} is also preferred to e^{sep} (i.e. $U_{IR}^{e^{p1}} = 1/2 > \frac{1-y}{2} - \gamma y = U_{IR}^{e^{p2}} > 0 = U_{IR}^{e^{sep}}$)
- Selfish investor always prefer e^{p1} while he/she is indifferent between e^{p2} and e^{sep} (i.e. $U_{IS}^{e^{p1}} = \frac{1}{2} > \frac{1-y}{2} = U_{IS}^{e^{p2}} = U_{IS}^{e^{sep}}$).
- Reciprocal allocator is indifferent between e^{p1} and e^{p2} which are both preferred to e^{sep} (i.e. $U_{AR}^{e^{p1}} = U_{AR}^{e^{p2}} = \frac{1}{2} > \frac{x}{2} = U_{AR}^{e^{sep}}$).
- Selfish allocator always prefer e^{p2} to e^{sep} (i.e. $U_{AS}^{e^{p2}} = x + (1-x)(1-\lambda^*) > x = U_{AS}^{e^{sep}}$). e^{p1} is preferred to e^{p2} if $x < \frac{\lambda^* - 1/2}{\lambda^*} = \hat{x}$ and to e^{sep} if $x < 1/2$.

It is also very important to distinguish agents preferences over λ^* within each equilibrium. It is clear that agents, in both e^{p1} and e^{sep} , have no incentives to vote for λ^* , since λ^* is not

included in their utility functions.

However, within e^{p2} , agents have contradicting interests. In particular, selfish allocators maximize their utility with the lowest possible λ^* : $y_0'' = y_0 + \epsilon$ (which keeps them in e^{p2}). We define $\epsilon = y_0'' - y_0$ as the maximum distance “traveled” by a generation between two consecutive time-periods due to the attraction of the nearest (influential) steady state.¹⁰ Finally, reciprocal investors maximize their utility with the highest $\lambda^* = 1$, while, selfish investors and reciprocal allocators are indifferent on voting outcome since λ^* is not included in their utility functions.

Therefore, the final λ^* depends on the relative majority between selfish allocators and reciprocal investors. If reciprocal investors are the majority (i.e. $1 - x_0 > y_0$) then the voting outcome is $\lambda^* = 1$. However, if selfish allocators are the majority (i.e. $1 - x_0 < y_0$), they vote for a low enough λ^* such that $y_0'' = y_0 + \epsilon$.

Finally, when λ^* is analyzed, it has to be paid attention on its effect on the demarcation curve $y_t'(x_t)$ in region 4, on \hat{x} and on y'' . Graphically, a higher λ^* brings $y_t'(x_t)$ and \hat{x} on the right and y'' up as it is shown in figure 4.10. In particular, in this graph the case where λ_0^* switches to $\lambda_1^* = 1$ is presented. Note that when $\lambda_1^* = 1$ both $y_t'(x_t)$ and \hat{x} cut the x axes on their maximum value $x = 0.5$, no matter what are the values of the other parameters α, β and z . However, the parallel movement of y'' depends on the parameters and especially on z . The lower z is, the longer the parallel movement of y'' . When $z = 0$ then for $\lambda_1^* = 1$, $y'' = 1$.

4.7.1. RECONSIDERING PROPOSITION 1

In regions 1 and 2 the majority of agents are already enjoying the maximum utility so they vote for the initial λ_0^* . In particular, in region 1 no agent prefers to move to region 3, since all agents' utility in e^{p1} is greater than utility in e^{sep} . This is also true for selfish allocators since $x_0 < \frac{1}{2} = \max(\hat{x})$. In region 2, where agents have the opportunity to switch from e^{p1} to

¹⁰It is the minimum distance ensuring that agents and their offsprings will continue being in the region that they have chosen to be in the next period, no matter the dynamics.

4.7. RE-CONSIDERING PROPOSITIONS WHEN λ^* IS ENDOGENOUSLY DETERMINED.

Figure 4.10.: The effect of λ^* increasing on $y'_t(x_t)$, \hat{x} and y'' .

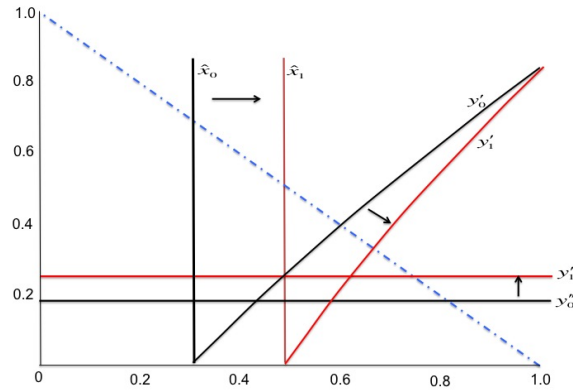

e^{p2} by voting for a sufficient low λ^* , all agents but reciprocal allocators who are indifferent, prefer e^{p1} to e^{p2} . This is even true for selfish allocators as $x < \hat{x}$. Restating proposition 1:

Proposition R_1 : Any initial pair of distributions (x_0, y_0) in regions 1 and 2 is an e^{p1} steady state, even if λ^ is endogenously determined.*

4.7.2. RECONSIDERING PROPOSITION 2

It is true that the economy will end to e^{p1} steady state with or without endogenous λ^* . However, this process can be accelerated when λ^* is endogenously determined. In the case where $x_0 \leq \frac{1}{2}$ all agents¹¹ vote for a sufficient high $\lambda^*_{e^{p1}}$ such that $\hat{x} \geq x_0$ which makes the economy to “jumb” directly to region 1.

However, as soon as $x_0 > \frac{1}{2}$, agents do not have any incentive to vote for $\lambda^*_{e^{p1}}$ since e^{p1} steady state is not feasible. Therefore, for some periods all subsequent generations will continue moving towards (\bar{x}, \bar{y}) . At some point, the generation which is born with initial condition $x_0 = \frac{1}{2} - \epsilon$, realizes that all agents will be better off, if they vote for $\lambda^*_{e^{p1}} = 1$, which directly brings them to region 1. Thus, even in this case, the dynamics converges to an e^{p1} steady state with $x = \hat{x} = \frac{1}{2}$ and $y > y''$. In this region, as explained in proposition 1, there are no socialization incentives and each of the two populations remains locked in the initial distribution of preferences. Being in region 1, no agent has incentives to change λ^* .

¹¹Given that $x_0 \leq \frac{1}{2} = \max(\hat{x})$, even selfish allocators prefer e^{p1} to e^{sep} .

Therefore, proposition 2 is restated as follows:

Proposition R_2 : Assume that $\bar{x} \leq \hat{x}$, λ^* endogenous and

- 1) $x_0 \leq \frac{1}{2}$, then for any (x_0, y_0) in region 3, the majority of agents vote for a sufficient high $\lambda_{e^{p1}}^*$: $x_0 = \hat{x}$ which elevates economy to region 1 and leads directly to an e^{p1} steady state with $x = \hat{x} \leq \frac{1}{2}$ and $y > y''$.
- 2) $x_0 > \frac{1}{2}$, then for any (x_0, y_0) in region 3 the dynamics converging initially towards (\bar{x}, \bar{y}) will drive generations to the point $x_0 = \frac{1}{2} - \epsilon$, where the majority of agents vote for $\lambda_{e^{p1}}^* = 1$ which elevates economy to region 1 and leads directly to an e^{p1} steady state with $x = \hat{x} = \frac{1}{2}$ and $y > y''$.

Henceforth, for simplification reasons, we will refer to the above e^{p1} steady state which is achieved faster because of the election of $\lambda_{e^{p1}}^* = 1$ as $e_{\lambda^*=1}^{p1}$.

In figure 4.11, we illustrate two examples corresponding to propositions $R_{2.1}$ and $R_{2.2}$. Blue arrows represent movements due to dynamics¹² while black arrows movements due to changes in λ^* . Locations are illustrated with colored points. Blue dot with (x_0, y_0) corresponds to the initial-departing location of one generation, while the red point symbolizes the final location of the generation driven either by dynamics or by changes on λ^* . Note that in some cases movement is no necessary, so red dot is not appeared at all. Finally the indicators t_1, t_2 , etc. represent the sequentiality of the events. Although in most of the cases they are also referred to different generations, this is not always true. In some case, the same generation participates in more than one sequential actions.

4.7.3. RECONSIDERING PROPOSITION 3

First of all, just like in Proposition $R_{2.2}$, when $x_0 \leq \frac{1}{2} + \epsilon$ and λ^* endogenous, no matter the relation between x' and \hat{x} , agents vote for a sufficient high λ^* which elevates economy to region 1.

¹²In this figures, we avoid illustrating the dynamics as they have already been represented in the figures of the previous section. However, the direction of blue arrow in each case implies the corresponding dynamics.

4.7. RE-CONSIDERING PROPOSITIONS WHEN λ^* IS ENDOGENOUSLY DETERMINED.

Figure 4.11.: Proposition R_2

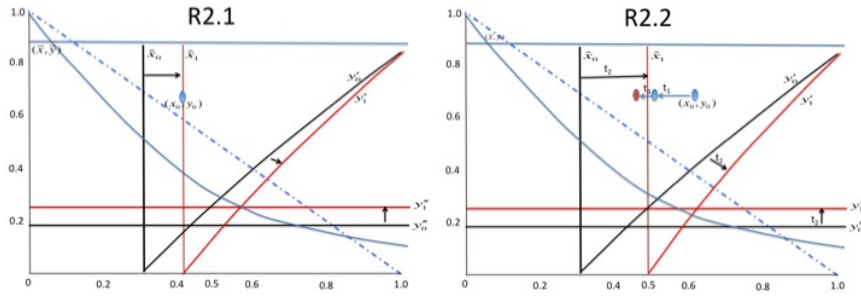

However, when $x_0 > \frac{1}{2}$, $x' \leq \hat{x}$ and agents (x_0, y_0) are placed in region 4, e^{p2} is implemented and e^{p1} is not longer feasible. Thus, the only alternative is region 3 where e^{sep} is implemented. As it was explained before, all agents but selfish investors who are indifferent, prefer e^{p2} to e^{sep} . So the majority votes for a sufficient $\lambda^* \leq 1$ such that $y'' = y_0 + \epsilon$, which keeps them in region 4 for the longest period.

Once in region 4, agents have contradicting interests regarding λ^* . If reciprocal allocators are the majority then the voting outcome is $\lambda^* = 1$. On the other hand, if selfish allocators are the majority, they vote for a low enough $\lambda^* \leq 1$ such that $y''_0 = y_0 + \epsilon$. Selfish allocators of next generations gradually vote for higher λ^* , as in each consecutive period, new generation is “born” on the limit between region 4 and 3 due to the cultural dynamics. As a result, sooner or later, selfish allocators will end up voting for $\lambda^* = 1$.

This is exactly the case illustrated in figure 4.12. Generation (x_0, y_0) who is attracted by (\bar{x}, \bar{y}) and knows that it will end up to (x_0, y_0) , votes in t_0 for λ^* such that $y''_0 = y_0 + \epsilon$. Following the same reasoning, generation (x_1, y_1) votes in t_1 for λ^* such that $y''_1 = y_1 + \epsilon$. Assuming that y''_2 is the highest possible y'' achieved only when $\lambda^* = 1$, generation (x_2, y_2) finally votes in t_2 for $\lambda^* = 1$. Moreover, it is the last generation enjoying the benefits of e^{p2} . All the consequent generation will be born above y'' and, after some periods in region 3, will end up to e^{p1} steady state.

Thus, we conclude that if $x_0 > \frac{1}{2}$, $x' \leq \hat{x}$, then for any agents (x_0, y_0) initially placed in region 4, no matter which type represents the majority, the dynamics converges to an e^{p1}

steady state with $x = \hat{x}$. More precisely, if (x_0, y_0) is on the left (right) of $\dot{y} = 0$ then the e^{p1} steady state with $x = \hat{x}$ is also under (over) y'' .

Figure 4.12.: Evolution of λ^* when selfish allocators are in the majority.

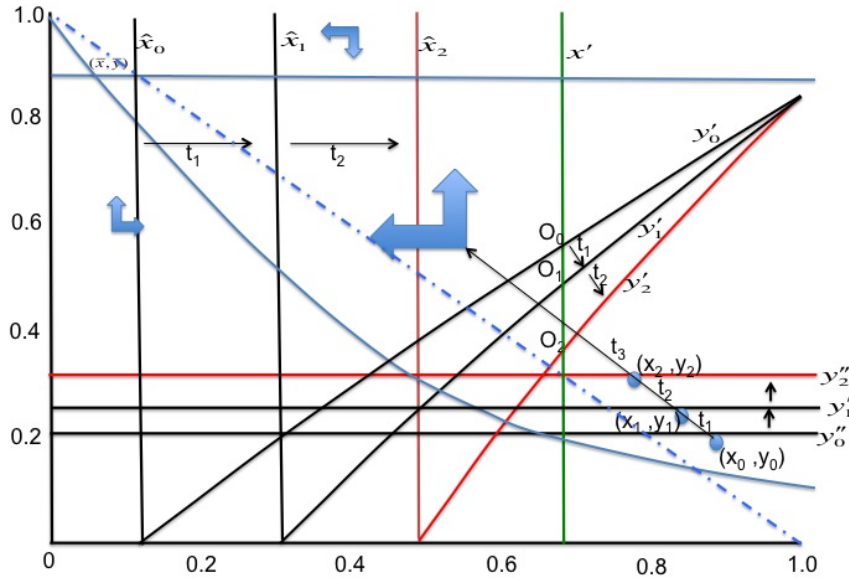

Let us now analyze the case where $x_0 > \frac{1}{2}$, $x' > \hat{x}$ and agents (x_0, y_0) are initially placed in region 4 where the e^{p2} is implemented. Once more we have two different cases depending on the preferences being in the majority. If reciprocal investors are the majority, then the voting outcome is $\lambda^* = 1$. Depending on the positions of (x_0, y_0) and x' (see figure 4.13)¹³ in relation with the intersection of y_1'' and y_1' (point A), two basic scenarios can be distinguished:

1) If x' is placed on the left of the intersection A (i.e. x'_A), then x'_A intersects y_1' *under* y_1'' . Then, for any (x_0, y_0) , sufficiently close¹⁴ to (x', y') , the dynamics converges to the preference distribution (x', y') (point O_A) where the e^{p2} equilibrium is played (see Proposition 6).

2) If, finally, (x_0, y_0) is not sufficiently close to (x', y') or x' is placed on the right of the intersection A (i.e. x'_B), so that x'_B intersects y_1' *over* y_1'' then, the dynamics converges to e^{p1} steady state with $x = \hat{x}$ and $y > y''$ (see Proposition 3b).

¹³In this figure we focus only in region 4. The dynamics in the other regions are exactly like in figure 7.1c

¹⁴As it explained later in proposition 6, in order for (x_0, y_0) to be attracted from (x', y') , the former has to be initially placed sufficiently close to the latter.

4.7. RE-CONSIDERING PROPOSITIONS WHEN λ^* IS ENDOGENOUSLY DETERMINED.

Figure 4.13.: The effect of voting $\lambda^* = 1$ when $x_0 > \frac{1}{2}$.

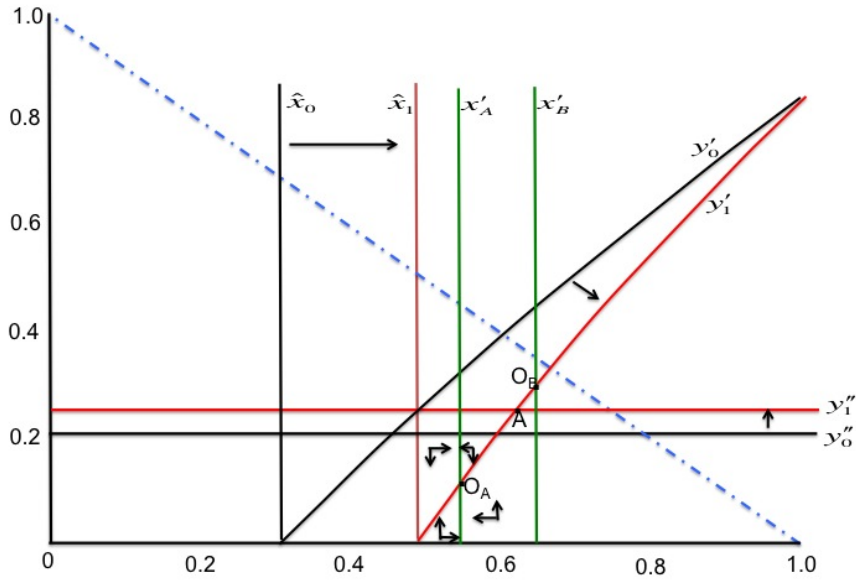

In the contrary case, when selfish allocators are the majority, they vote for a $\lambda^* \leq 1$ such that $y''_0 = y_0 + \epsilon$. Although both of the above two scenarios are possible, when $x_0 + y_0 > 1$, the closest intersection of x' with y'_1 under y''_1 will possibly be far from the initial (x_0, y_0) and therefore the dynamics is more likely to converge to e^{p1} steady state after passing through region 3. Again, selfish investors, in order to remain in region 3 for the longest time, will increase gradually λ^* up to 1. Even with $\lambda^* = 1$, the generation will, at some point, pass to region 3, ending up to $e^{p1}_{\lambda=1}$ steady state.

However, when $x_0 + y_0 > 1$ there is a unique case where the punishment capacity might not end up to its highest value ($\lambda^* \neq 1$). It is the case where the selfish agents vote for $\lambda^*_{ep2} < 1 : y_0 < y''$ and x' intersects y' under y'' . If finally the generation departing from (x_0, y_0) is also placed sufficiently close to (x', y') then the economy will converge and be stuck in an e^{p2} steady state by selecting $\lambda^*_{ep2} < 1$.

Proposition 3 is therefore restated as follows:

Proposition R_3 : Assume that $\bar{x} \leq \hat{x}$, λ^* endogenous,

ab) if $x' \leq \hat{x}$ and ,

ab.1) $x_0 \leq \frac{1}{2}$ then, for any (x_0, y_0) in region 4, the majority of agents vote for a sufficient high

$\lambda_{e^{p1}}^* : x_0 = \hat{x}$ which elevates economy to region 2 and leads directly to an e^{p1} steady state with $x = \hat{x} \leq \frac{1}{2}$ and $y < y''$.

a.2) $x_0 > \frac{1}{2}$ then, for any (x_0, y_0) in region 4 and on the left of $\dot{y} = 0$ the dynamics converges to an $e_{\lambda^*=1}^{p1}$ steady state with $x = \hat{x} = \frac{1}{2}$ and $y < y''$, no matter the preferences in the majority.

b.2) $x_0 > \frac{1}{2}$ then, for any (x_0, y_0) in region 4 and on the right of $\dot{y} = 0$ the dynamics converges to an $e_{\lambda^*=1}^{p1}$ steady state with $x = \hat{x} = \frac{1}{2}$ and $y > y''$, no matter the preferences in the majority.

c) if $x' > \hat{x}$,

c.1) and $x_0 \leq \frac{1}{2}$ then, for any (x_0, y_0) in region 4, the majority of agents vote for a sufficient high $\lambda_{e^{p1}}^* : x_0 = \hat{x}$ which elevates economy to region 2 and leads directly to an e^{p1} steady state with $x = \hat{x} \leq \frac{1}{2}$ and $y < y''$.

c.2) $x_0 > \frac{1}{2}$ and there is $\lambda_{e^{p2}}^* = 1$, elected by the reciprocal or $\lambda_{e^{p2}}^* : y_0 < y''$ elected by the selfish majority, which makes both y' intersecting with x' under y'' and (x_0, y_0) being sufficiently close to (x', y') then, for any (x_0, y_0) in region 4 the dynamics converges to the preference distribution (x', y') where the e^{p2} equilibrium is played.

c.3) $x_0 > \frac{1}{2}$ and there is $\lambda_{e^{p2}}^* = 1$, elected by the reciprocal or $\lambda_{e^{p2}}^* : y_0 < y''$ elected by the selfish majority, which makes y' intersecting with x' over y'' or sufficiently far from (x_0, y_0) then, for any (x_0, y_0) in region 4 the dynamics converges to an $e_{\lambda^*=1}^{p1}$ steady state with $x = \hat{x} = \frac{1}{2}$ and $y > y'$

Following the symbolism of previous illustrations, in figure 4.14, we present six examples corresponding to the six different propositions described above.

4.7. RE-CONSIDERING PROPOSITIONS WHEN λ^* IS ENDOGENOUSLY DETERMINED.

Figure 4.14.: Proposition R_3

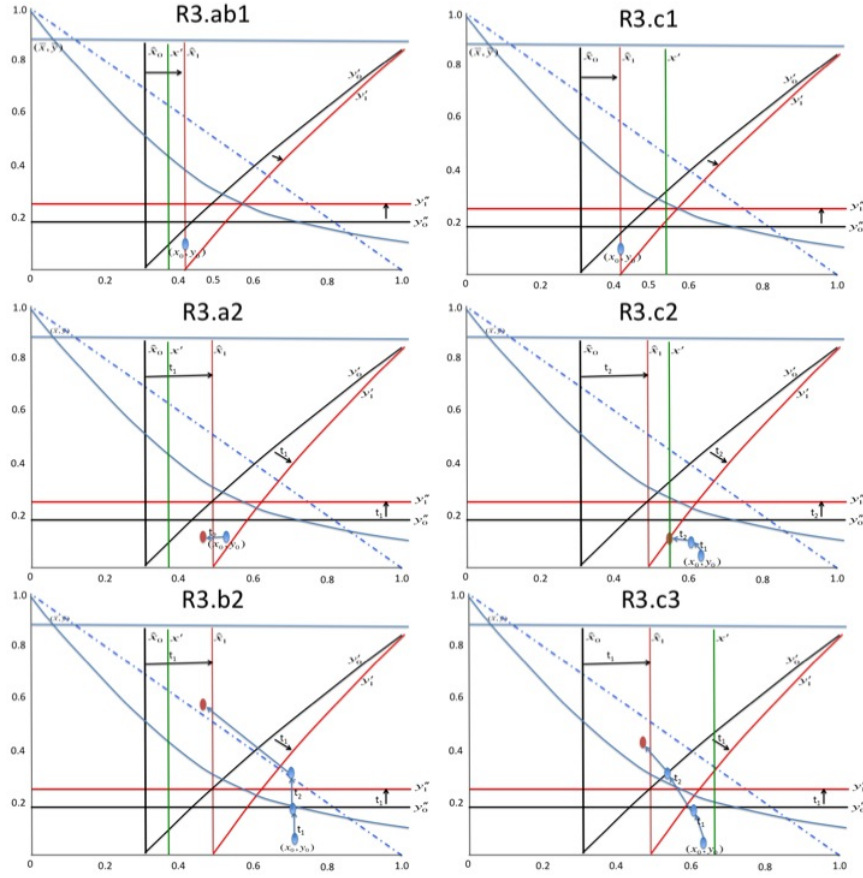

4.7.4. RECONSIDERING PROPOSITION 4

The analysis of this case follows the reasoning of Proposition R_3a . However, for $\alpha \geq \beta$ and $1 > \beta \geq 0.5$, it is always true that $\bar{x} < \frac{1}{2}$. Given that the majority of agents, in their attempt to avoid passing from e^{p2} to e^{sep} , have already vote for $\lambda_{e^{p2}}^* = 1$ and therefore $\hat{x} \geq \bar{x}$. In other words, e^{sep} is no longer a steady state since with endogenous λ^* , (\bar{x}, \bar{y}) is always incorporated in region 1.

Proposition 4 is therefore restated as follows:

Proposition R_4 : Assume that $\bar{x} \geq \hat{x}$, $x' < \hat{x}$, λ^* endogenous and

- 1) $x_0 \leq \frac{1}{2}$ then, for any (x_0, y_0) in region 4, the majority of agents vote for a sufficient high $\lambda_{e^{p1}}^* : x_0 = \hat{x}$ which elevates economy to region 2 and leads directly to an e^{p1} steady

Figure 4.15.: Proposition R_4 .

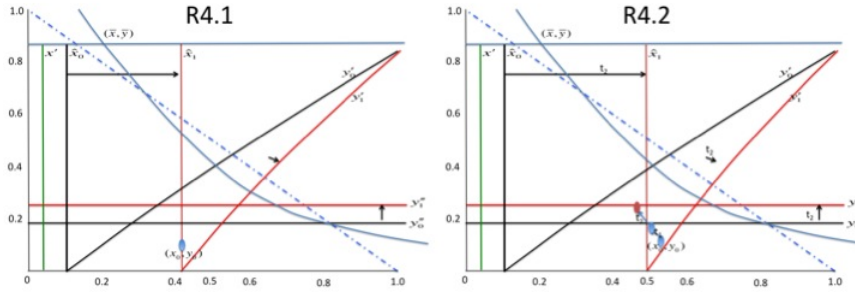

state with $x = \hat{x} \leq \frac{1}{2}$ and $y > y''$.

- 2) $x_0 > \frac{1}{2}$ then, for any (x_0, y_0) in region 4 on the left of $\dot{y} = 0$, the dynamics converges to an $e_{\lambda^*=1}^{p1}$ steady state with $x = \hat{x} = \frac{1}{2}$ and $y < y''$.

Figure 4.15 illustrates two examples corresponding to the proposals described above.

4.7.5. RECONSIDERING PROPOSITION 5

As all previous cases where (x_0, y_0) is in region 3 (or 4) and $x_0 < \frac{1}{2} + \epsilon$, agents will vote directly for $\lambda_{e^{p1}}^*$, ending up in an e^{p1} steady state with $x = \hat{x} = \frac{1}{2}$.

Moreover, under very specific conditions, agents, who are initially placed in region 3 but very close to region 4 ($y \rightarrow y''$), will vote for $\lambda_{e^{p2}}^*$, which may also lead to e^{p2} steady state. This is actually the case of the proposition R_3b2 where reciprocal majority votes for $\lambda_{e^{p2}}^* = 1$ which creates a stable e^{p2} .

Finally, even the agents satisfying R_3b3 will initially move towards e^{p2} steady state, but inevitably, they will also end up to e^{p1} steady state. Restating Proposition 5:

Proposition R_5 : Assume that $\bar{x} \geq \hat{x}$, λ^* endogenous

- 1) $x_0 \leq \frac{1}{2}$ then, for any (x_0, y_0) in region 3, the majority of agents vote for a sufficient high $\lambda_{e^{p1}}^* : x_0 = \hat{x}$ which elevates economy to region 1 and leads directly to an e^{p1} steady state with $x = \hat{x} \leq \frac{1}{2}$ and $y > y''$.

4.7. RE-CONSIDERING PROPOSITIONS WHEN λ^* IS ENDOGENOUSLY DETERMINED.

Figure 4.16.: Proposition R_5

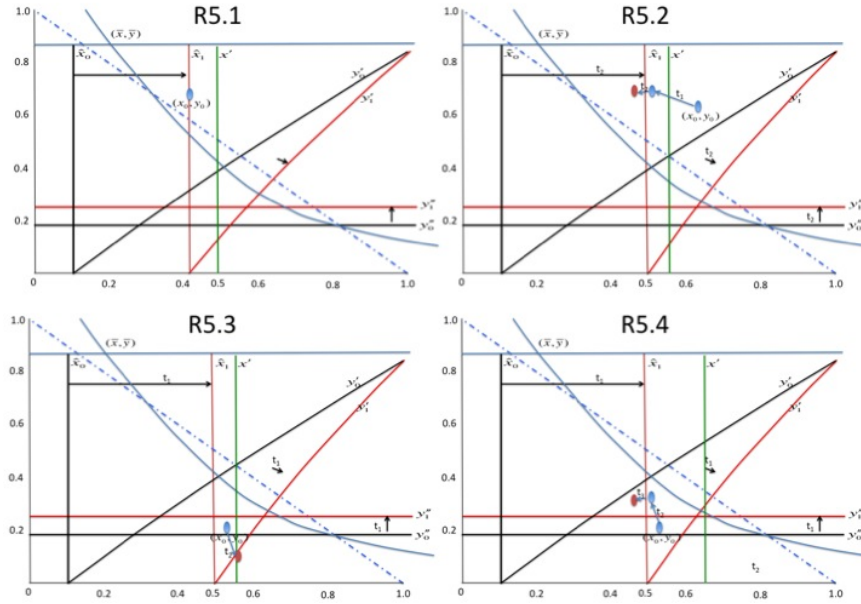

- 2) $x_0 > \frac{1}{2}$ and there is no $\lambda_{ep2}^* \leq 1 : y_0 < y''$ then, for any (x_0, y_0) in region 3, the dynamics converging initially towards (\bar{x}, \bar{y}) will drive generations to the point $x_0 = \frac{1}{2} - \epsilon$, where the majority of agents vote for a $\lambda_{ep1}^* = 1$ which elevates economy to region 1 and leads directly to an $e_{\lambda^*=1}^{p1}$ steady state with $x = \hat{x} = \frac{1}{2}$ and $y > y''$.
- 3) $x_0 > \frac{1}{2}$ and there is $\lambda_{ep2}^* = 1 : y_0 < y''$, elected by the reciprocal majority, which makes both y' intersecting with x' under y'' and (x_0, y_0) being sufficiently close to (x', y') then, for any (x_0, y_0) in region 3 the dynamics converges to the preference distribution (x', y') where the e^{p2} equilibrium is played.
- 4) $x_0 > \frac{1}{2}$ and there is sufficiently high $\lambda_{ep2}^* \leq 1 : y_0 < y''$, elected either instantly by the reciprocal or gradually by the selfish majority, which makes y' intersecting with x' over y'' or/and (x_0, y_0) being sufficiently far from (x', y') then, for any (x_0, y_0) in region 3 the dynamics converges to an $e_{\lambda^*=1}^{p1}$ steady state with $x = \hat{x} = \frac{1}{2}$ and $y > y''$.

Figure 4.16 illustrates four examples corresponding to the proposals described above. Notice that $R_{5.3}$ and $R_{5.4}$ are the only cases in which a generation departing from an ISE region moves towards an QCE region, where e^{p2} will be played either permanently

($R_{5.3}$) or temporarily ($R_{5.4}$).

4.7.6. RECONSIDERING PROPOSITION 6

Following previous analysis proposition 6 is restating as follows:

Proposition R_6 : Assume that $x' > \hat{x}$, $y' < y''$, λ^ endogenous*

- 1) and $x_0 \leq \frac{1}{2}$ then, for any (x_0, y_0) in region 4, the majority of agents vote for a sufficient high λ_{ep1}^* : $x_0 = \hat{x} \leq \frac{1}{2}$ which elevates economy to region 2 and leads directly to an e^{p1} steady state with $x = \hat{x}$ and $y < y''$.
- 2) and $x_0 > \frac{1}{2}$ then, for any (x_0, y_0) sufficiently close to (x', y') in region 4 the dynamics converges to the preference distribution (x', y') , where the e^{p2} equilibrium is played.

Figure 4.17 illustrates two examples corresponding to the proposals described above.

Figure 4.17.: Proposition R_6

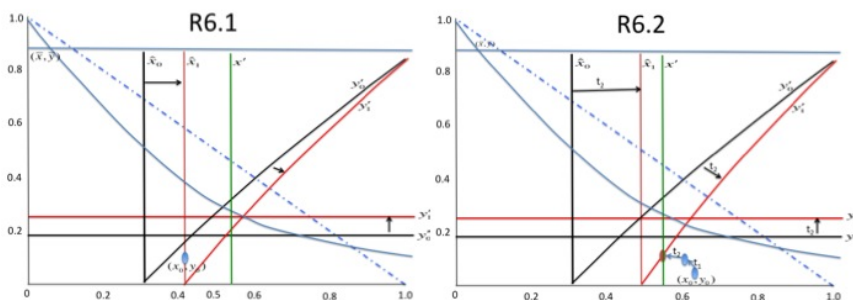

We summarize this section in four conclusive results. First of all, if the initial preference distribution of the two populations defines that the majority of investors is fair-minded ($x_0 \leq \frac{1}{2}$) then a sufficient high elected λ_{ep1}^* brings the economy *immediately* to a *culture* where an e^{p1} steady state is played. Second, there is no any more possibility for an e^{sep} steady state. Generations will either end up to an e^{p1} or to an e^{p2} . Third, a generation which is stuck or converges to an e^{p2} steady state under the condition of the exogenous λ^* , it can now escape from this trap only if the majority of investors is fair-minded ($x_0 \leq \frac{1}{2}$) and it therefore votes

4.8. CONCLUSION

for a sufficient high $\lambda_{e^{p1}}^*$. However, if the majority is selfish ($x_0 > \frac{1}{2}$) the economy will remain to an e^{p2} steady state. Fourth, under very specific conditions, there is a case that a generation, initially converging to a Fully Cooperative Equilibrium, is finally trapped to a Quasi Cooperative Equilibrium as a result of the myopic behavior of the agents. In their attempt to avoid the Insufficient Separate Equilibrium agents vote for a high $\lambda_{e^{p2}}^*$ which binds them to an e^{p2} steady state.

4.8. CONCLUSION

In the present study we have shown the importance of the punishment institutions in the achievement of trust and efficient outcomes. Different levels of the two main determinants of the institutions, namely punishment cost and capacity, have been proved to have a significant impact in cooperation. As it has also been shown in previous, especially experimental, studies, the low of demand is applied in the relation between efficient punishment (representing quantity) and its cost (representing price). The higher the cost is the lower the punishment and therefore the cooperation in the society.

The primary focus and the contribution of this study (based on the results of Olcina and Calabuig, 2008(113)) is the importance of punishment capacity on the efficient outcomes. Punishment capacity could take many interpretations depending on the applied framework. In labor markets corresponds to the retaliatory power of labor unions, in international markets could be seen as the sanctioning mechanism or threat of the international trade organizations or finally in a society's legal system could represent the effectiveness of the laws and the corresponding beliefs of citizens over the "parity of treatment". In all aforementioned cases, though, the notion of punishment capacity is strictly and positively related to the credibility of investors' threaten over punishment.

In our analysis, we have shown that it is not only the punishment capacity and cost that assures the efficient outcome. It is also necessary the "efficient" composition of the society, consisting of a sufficient number of fair-minded agents who are willing to realize their

punishment threaten when defected actions are taken by the self regarded agents. A Fully Cooperative Culture is then achieved with the satisfaction of the above conditions either spontaneously or after a dynamic convergence of the preferences of different generations through time.

Finally, in this study we have analyzed the effect of an endogenously determined punishment capacity with the use of a simple majority voting mechanism. We have seen that voting accelerates the convergence to Fully Cooperative Cultures as a sufficient high elected λ^* shorten the path leading to this culture. Moreover, the possibility of the economy to converge to an Inefficient Separate Culture is totally disappeared as all possible initial preference distributions end either to a Fully or to a Quasi Cooperative Cultures. The social implication of this result is that no matter the initial preference composition of the society, the “democratization” leads the economy in the election of a high (in most of the cases total) punishment capacity which assures efficient outcomes. This result will be valid as long as the punishment capacity supports the beliefs of agents on the ability of the society to implement fairly punishment. Only in this case, the punishment capacity is real and therefore the threaten of fair-minded agents is credible and effective.

PART III.

GENERAL CONCLUSION

CONCLUSION

In this thesis I attempt to show how Biological, Economic and Cultural heritage are inter-related with each other and in what extent they affect agents' preferences and economic decisions. The intention was not an exhaustive analysis of every biological and economic characteristics. Rather, I consider the first two essays of my thesis as an representative and descriptive approach regarding these two aspects. In addition, they introduced me to the world of behavioral and experimental economics and provided the groundwork for my last theoretical work. Intergenerational Cultural Transmission therefore is another part of the same puzzle which attempts to describe the intergenerational transmission of trust. I conclude this thesis with my personal view over the different methodologies applied during my work while in the last section I sketch my future plans for further research under the title: "Experiment on Intergenerational Trust Transmission".

5.1. METHODOLOGICAL APPROACHES

For the conduction of my research, I used four different methodological approaches. In particular: experiments in the field, survey methodology, lab experiments and theoretical modeling.

In the first study about obesity, we conducted a field experiment. Although the design proved to be quite demanding, finally we have left with a very rich dataset containing observations of 269 subjects. The comparative advantage of this methodology is that the researcher closely supervises the whole procedure while in the same time participants are act-

5.2. FURTHER RESEARCH: EXPERIMENTS ON INTERGENERATIONAL TRUST TRANSMISSION (EXITT)

ing in their natural environment avoiding in that way any biases steaming from the artificiality of the environment.

The second study combines two different methodologies; survey techniques and lab experiments. During the first stage participants filled in a questionnaire while in the second, they participated in an economic experiment in the laboratory. The use of the questionnaire provided the necessary information as well as the time to organize the experiment. Laboratory experiments offered a controlled environment and allowed us to observe treatment effects. Combining the two we managed to control part of the history and experience that a subject carries with him in his life. With the use of the questionnaire we first isolated the part of the real life which we were interesting in (i.e. wealth) which was finally incorporated in the controlled environment of the laboratory.

Finally, the third methodological tool used in this study is theoretical modeling. Taking into account findings from previous experimental and empirical studies, as well as own intuition we try to model important aspects of reality using truthful assumptions. A good model should be parsimonious and descriptive leading to useful conclusions that about real life.

5.2. FURTHER RESEARCH: EXPERIMENTS ON INTERGENERATIONAL TRUST TRANSMISSION (EXITT)

What follows is a short description of the study designed to experimentally test the main result of the theoretical work. It consists of an Trust Game experiment with punishment opportunities. Treatment effects include the punishment capacity, and subjectsreferences regarding distributional allocations. The experiment is designed in order to test the following hypotheses.

- Do different punishment capacity levels have an impact on the cooperative outcomes?
- Does the endogenization of punishment capacity result on more efficient outcomes?

In order to facilitate analysis, I first describe the Trust Game with Punishment applied only to one generation and then I proceed by explaining the intergenerational version.

5.2.1. ONE GENERATION GAME

We use a modified version of the well-known Trust Game by Berg et. al (1995) (91) with an additional punishment stage. Agents being always in the first group (investors) know that they are matched always with a different person of the other group (allocators). During the first stage of this two-person game, each investor is given the choice of sending half (3€) or none of his/her 6€ experimental payment to an anonymous partner, the allocator. If investor sends nothing then the game ends and both players earn 6€. If investors decides to send the 3€ then the experimenter triples the money sent to allocator and the game continues to the second and third stages.

In stage 2, allocator decides whether he/she wants to return 6€ or nothing to the investor. While the first alternative brings the two players in the end of the second stage in a fair re-allocation of their endowments (9€ to each player), the second one brings them in a rather unequal outcome (Investor 3€ and Allocator 15€). Only in the latter case, the game continues to the third stage.

In our version of Trust Game, we incorporate an additional third stage where the investor, after observing that the allocator has returned nothing, has the option to punish the latter, at some positive cost ($z=0.2$), destroying up to a proportion ($\lambda^* = 1$ or $\lambda^* = 0.4$) of the allocator payoff. In particular, each investor simultaneously decides how many punishment points to assign to the allocator who is matched with. Each punishment point costs the punisher one point and reduces the earnings of the punished subject by five points. After the punishment stage, subjects are informed of the number of punishment points assigned to them. As in Fehr and Gächter (2000) (99), subjects do not receive specific information concerning who punished whom.

5.2. FURTHER RESEARCH: EXPERIMENTS ON INTERGENERATIONAL TRUST TRANSMISSION (EXITT)

In our setting, two different 9-period, fixed-role¹ treatments are conducted, using the typical procedures of anonymity, neutrally-worded instructions, and monetary incentives. Subjects participate in only one of these two treatments, while they are explicitly instructed that their payment will be the result of only one of the 9 periods which will be randomly drawn in the end of the game.²

The difference between the two treatments is the different punishment capacity level of investors during the progress of the game. While in the first 3 periods of treatment A (TA_{1-3}) investors are allowed to destroy 0% or 40% or 100% of allocators' payoffs, during periods 4-6 (TA_{4-6}), they are allowed to destroy only 0% or 40% of allocators' payoffs. The sequence of permitted actions are exactly the opposite in treatment B. Investors in TB_{1-3} are allowed to destroy only 0% or 40% of allocators' payoffs while in TB_{4-6} the option of destroying even the 100% of allocators' payoffs, is added.³ However, in the last three periods of both treatments (TA_{7-9} and TB_{7-9}) the decision of the punishment capacity is being endogenized. Investors can destroy either 0-40% or 0-40-100% of allocators payoffs, depending on the outcome of the voting (following the majority rule), taking place in the 6th period.

In particular, in the end of period 6, subjects are asked to participate voluntarily in a costly voting. Non voters does not incur any cost, but were aware that the decision of the voters would be bidding for them for the last three periods of the game. However the cost is not so costly (0.5€). Actually, subjects are instructed that in the end of period 6, they receive an extra 0.5€ which can be devoted it only for voting. If they decide to vote this additional monetary benefit will be lost.⁴

The right of voting is assigned to all members (12) within the same treatment, irrespectively of the subjects' role up to that moment. We use a simple majority rule. The alternative gaining more votes is the winning one that it is implemented for the last three periods of the

¹Each subject maintains the same role of Investor or Allocator during the 9 periods of the game. These two roles are labeled in the instructions as Player A and Player B respectively.

²We avoid in this way any endowment effects.

³We use this design in order to be able to control for order effect when we perform the econometric analysis.

⁴We use this cost mechanism in order to avoid any endowment effects and at the same time to have comparable results among TGP played in different periods

game. In the case of ties or no-votes, the outcome is determined randomly.

In figure 5.1 the decision tree for TA_{1-3} and TB_{4-6} is presented. The only difference with TA_{4-6} and TB_{1-3} is that the decision choice D1 with 0 payoffs for both players is excluded totally from the choice set.

Figure 5.1.: TA_{1-3} and TB_{4-6} decision tree

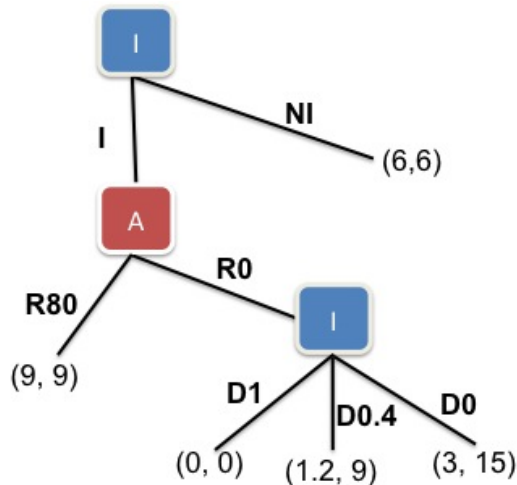

According to our setting, in each treatment, there are 12 different subjects participating, 6 in the role of allocator and 6 in the role of investor. During the first 6 periods the perfect stranger protocol is followed where subjects are never rematched. In the last 3 periods, each subject is re-matched with 3 of the subjects who has already been matched with in the previous 6 periods.⁵ Although participants have already played against each other, random rematching lessens the negative effects of a simple “repeated game”.

5.2.2. INTER-GENERATION TRUST GAME WITH PUNISHMENT

Groups of 12 subjects, 6 investors and 6 allocators are recruited into the laboratory and play the TGP for 9 rounds following the rules described above. After their participation is over each one is replaced by another agent⁶, his/her laboratory descendent, who then plays the TGP for 9 rounds with a new group of subjects. This group is then replaced by another 12

⁵Subjects are informed from the beginning for the matching mechanism.

⁶Following Calabuig and Olcina(2008) each investor is replaced by investor and each allocator by an allocator.

5.2. FURTHER RESEARCH: EXPERIMENTS ON INTERGENERATIONAL TRUST TRANSMISSION (EXITT)

successors who take their place and play on. Totally 60 persons will represent 5 different generations for each treatment.⁷

Every each 3 periods, when the experimental condition of punishment capacity changes, successors will possibly receive two messages. The first message (oblique transmission) is always revealed to all successors (in the same neighborhood) without any cost and it gives a common information about the average performance of all predecessor in all previous 3 periods. In particular, investors in generation t are informed about the percentage (out of 9 observations⁸) of investors in generation $t - 1$ who did not invest, invested and not punished, invested and punished 40%, invested and punished 100% (in TA_{1-3} and TB_{4-6}). Respectively, allocators in generation t are informed about the percentage of allocators in $t-1$ who returned 6€ or nothing to investors. Finally, all subjects in generation t are informed about the percentage of subjects in $t - 1$ who vote for $\lambda = 1$, vote for $\lambda = 0.4$ or do not vote.

At the same time, additional to the aforementioned information subjects are allowed to pass on a costly, voluntary advice to their successors (vertical transmission). The form and the cost of the message depends on the subject's role. If the subject is an investor then he/she can send to his/her investor-successor only one of the following messages:

- Do not send any money to the other player.
- Send 3€ and if you are not returned any money back, do not destroy other's player earnings.
- Send 3€ and if you are not returned any money back, destroy 40% (6€) of other's player earnings, although this action costs you 1.8€.
- Send 3€ and if you are not returned any money back destroy 100% (15€) of other's player earnings, although this action costs you 3€.

⁷The number of generations depends on the space restrictions of the laboratory where this experiment is going to be conducted.

⁸Each one of the 3 investors has played TGP for 3 periods

Obviously, in TA_{1-3} and TB_{4-6} this last advice is not included in the potential set of advices as investors are restricted to punish up to 40% of allocators' payoffs.

If the subject is an allocator then he/she can send to his/her allocator-successor only one of the following messages:

- Return nothing back to the other player.
- Return 6€ back to the other player.

Finally, in the last 3 periods of both treatments, subject, irrespectively of his role, can send to his/her successor only one of the following messages⁹:

- Vote $\lambda = 1$
- Vote $\lambda = 0.4$
- Do not vote.

The cost c of advice is recuperated by an predecessor only in the case that the successor follows predecessor's advice during the first period. The cost of advice for investors and allocators is proportional to the difficulty of its recuperation. For investors in TA_{1-3} and TB_{4-6} , whom probability of his/her advice to be followed is 25%, the cost is $c_{I1} = 0.25$. For investors in TA_{4-6} and TB_{1-3} , whom probability of his/her advice to be followed is 33%, the cost is $c_{I2} = 0.33$. For allocators, whom probability of his advice to be followed is 50%, the cost is $c_{A1} = 0.50$. Finally, for all subjects in the last 3 periods of both treatments whom probability of his advice to be followed is 33%, the cost is $c_v = 0.33$. As in the case of voting described in the static game, subjects are given the corresponded additional c as an extra payment. If they decide not to advise or to advise and their advice after all is followed, they earn an additional positive payoff c . On the other hand, if they decide to advise and their advice is ignored then this extra payment is never given to the subject.

⁹Assuming that players have been randomly placed, the sequence of A'_i actions are described in the appendix

Figure 5.2.: Two Generations Game

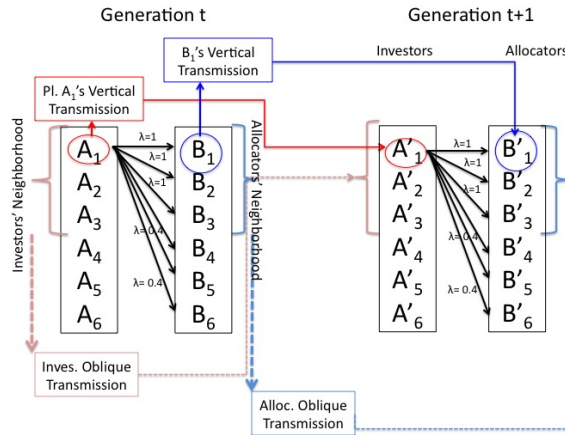

Subjects' payment are also related to their successors performance in a more direct way. Each subject receive an additional payment equal to the $\frac{1}{3}$ of the earnings of his/her corresponded successor¹⁰, no matter whether the former has sent an advice or not. Thus, the total payoffs of an agent are equal to the sum of what an agent earns during his "lifetime" plus a $\frac{1}{3}$ of what his/her successor earns in the next generation minus a fixed (recuperable) amount of money c when advising is taking place.

The figure above illustrates the game between two different generations.

Red arrows represent the messages transmitted from investors while the blue arrows are referred to allocators. Dashed arrows correspond to oblique transmission messages towards the whole neighborhood while compact (red or blue) arrows to the vertical costly messages by one particular agent of generation t to his/her corresponded successor in generation $t + 1$. The black arrows describe the Trust game played in the first three periods by player A_1 .

5.3. EPILOGUE

To sum up, in this thesis I attempted to show how biological, economic and cultural factors can affect the economic outcomes of a society. The interaction of all these factors results on shaping individuals' preferences which in turn have an effect on economic outcomes. The

¹⁰Successor's payoff remains the same.

intergenerational transmission model help us understand how the new prevalent preferences evolves from one generation to the other, while at the same time it predicts the resulting final Culture. Throughout this intergenerational process, the role of institutions is proven vital. Punishment capacity entails credible threaten which results on Fully or Quasi efficient outcomes. This punishment capacity's attribute is identified and acknowledged by agents. When the determination of the capacity level becomes agents' right through democratic processes, agents vote for high capacity levels. We conclude therefore that "democratization" will lead societies to efficiency. The only requisite is that the desired by the public high punishment capacity has to fairly, impartially, and consistently satisfy the Rule of the Law, as it expressed by Aristotle 2000 years ago.

PART IV.

RESUMEN DE LOS TRABAJOS EN CASTELLANO

RESUMEN DE LOS TRES TRABAJOS

EN CASTELLANO

Los seres humanos ni toman decisiones instintivas como los animales ni son máquinas precisas que maximizan funciones objetivos. Muy probablemente no son ni lo uno ni lo otro sino que decisiones quedan sujetas a lo que llevan heredado de su patrimonio económico, biológico y cultural. Esta tesis es un intento de estudiar estos tres ámbitos del patrimonio humano y sus efecto sobre decisiones reales de los agentes, lo que llamamos decisiones económicas.

6.1. TRABAJO 1: AUTODISCRIMINACIÓN: UN EXPERIMENTO DE CAMPO

SOBRE OBESIDAD.

Dentro del ámbito biológico, me concentro en el papel de la obesidad como una fuente de auto-discriminación, es decir si las personas que se ven como más obesas tienen un comportamiento distinto a las demás. Nuestro entorno experimental investiga si las personas que auto-reportan que son obesas responden de manera diferente ante una oportunidad. Concretamente, vemos si cuando se enfrentan a la oportunidad de ganar una cantidad positiva de dinero (que se les ofrece de verdad), los que se autodefinen como “más obesos que la media” piden menos dinero. Lo que encontramos son solicitudes de dinero significativamente inferiores de las personas obesas. Lo que nos lleva a confirmar nuestra hipótesis de

6.2. TRABAJO 2: EL EFECTO DE LA RENTA REAL EN EXPERIMENTOS DE BIENES PÚBLICOS CON DOTACIONES HETEROGENEAS.

auto-discriminación. Este resultado es importante porque ofrecemos una explicación adicional (paralela) para las diferencias salariales. Por lo tanto, parece que las personas obesas ganan menos, no sólo por la discriminación contra ellos, sino también porque ellos mismos son menos exigentes. Dos explicaciones distintas se sugieren: las personas obesas piden menos debido a la vulnerabilidad de sus autoestima y / o debido a algún tipo de profecía auto-cumplida (anticipan que los demás les van a discriminar).

6.2. TRABAJO 2: EL EFECTO DE LA RENTA REAL EN EXPERIMENTOS DE BIENES PÚBLICOS CON DOTACIONES HETEROGENEAS.

El segundo trabajo se concentra en un ámbito mucho más económico: la interacción entre la dotación inicial y la riqueza heterogénea. Este tema es importante porque conecta distribución inicial (de ricos y pobres por ejemplo) con políticas de redistribución (traspasos, transferencias, etc.). La estrategia que tomamos es la siguiente: los sujetos se revelan su nivel de riqueza antes de entrar en el laboratorio (eso lo sabemos por una encuesta sobre nivel socio económico) y los podemos clasificar como pobres y ricos. Con la información de la vida real (la de fuera del laboratorio) formamos grupos de 4-personas que juegan el Juego de los Bienes Públicos recibiendo dotaciones (en el juego) iniciales que son diferentes. Tenemos sujetos que reciben tal como son en la vida real (ricos reciben mas y pobres menos) o, de manera aleatoria: una máquina decide quien es rico en el lab y esto es independiente de la vida real. Lo interesante es que dotar a los sujetos según o en contra de su riqueza da lugar a una serie de resultados muy interesados. Tanto la heterogeneidad en las dotaciones como la falta de información sobre la riqueza relativa y/o ser “rico” dentro como fuera del laboratorio eleva las contribuciones. Por ultimo, cuando se revelan la creencias de los sujetos, nos encontramos que los sujetos que son relativamente “pobres”(fuera del laboratorio) esperan que demás contribuyan más de lo que realmente están dispuestos a contribuir ellos mismos, es decir, consideran que los ricos tienen la obligación de ser más cooperativos que ellos.

6.3. TRABAJO 3: LA TRANSMISIÓN INTERGENERACIONAL DE CONFIANZA:

EL EFECTO DEL CASTIGO ENDOGENO

El último trabajo es un esfuerzo teórico por analizar como las cuestiones culturales tienen un efecto sobre las decisiones. Más allá de esa idea damos un paso más adelante: queremos analizar qué ocurre cuando las cuestiones culturales se heredan a lo largo de las dinastías. Para analizar este problema tomamos la estructura de un juego de la confianza de generaciones traslapadas con castigo, donde hay transmisión cultural de las preferencias. En este entorno concreto se investiga: la interacción y la evolución entre las preferencias de reciprocidad (ojo por ojo) del sujeto que ha de confiar en los demás (el que primero mueve en el juego) y la voluntad de castigar el comportamiento hostil por parte de los inversores. Como es lo habitual en este tipo de modelos, el comportamiento a largo plazo de esta sociedad resulta del estado estable de la dinámica, que caracteriza las diferentes culturas. En nuestro trabajo, nos centramos en el efecto de la capacidad de castigo de la sociedad, como un factor determinante para la exitosa implementación de una cultura de máxima cooperación conduciendo en un resultado socialmente eficiente. Nuestro resultado principal indica que el equilibrio completamente cooperativo es posible bajo unas condiciones muy concretas: si la capacidad de castigo es suficientemente alta y su coste unitario suficientemente bajo. Dicho de otro modo, si se cumplen ambas condiciones, cualquier economía, independiente de las condiciones iniciales, se convergirá a un equilibrio eficientemente cooperativo. Cuando la capacidad de castigo es endógena, el resultado eficiente se logra más rápido y con mayor probabilidad, mientras se desaparece cualquier posibilidad que la economía se converja en un equilibrio ineficiente.

PART V.

BIBLIOGRAPHY

BIBLIOGRAPHY OF INTRODUCTION

Bisin, A., and Verdier, T., (2001), The Economics of Cultural Transmission and the Dynamics of Preferences, *Journal of Economic Theory*, 97, 2: 298-319.

Bisin, A., and Verdier, T., (2001a), The Economics of Cultural Transmission and the Dynamics of Preferences, *Journal of Economic Theory*, 97, 2: 298-319.

Bisin, A and Verdier, T. (2000): "Beyond the Melting Pot: Cultural Transmission, Marriage and the Evolution of Ethnic and Religious Traits," *Quarterly Journal of Economics*, 115, 955-988.

Bisin, A and Verdier, T. (2001b): "Agents with Imperfect Empathy Might Survive Natural Selection," *Economics Letters*, 2, 277-85

Bisin, A and Verdier, T. (2005): "Work Ethic and Redistribution: A Cultural Transmission Model of the Welfare State," mimeo, New York University.

Botticini, M., and Z. Eckstein (2005): Jewish occupational selection: education, restrictions, or minorities? *Journal of Economic History*, 65: 922-948

Fernández R. (2008): Culture and Economics, in *New Palgrave Dictionary of Economics*, ed. by S. Durlauf, and L. Blume. Palgrave Macmillan, Basingstoke and New York, 2nd end.

Greif, A. (1994) Cultural Beliefs and the Organization of Society: A Historical and Theoretical Reflection on Collectivistic and Individualistic Societies. *Journal of Political Economy*. 102(5): 912-50

Greif, A. (2006) *Institutions and the path of Modern Economy: Lessons from Medieval Trade*. Cambridge: Cambridge University Press.

Guiso, L., P. Sapienza, and L. Zingales (2004): *The Role of Social Capital in Financial Development*. *The American Economic Review*, 94: 526-556.

Guiso, L., P. Sapienza, and L. Zingales (2006): *Does Culture Affect Economic Outcomes?*, *Journal of Economic Perspectives*, 20, 23-48

Henrich, J., R. Boyd, S. Bowles, C. F. Camerer, E. Fehr, H. Gintis, and R. McElreath (2001): *In search of Homo economicus: Behavioral experiments in 15 small-scale societies*, *American Economic Review*, 91(2), 73-78.

Kroeber, A., and C. Kluckhohn (1952): *Culture*. Meridian Books, New York

Rob R., Zemsky P., (2002) *Social capital, corporate culture, and incentive intensity*. *RAND Journal of Economics* 33(2): 243-257

Robson and Samuelson (2010) *The evolution of decision and experienced utilities*. Working paper.

Tabellini, G. (2010): *Culture and Institutions: Economic Development in the Regions of Europe*. *Journal of the European Economic Association*, forthcoming

BIBLIOGRAPHY OF ESSAY 1

Andreoni, J. and Petrie, R. (2008). Beauty, gender and stereotypes: Evidence from laboratory experiments. *Journal of Economic Psychology* **29**: 73–93.

Atella, V., Pace, N., Vuri, D. (2008). Are employers discriminating with respect to weight? European Evidence using Quantile Regression. *Economics and Human Biology*, **6**: 305–329

Barron, L. (2003) Ask and you shall receive? Gender differences in negotiators' beliefs about requests for higher salary. *56*(6): 635-662

Baumeister, R. F., Campbell, J. D., Krueger, J. I., Vohs, K. E. (2003). Does high self-esteem cause better performance, interpersonal success, happiness, or healthier lifestyles? *Psychological Science in the Public Interest*, **4**, 14.

Biro, Frank, Ruth Striegel-Moore, Debra Franko, Justina Padget and Judy Bean. 2006. Self-Esteem in Adolescent Females, *Journal of Adolescent Health*, **39**: 501-7.

Brunello G., D'Hombres B. (2007). Does body weight affect wages? Evidence from Europe. *Economics and Human Biology*, **5**: 1–19

Burkhauser, R.V., Cawley, J., 2008. Beyond BMI: the value of more accurate measures of fatness and obesity in social science research. *Journal of Health Economics* **27**, 519-29.

Carr D, Friedman MA. Is obesity stigmatizing? Body weight, perceived discrimination, and psychological well-being in the United States. *J Health Soc Behav* 2005;**46**:244-59.

Cawley J. (2004). The impact of Obesity on Wages. *The Journal of Human resources*, **39** (2): 451–474

-
- Cawley J. (2007). The labor market impact of obesity. In: Acs, Z., Lyles, A. (Eds.), *Obesity, Business, and Public Policy*. Edward Elgar Publishers, Northampton: 766.
- Cawley, J., Danziger, S., 2005. Morbid obesity and the transition from welfare to work. *Journal of Policy Analysis and Management* **24**, 727-743.
- Chertkoff, J. & Conley, M. Opening offer and frequency of concession as bargaining strategies. *Journal of Personality and Social Psychology*, 1967, 7, 181.
- Croson, R., Gneezy, U. (2009). Gender differences in preferences. *Journal of Economic Literature*, 47, (2): 448-474
- Eckel, C., & Grossman, P. (2001). Chivalry and solidarity in ultimatum games. *Economic Inquiry*, **39**(2): 171–188
- Galinsky, A. & Mussweiler, T. First offers as anchors: The role of perspective-taking and negotiator focus. *Journal of Personality and Social Psychology*, 2001, 81, 6579.
- Garcia, J., Quintana-Domeque, C., 2006. Obesity, employment and wages in Europe. In: Bolin, K., Cawley, J. (Eds.), *Advances in Health Economics and Health Services Research*. Elsevier, Amsterdam: 189-199.
- Gerhart, B. (1990) Gender differences in current starting salaries: The role of performance, college major and job title. *Industrial and Labor Relations Review* 43, 418-433.
- Goldin, C. (1990). *Understanding the gender gap*. New York: Oxford Univ. Press.
- Greig, F. (2008) Propensity to Negotiate and Career Advancement: Evidence from an Investment Bank that Women Are on a “Slow Elevator”. *Negotiation Journal* **24**(4):495-508
- Hamermesh, D., & Biddle, J. (1994). Beauty and the labor market, *American Economic Review* **84**(5): 1174–1194.
- Han, E., Norton, E., Stearns, S. (2009). Weight and wages: Fat versus lean paychecks. *Health Economics*, **18**: 535–548

Hatfield, E., & Sprecher, S. (1986). *Mirror, mirror: The importance of looks in everyday life*. Albany: State University of New York Press.

Heckman, James J. Policies to Foster Human Capital. *Research in Economics*, 2000, 54(1), pp. 36.

Hesketh, K. M. Wake and E. Waters. 2004. Body Mass Index and Parent-Reported Self-Esteem in Elementary School Children: Evidence for a Causal Relationship. *International Journal of Obesity*, 28: 1233-7.

Johansson, E., Böckeman, P., Kiiskinen, U., Heliövaara, M. (2009). Obesity and labour market success in Finland: The difference between having a high BMI and being fat. *Economics and Human Biology*, 7: 36–45

Liebert, R., Smith, W., Hill, J., Keiffer, M. The effects of information and magnitude of initial offer on interpersonal negotiation. *Journal of Experimental Social Psychology*, 1968, 4, 4314.

Major, B. (1994) From social inequality to personal entitlement: The role of social comparisons, legitimacy appraisals, and group membership. *Advances in Experimental Social Psychology*, 26, 293-55.

Merton R. (1948) The Self-Fulfilling Prophecy. *The Antioch Review*, 8 (2) :193-210

Miller, C., & Downey, K. (1999). A meta-analysis of heavyweight and self-esteem. *Personality and Social Psychology Review*, 3(1): 68–84

Mobius, M., & Rosenblat, T. (2006). Why beauty matters. *American Economic Review*, 96(1): 222–235.

O'Neill, J. (1998). The trend in the male–female wage gap in the United States, Ferber, Marianne (Ed.), *Women in the Labour Market*. Volume 1, Elgar Reference Collection. *International Library of Critical Writings in Economics*, 90: 520–545

O'Neill, J. (2003). The gender gap in wages, circa 2000. *American Economic Review*, 93(2): 309–314

French S. A., Story M., Perry C. L. 1995. Self-esteem and Obesity in Children and Adolescents: A Literature Review. *Obesity Research*, 3:479-90.

Persico, Nicola; Postlewaite, Andrew and Silverman, Dan. The Effect of Adolescent Experience on Labor Market Outcomes: The Case of Height. *Journal of Political Economy*, 2004, 112(5), pp. 1019-33

Piketty T. (1998) Self-fulfilling beliefs about social status. *Journal of Public Economics*, 70: 115-132

Puhl, R., Heuer, C. (2009). The stigma of obesity: A review and update. *Obesity*, 17: 941–964

Ritov, I. Anchoring in simulated competitive market negotiation. *Organizational Behavior and Human Decision Processes*, 1996, 67, 165.

Roehling M., Pilcher, S., Oswald F., Bruce T. (2008). The effects of weight bias on job-related outcomes: a meta-analysis of experimental studies. *Academy of Management Annual Meeting*, Anaheim, CA.

Rooth (2009). Obesity, attractiveness, and differential treatment in Hiring. A field experiment. *The Journal of Human Resources*. 44 (3): 710.

Rosenbaum, J.(1984) *Career mobility in a corporate hierarchy*. Orlando, FL: Academic Press,

Small, D., Gelfand, M., Babcock, L., Gettman, H. Who goes to the bargaining table? The influence of gender and framing in initiation of negotiation. *Journal of Personality and Social psychology*, 93: 600-613

Solnick, S.J., Schweitzer M.E. (1992). Influence of Physical Attractiveness and Gender on Ultimatum Game Decisions. *Organizational Behavior and Human Decision Processes* 79(3): 199–215.

Tversky, A., Kahneman, D. (1974, September). Judgment under uncertainty: Heuristics and biases. *Science*, 185, 1124-1131

Wada, R. & Tekin, E. (2010). Body composition and wages. *Economics and Human Biology*, **8**: 242–254

Wade, M.(2001)Women and salary negotiation: The costs of self-advocacy. *Psychology of Women Quarterly*, 25, 656.

Wang, S., Brownell, K., Wadden, T. (2004) The influence of the stigma of obesity on overweight individuals. *International Journal of obesity*, 28: 1333-1337

Wardle, J., & Cooke, L. (2005). The impact of obesity on psychological well-being. *Best Practice & Research Clinical Endocrinology & Metabolism*, 19, 42140.

Wimmer, H. & Perner, J. (1983). Beliefs about beliefs: Representation and constraining function of wrong beliefs in young children's understanding of deception. *Cognition*, **13**: 41–68

Zebrowitz, L. (1997). *Reading faces: Window to the soul?* Boulder, CO: Westview Press.

BIBLIOGRAPHY OF ESSAY 2

Anderson, L.R., Mellor, J.M., Milyo, J. (2008) Inequality and public good provision: An experimental analysis. *Journal of Socio-Economics* **37**, 1010–1028.

Bagnoli, M., McKee, M., (1991) Voluntary contribution games: efficient private provision of public goods. *Economic Inquiry* **29**, 351–366.

Brookshire, D., Coursey, D., Redington, D., (1993) Special interests and the voluntary provision of public goods. Discussion Paper, University of New Mexico.

Buckley, E., Croson, R. (2006) Income and wealth heterogeneity in the voluntary provision of linear public goods. *Journal of Public Economics* **90**, 935–955.

Burns, J., Visser M., (2008) Income Inequality and the Provision of Public Goods: When the Real World Mimics the Lab. Working Paper

Cardenas, J.-C., (2003) Real wealth and Experimental Cooperation: Experiments in the Field Lab. *Journal of development Economics*. **29**, 54–69.

Chan, K.S., Mestelman, S., Moir, R., Muller, R. A. (1996) The voluntary provision of public goods under varying income distributions. *Canadian Journal of Economics* **70(2)**, 263–289.

Chan, K.S., Mestelman, S., Moir, R., Muller, R.A., (1999) Heterogeneity and the voluntary provision of public goods. *Experimental Economics* **2**, 5–30.

Cherry, T.L., Croll, S., Shogren, J.F., (2005) The impact of endowment heterogeneity and origin on public good contributions: evidence from the lab. *Journal of Economic Behavior Organization* **57**, 357–365.

Dana, J., Weber, R.A, Xi Kuang, J., (2006) Exploiting moral wiggle room: experiments demonstrating an illusory preference for fairness. *Economic Theory* **33(1)**, 67–80.

Fisher, J., Isaac, R.M., Schatzberg, J., Walker, J.M., (1994) Heterogeneous demand for public goods: behavior in the voluntary contributions mechanism. *Public Choice* **85**, 249–266.

Ledyard, J.O., (1995) Public goods: a survey of experimental research. In: Kagel, J., Roth, A. (Eds.), *Handbook of Experimental Economics*. Princeton University Press, Princeton, pp. 111–194.

Marwell, G., Ames, R., (1979) Experiments on the provision of public goods. I: Resources, interest group size, and the free-rider problem. *American Journal of Sociology* **84**, 1335–1360.

Marwell, G., Ames, R., (1980) Experiments on the provision of public goods. II: Provision points, stakes, experience, and the free rider problem. *American Journal of Sociology* **85**, 926–937.

Nyborg, Karine, (2000) Homo Economicus and Homo Politicus: interpretation and aggregation of environmental values, *Journal of Economic Behavior Organization*, Elsevier, **42(3)**, 305-322.

Pinkley R.L., Griffith T.L. and Northcraft G.B., (1995) "Fixed Pie" a la Mode: Information Availability, Information Processing, and the Negotiation of Suboptimal Agreements. *Organizational Behavior and Human Decision Processes* **62(1)**, 101–112.

Rapoport, A., Suleiman, R., (1993) Incremental contribution in step-level public goods games with asymmetric players. *Organizational Behavior and Human Decision Processes* **55**, 171–194.

Sadrieh, A., Verbon, H.A.A., (2004) Inequality, cooperation, and growth: an experimental study. *Experimental Economics* **6**, 1197–1222.

Stewart, L.A., (2009) Selective Beliefs over Preferences. Working Paper

Zelmer, J., (2003) Linear Public Good Experiments: A Meta-Analysis *European Economic Review* **50**, 299–310.

BIBLIOGRAPHY OF ESSAY 3

Aghion P., Algan, Y. and Cahuc, P., (2008), Can Policy Influence Culture? Minimum Wage and the Quality of Labor Relations, Harvard Working Paper.

Algan, Y. and Cahuc, P., 2007, Social Attitudes and Economic Development: An Epidemiological Approach, IZA Working Paper n°2235.

Arrow, K.J (1972), "Gifts and exchanges", *Philosophy and Public Affairs*, 1:343-62

Bagwell, K., Staiger R., (2009) Delocation and trade agreements in imperfectly competitive market. Working Paper.

Boyd, R. and Richerson, P., (1985), *Culture and the Evolutionary Process*, Chicago: University of Chicago Press.

Berg, J., Dickhaut, J., McCabe, K., (1995). Trust, reciprocity, and social history. *Games and Economic Behavior* 10, 122-42.

Bisin, A., and Verdier, T., (2001), The Economics of Cultural Transmission and the Dynamics of Preferences, *Journal of Economic Theory*, 97, 2: 298-319.

Bohnet, I., Grief, F., Herrman, B. and Zeckhauser, R. (2008) Betrayal aversion: evidence from Brazil, China, Oman, Switzerland, Turkey and the United States. *American Economic Review*, 98, 294-310.

Boyd, R., Gintis, H., Bowles, S., Richerson, P. J. (2003). Evolution of altruistic punishment. *Proceedings of the National Academy of Sciences*, 100, 3531-3535.

Carpenter, Jeffrey, (2007) unishing Free-Riders: How Group Size Affects Mutual Monitoring and the Provision of Public Goods, *Games and Economic Behavior* 60,1 :311.

Cavalli-Sforza, L. and Feldman, M., (1981), *Cultural Transmission and Evolution: A Quantitative Approach*. Princeton University Press, Princeton NJ.

Dawes C.T, Fowler J.H, Johnson T, McElreath R, Smirnov O. (2007) Egalitarian motives in humans. *Nature*. 446, 79496

Fehr, E., Gächter, S., Kirchsteiger, G., (1997). Reciprocity as a contract enforcement device. *Econometrica* 65 (4), 83360.

Fehr, E., Kirchler, E., Weichbold, A., Gächter, S., 1998. When social norms overpower competition: gift exchange in experimental labor markets. *Journal of Labor Economics* 16 (2), 32451.

Fehr, E., Gächter, S., 2000. Cooperation and punishment in public goods experiments. *American Economic Review* 90 (4), 98094.

Fehr, E., Fischbacher, U., 2002. Why social preferences matter: the impact of non-selfish preferences on competition, cooperation, and incentives. *The Economic Journal* 112, C133.

Fehr, E., Gächter, S., 2002. Do incentive contracts crowd out voluntary cooperation? University of Zurich Institute for Empirical Research in Economics Working Paper No. 34.

Fehr, E., Rockenbach, B., 2003. Detrimental effects of sanctions on human altruism. *Nature* 422, 13740.

Gächter, S. and Herrmann, B. 2009 Reciprocity, culture and human cooperation: previous insights and a new cross-cultural experiment *Phil. Trans. R. Soc. B* 2009 364, 791-806

Gintis, H. (2008) Punishment and cooperation. *Science* 319, 1345346.

Guiso, L., Sapienza, P. and Zingales, L., 2006, Does Culture Affect Economic Outcomes?, *Journal of Economic Perspectives* 20(2):23-48.

Knack, S. and Keefer, P., 1997, Does Social Capital Have an Economic Payoff, A Cross-Country Comparison, *Quarterly Journal of Economics* 112(4):1251-1288.

Knack, S. and Zak, P., 2001, Trust and Growth, *Economic Journal* 111(470):295-321.

La Porta, R., Lopez-de-Silanes, F., Shleifer, A. and Vishny, R., 1999, The Quality of Government, *Journal of Law, Economics and Organizations* 15(1):222-279.

Lazzarini, S., Miller, G., Zenger, T., 2003. Order with some law: complementarity vs. substitution of formal and informal arrangements. *Journal of Law, Economics, and Organization* 20 (2), 26198.

Loewenstein G, Thompson L, Bazerman M 1989 Social utility and decision making in interpersonal contexts. *J. Pers. Soc. Psychol.* 57, 42641

Nikiforakis, N., (2008). Punishment and counter-punishment in public good games: can we really govern ourselves? *Journal of Public Economics* 92: 9112.

Olcina, G., Calabuig, V., (2008) Cultural Transmission and the Evolution of Trust and Reciprocity in the Labour Market, Working Paper BBVA Foundation , DT08/11.

Putnam, R. (2000) *Bowling Alone: The Collapse and Renewal of American Community*. New York: Simon Schuster.

Rigdon, M. (2009) Trust and reciprocity in incentive contracting. *Journal of Economic Behavior Organization*, 70(1-2): 93-105

Rhodes M., (1995) "Subversive liberalism": Market integration, globalization and the European welfare state. *Journal of European Public Policy* 2(3): 384 - 406

Rob R., Zemsky P., (2002) Social capital, corporate culture, and incentive intensity. *RAND Journal of Economics* 33(2): 243-257

Rockenbach, B. Milinski, M. 2006 The efficient interaction of indirect reciprocity and costly punishment. *Nature* 444,71823.

Tabellini G. (2008) The Scope of Cooperation: Values and Incentives. *Quarterly Journal of Economics* 123(3): 905-950

Zak, P. J. and Knack, S. (2001), Trust and Growth. *The Economic Journal*, 111: 295-321.

PART VI.

APPENDIX

APPENDICES OF ESSAY 1

11.1. DETAILED CHRONOLOGICAL DESCRIPTION OF THE METHODOLOGICAL PROCESS.

Three types of subjects participated in the experiment.

- a)** 2 head researchers (MR): Both researchers are members of the Department of Economic Theory and History at the University of Granada with broad experience in the experimental field. After designing the experiment, their main concern was to “train” the mediators to conduct an economic experiment correctly and inform them about basic experimental protocols related to this particular experiment. The researchers accomplished their mission through the analysis of the data and the writing of this report.
- b)** 27 mediators-interviewers (med): All the mediators were students enrolled in the course titled “Economic Analysis of Collective Relations” (2007) at the University of Granada. None of the mediators-interviewers had past experience in the experimental field aside from this particular class. Given that their participation as interviewers in the experiment had a solely pedagogical aim, they received a final grade for a presentation based on the results/conclusions drawn from the data. Communication between the interviewers and researchers mainly occurred during the 3-hour class. Some additional instructions and data were provided via e-mail.
- c)** 269 subjects (subj): All the subjects were related to the interviewers in three different

11.1. DETAILED CHRONOLOGICAL DESCRIPTION OF THE METHODOLOGICAL PROCESS.

ways: 1) friends (59.6%); 2) family members (20%); and 3) colleagues (20.4%). While the experiment was being conducted (answering questionnaires), the subjects were in their natural environment.

STEP 1. STARTING DATE: OCTOBER 23, 2007

A. General experimental instructions provided to mediators (Duration: 3 hours)

The mediators received general information about experimental procedures, emphasizing important features of experiments such as anonymity, protection of personal data, the no-deception rule, payments, etc.

STEP 2. STARTING DATE: OCTOBER 30, 2007

A. Specific experimental instructions provided to mediators (Duration: 3 hours)

Mediators were informed that they were going to participate as interviewers in a socioeconomic experiment. To do so, each of the interviewers was asked to find 10 subjects willing to answer some questionnaires. At this point, the only information interviewers received and had to pass on to their subjects was as follows:

1. Both subjects and interviewers are required to fill out a questionnaire of a socioeconomic nature. The questionnaire takes subjects 15 minutes to complete and interviewers about 1 hour.
2. The questionnaires are totally anonymous (the completed questionnaires will be returned to the head researchers in sealed envelopes). The data will be extracted in a confidential manner and recoded by the 2 chief researchers to prevent interviewers from identifying their subjects in any of the remaining steps of the procedure.
3. Interviewers must ensure that the subjects understand that the experiment is of a socioeconomic nature by emphasizing the fact that subjects will receive money for their participation at the end of the experiment.

At this point, more detailed instructions were given to the interviewers (about who was sponsoring the experiment and why) in order to convince them that the payments would be made and would not affect any of the interviewers' or researchers' budgets.

B. Searching for subjects and drawing up a list of names. (Duration: 1 week) The interviewers were required to find 10 subjects within one week's time who were willing to participate in the experiment according to the above instructions. By the end of the week, interviewers were asked to submit a copy of a coded list of the subjects' names in order to protect their anonymity.

STEP 3. STARTING DATE: NOVEMBER 6, 2007

A. Subjects' list, interviewers' questionnaires(Q1) (see Appendix G) and some additional instructions. (Duration: 3 hours) During a 3-hour class, researchers handed in a copy of the interviewers' coded name list. The researchers kept another copy in order to remember the order they had assigned to each subject in order to complete questionnaire Q1. In Q1, the interviewers had to answer questions related to the physical and psychological characteristics of each of their subjects (part A). A modified version of the Sally-Ann task (a well-known psychological experiment) was included in the questionnaire for distracting subjects attention (part B).

Moreover, highly detailed instructions were given to interviewers about each of the questions for two main reasons. First, the researchers wanted to be sure that the interviewers had understood the questions correctly so that they would give the most appropriate answer. Second, the researchers wanted to prepare the interviewers so that they would be able to solve any problems that the subjects might encounter when answering questionnaire Q2 (see appendix H) under the supervision of their corresponding interviewer (the researchers were not present at this phase). It should be emphasized that, at this point, the researchers did not yet allow the interviewers to know that they were going to answer the same questions as their subjects (although in this case the subjects described their own selves). The reason why the

11.1. DETAILED CHRONOLOGICAL DESCRIPTION OF THE METHODOLOGICAL PROCESS.

researchers decided not to let this information become common-knowledge is because most of the interviewers and subjects were either friends or family members and such information may induce interviewers to answer in a more “friendly” way.

After the interviewers filled out questionnaire Q1 and handed them back to the researchers, they were given questionnaire Q2. Each interviewer received 10 Q2 questionnaires and 10 envelopes to deliver to their subjects. Furthermore, the interviewers were given additional instructions related to part C of questionnaire Q2, which was not included in questionnaire Q1. At this point, the subjects were clearly informed that they could earn some money from this process by answering the corresponding question in part C of questionnaire Q2, which asks subjects to provide their full home-address in order to mail them the money. They were finally told that the experiment was completely anonymous and the subjects’ answers must be returned in sealed envelopes.

B. Handing out and receiving back answers for questionnaires Q2 (Duration: 2 weeks) Over the next two weeks, the interviewers were required to deliver questionnaire Q2 and the envelope to their subjects and explain how to fill them out following the researchers’ instructions.

STEP 4. STARTING DATE: NOVEMBER 20, 2007

A. Receiving back questionnaires Q2 and discussion. (Duration: 3 hours) At this stage, the interviewers returned the sealed envelopes with the subjects’ answers and had time to discuss any problems that may have arisen during the process. In general, the interviewers encountered no problems regarding the comprehension and answering of the Q2 questionnaires. In some cases, the interviewers were asked to give additional explanations about the Sally-Ann task. However, as the interviewers had been properly trained (and had also carried out the same task), they were able to answer the subjects’ questions. Moreover, most of the subjects asked the interviewers to confirm if the question regarding payment for their participation in the experiment was true (part C in questionnaire Q2). Once again, the

interviewers were able to clarify that not only was the question totally true, but also that the money had been provided by a governmental/local research institute that had nothing to do with either the researchers' or the interviewers' budget. This reaction by the subjects was expected since the experiment was held in the subjects' natural environment and their interviewers were mostly friends or family members. For this reason, the researchers insisted that consistent instructions be given in advance.

B. Data extraction (Duration: 2 weeks) Over the following two weeks, raw data were extracted from both the Q1 and the Q2 questionnaires. The data were also recoded and given back to the interviewers for further elaboration as part of a project they were required to do for the course on Economic Analysis of Collective Relations, thus protecting the anonymity of the subjects.

STEP 5. STARTING DATE: DECEMBER 4, 2007

A.Data delivery and payment instructions (Duration: 3 hours) In this stage, the raw-recoded data was given to the interviewers together with a description of the variables. As regards the payment process, the majority of the interviewers preferred to receive the subjects' payments on their behalf instead of mailing the money to them. To do so, the interviewers were asked to submit, within two weeks time, signed copies of the ID cards for those subjects who asked for money in the corresponding question in part C of questionnaire Q2.

B. Collecting subjects IDs (Duration: 2 weeks) Over the following two weeks, the interviewers were asked to copy the subjects' ID cards and submit them to the researchers in order to receive the payments.

11.1. DETAILED CHRONOLOGICAL DESCRIPTION OF THE METHODOLOGICAL PROCESS.

STEP 6. STARTING DATE: DECEMBER 18, 2007

A. Payments (Duration: 3 hours) After submitting a signed copy of the subjects' ID cards to the researchers, the interviewers received the payments on behalf of their subjects . The payment was correlated to part C of questionnaire Q2. Of course it was impossible for subjects to receive a payment for the exact amount of money they requested. The researchers decided to pay: a) 10 euros to the subjects who requested 10 or more euros (in part C); and b) the exact amount to the subjects who requested less than 10 euros. The interviewers paid 89 subjects a total of 854 euros.

11.2. NONPARAMETRIC TEST ANALYSIS.

In order to test if the differences illustrated in the *Preliminary Results* section were also significant, we performed a nonparametric test for trend across ordered groups. The test is a useful adjustment of the Kruskal-Wallis test for ordered variables and was first used by Cuzick¹. In the following table we report Cuzick's z-statistic and the corresponding significance level. The test was performed separately for the three variables *money(.)*, *money(1/0)* and *money(> 0)* generated in the previous section. Cuzick's z-statistic tests the null hypothesis that all medians (across the different groups of *beauty*² or *obesity*) are the same ($H_0 : \theta_1 = \theta_2 = \dots = \theta_k$) against the alternative hypothesis that the medians are ordered in magnitude ($H_a : \theta_1 \leq \theta_2 \leq \dots \leq \theta_k$). If the alternative hypothesis is true, then at least one of the differences is a strict inequality (>).

Variable	<i>money(.)</i>		<i>money(1/0)</i>		<i>money(> 0)</i>	
	<i>z</i>	<i>Pr > z </i>	<i>z</i>	<i>Pr > z </i>	<i>z</i>	<i>Pr > z </i>
<i>obesity</i>	-1.96	0.051	-1.11	0.267	-2.32	0.021
<i>beauty</i>	2.12	0.034	2.25	0.025	0.24	0.807
<i>female</i>	-0.08	0.933	1.46	0.144	-0.81	0.418

As we can see regarding the variable *money(.)*, a significant positive trend among the different groups of beauty and a negative trend among the different groups of obesity is confirmed. Nevertheless, this result holds only partially for *money(1/0)* and *money(> 0)*. For *money(1/0)* in particular, only the positive trend on *beauty* is significant, while for *money(> 0)* only the negative trend on *obesity* is significant³. Finally, no gender difference⁴ is confirmed for any dependent variable.

¹The Jonckheere-Terpstra test is a similar test in which the majority of cases confirmed Cuzick's test results.

²Note that when we refer to group "x" of a particular variable, we mean the group of subjects that have self reported level "x" on the Likert scale question in Q2 for this particular variable.

³We also perform the test for the variables *ambition* and *self-confidence*. A positive trend is confirmed only for *ambition* and only when *money* ($Pr > |z| = 0.035$) and *money(> 0)* ($Pr > |z| = 0.074$) are tested.

⁴The Cuzick-test is equal to the Mann-Whitney test for the binary variable *female*.

Unfortunately, in the case of rejecting the null hypothesis, the test does not give any information about how many or which groups have ordered medians. In order to disentangle the exact trends, we performed separate Mann-Whitney tests, testing for significant differences between two groups in each test

When performing the test for the variable *money(.)* for all possible *obesity* pairs of groups, we found a significant (negative) difference between the medians of group 4 and group 5 ($Pr. > |z| = 0.022$) and the medians of group 4 and group 6 ($Pr. > |z| = 0.025$). This result, which supports the claim in observation A, indicates that:

Nonparametric Result 1: People who consider themselves *obese* (level 5 or 6) request a lower amount of money than people who consider themselves neither *obese* nor *thin* (level 4).

For the variable *beauty*, the corresponding pairs that reveal a positive trend are group 1 with 7 ($Pr. > |z| = 0.079$), group 3 with 7 ($Pr. > |z| = 0.064$), and group 4 with 7 ($Pr. > |z| = 0.086$). In this case we have to take into account that groups 1, 3 and 7 included only 2, 9 and 10 observations, respectively, while group 4 included 97 observations. This also explains why all the above trends are only significant at the 10% level.

Nonparametric Result 2: People who consider themselves *beautiful* or *handsome* (level 7) request significantly more money than people who consider themselves either “ugly” (level 1 or 3) or *average beautiful* (level 4).

Moreover, regarding gender, the nonparametric tests do not confirm any significant difference in the corresponding money requests. Nevertheless, by splitting the data into two subsamples for males and females and replicating the above tests by gender, we realize that the negative trend between *obesity* and money requests holds only in the female sample ⁵.

This finding leads to the following conclusion:

⁵For the variable *money(.)*, *money(1/0)* and *money(> 0)*, level 5 and 6 “obese” females request significantly less money than “normal” females in level 4. For the variables *money(.)* and *money(1/0)*, “beautiful” males in level 7 request significantly more money than “normal” males in level 4 or “ugly” males in levels 1 and 2, but very few observations are included in these categories.

Nonparametric Result 3: Although no significant gender difference was found regarding the amount of money requested, there is evidence that the negative trend between money requests and *obesity* or *dobese* is mainly due to the participation of females in the sample.

11.3. SPEARMAN'S RANK CORRELATION COEFFICIENTS

<i>Variable</i>	<i>obesity</i>	<i>beauty</i>	<i>female</i>	<i>age</i>	<i>wage</i>	<i>ambition</i>	<i>self-conf</i>
<i>obesity</i>	1.00						
<i>beauty</i>	0.01	1.00					
<i>female</i>	-0.01	0.00	1.00				
<i>age</i>	0.10	-0.10	-0.10	1.00			
<i>wage</i>	0.04	-0.04	-0.24	0.63	1.00		
<i>ambition</i>	-0.02	0.10	-0.24	0.06	0.13	1.00	
<i>self-conf</i>	0.01	0.25	-0.14	-0.04	0.01	0.29	1.00

11.4. INTERVAL AND TOBIT REGRESSIONS.

Table 7: INTERVAL AND TOBIT REGRESSIONS				
<i>Variable</i>	Interval Regressions		Tobit Regressions	
	<i>money – interv(.)</i>		<i>money – cont.</i>	
	1(a)	1(b)	1(a)	1(b)
<i>obesity</i>	-8.27*		-8.61*	
	(5.08)		(5.10)	
<i>dobese</i>		-29.27***		-28.19***
		(9.67)		(9.63)
<i>dthin</i>		-14.64		13.14
		(15.38)		(15.29)
<i>beauty</i>	6.76	5.80	6.96	6.05
	(6.52)	(6.47)	(6.65)	(6.59)
<i>female</i>	-1.64	-1.40	-1.18	.921
	(12.66)	(12.83)	(12.68)	(12.86)
<i>age</i>	-10.32**	-10.19**	-10.39**	-10.27**
	(4.66)	(4.45)	(4.63)	(.080)
<i>age²</i>	.112*	.109*	.113*	.110*
	(.061)	(.059)	(.61)	(.059)
<i>wage</i>	.000	.001	-.0002	-.0007
	(.007)	(.008)	(.008)	(.008)
<i>ambition</i>	8.27*	8.47*	8.40*	8.62*
	(4.87)	(4.86)	(.123)	(4.81)
<i>self-conf</i>	.567	.066	.448	.053
	(.458)	(4.54)	(.458)	(.453)
<i>constant</i>	164.64**	144.27**	165.53**	143.11**
	(79.75)	(71.24)	(79.41)	(70.65)
N	269	269	269	269
cens.left	115	115	115	115
cens.right	24	24	24	24
<i>Pr > chi²</i>	0.0283	0.0048	0.0275	0.0018

NOTE: SE and Sign. level as previous tables. Left-censored observations (154) if *money(.)* = 0 and right-censored observations (24) if *money(.)* > 0

11.5. ADDING CONTROL VARIABLES IN ORDERED PROBIT REGRESSION

1(B).

Table 8: ORDERED PROBIT REGRESSIONS					
<i>Variable</i>	<i>money(.)</i>				
	1(b ₁)	1(b ₂)	1(b ₃)	1(b ₄)	1(b ₅)
<i>dobese</i>	-.42*** (.13)	-.42*** (.13)	-.43*** (.13)	-.43*** (.13)	-.42*** (.13)
<i>dthin</i>	-.15 (.20)	-.23 (.20)	-.17 (.20)	-.14 (.20)	-.15 (.20)
<i>beauty</i>	.15** (.07)	.11 (.07)	.13* (.07)	.11 (.07)	.14* (.07)
<i>female</i>	-.01 (.14)	-.05 (.14)	-.10 (.14)	.03 (.15)	.01 (.14)
<i>age</i>		-.13** (.06)			
<i>age</i> ²		.001* (.000)			
<i>wage</i>			-.0002** .0001		
<i>ambition</i>				.10** (.05)	
<i>self-conf</i>					.03 (.05)
N	269	269	269	269	269
<i>Pr > chi</i> ²	0.0006	0.0000	0.0001	0.0017	0.0017

NOTE: SE and Sign. level as previous tables.

11.6. PROBIT REGRESSIONS BY GENDER.

Table 9(a): PROBIT REGRESSIONS BY GENDER						
Variable	Female Sample					
	money(.)		money(1/0)		money(> 0)	
	1(a)	1(b)	2(a)	2(b)	3(a)	3(b)
<i>obesity</i>	-0.117 (.094)		-.044 (.114)		-.281* (.164)	
<i>dobese</i>		-.685*** (.208)		-.624** (.266)		-.685*** (.208)
<i>dthin</i>		-.415 (.315)		-.566 (.341)		-.415 (.315)
<i>beauty</i>	.077 (.106)	.068 (.102)	.102 (.109)	.089 (.105)	-.040 (.138)	.068 (.102)
<i>age</i>	-.088 (.070)	-.077 (.063)	-.076 (.080)	-.061 (.073)	-.097 (.072)	-.076 (.064)
<i>age²</i>	.001 (.001)	.001 (.001)	.001 (.001)	.001 (.001)	.001 (.001)	.001 (.001)
<i>wage</i>	-.000 (.0001)	-.000 (.000)	-.0001 (.0001)	-.0002 (.0001)	.000 (.0002)	-.000 (.0001)
<i>ambition</i>	.089 (.080)	.094 (.081)	.077 (.095)	.081 (.098)	.080 (.075)	.094 (.082)
<i>self-conf</i>	.006 (.084)	-.017 (.083)	-.038 (.084)	-.071 (.081)	.119 (.076)	-.017 (.083)
<i>constant</i>			1.321 (1.558)	1.42 (1.408)		
N	148	148	148	148	88	88
<i>Pr > chi2</i>	0.057	0.0000	0.0805	0.0000	0.0326	0.0013

Note: Standard errors (adjusted for 27 clusters in interviewers) of parameter estimates in parentheses. Significance level are marked with * for $p \leq 0.10$, ** for $p \leq 0.05$, and *** for $p \leq 0.01$.

Table 9(b): PROBIT REGRESSIONS BY GENDER

Variable	Male Sample					
	<i>money(.)</i>		<i>money(1/0)</i>		<i>money(> 0)</i>	
	1(a)	1(b)	2(a)	2(b)	3(a)	3(b)
<i>obesity</i>	-0.093 (.096)		-0.064 (.140)		-0.281 (.164)	
<i>dobese</i>		-.163 (.193)		-.111 (.225)		-.149 (.256)
<i>dthin</i>		-.059 (.273)		-.192 (.360)		.143 (.255)
<i>beauty</i>	.130 (.131)	.121 (.132)	.250* (.134)	.241* (.136)	-.040 (.138)	-.087 (.169)
<i>age</i>	-.192*** (.076)	-.196*** (.077)	-.228*** (.076)	-.235*** (.080)	-.097 (.072)	-.120 (.149)
<i>age</i> ²	.002** (.001)	.002** (.001)	.002*** (.001)	.003*** (.001)	.001 (.001)	.001 (.002)
<i>wage</i>	-.000 (.0001)	.000 (.000)	-.0001 (.0001)	-.0002 (.0001)	.0004** (.0002)	-.000** (.0002)
<i>ambition</i>	.091 (.106)	.090 (.107)	-.031 (.123)	-.036 (.123)	.080 (.075)	.210 (.143)
<i>self-conf</i>	.045 (.095)	.050 (.099)	.189* (.110)	.196* (.116)	.119 (.076)	-0.147 (.124)
<i>constant</i>			2.959** (1.509)	2.951* (1.665)		
N	121	121	121	121	66	66
<i>Pr > chi2</i>	0.0020	0.0048	0.0000	0.0001	0.0005	0.0005

Note: Standard errors (adjusted for 27 clusters in interviewers) of parameter estimates in parentheses. Significance level are marked with * for $p \leq 0.10$, ** for $p \leq 0.05$, and *** for $p \leq 0.01$.

11.7. QUESTIONNAIRE Q1.



An experiment of the students of the course
ECONOMIC ANALYSIS OF COLLECTIVE RELATIONS
2007

QUESTIONNAIRE

Interviewer:

Profesor in charge: Pablo Brañas Garza

Assistant Profesor: Antonios Proestakis

PART 1

With the following questions you are going to describe your friends' physical characteristics and their personality. Please put the name list in front of you and check the number that describes better the level of the following characteristics for each one of your subjects:

Regarding their physical characteristics:

a) ugly :... 1... 2..... 3..... 4..... 5..... 6..... 7... handsome/beautiful

Subject 1:..... 1..... 2..... 3..... 4..... 5..... 6..... 7.....

Subject 2:..... 1..... 2..... 3..... 4..... 5..... 6..... 7.....

Subject 3:..... 1..... 2..... 3..... 4..... 5..... 6..... 7.....

Subject 4:..... 1..... 2..... 3..... 4..... 5..... 6..... 7.....

Subject 5:..... 1..... 2..... 3..... 4..... 5..... 6..... 7.....

Subject 6:..... 1..... 2..... 3..... 4..... 5..... 6..... 7.....

Subject 7:..... 1..... 2..... 3..... 4..... 5..... 6..... 7.....

Subject 8:..... 1..... 2..... 3..... 4..... 5..... 6..... 7.....

Subject 9:..... 1..... 2..... 3..... 4..... 5..... 6..... 7.....

Subject 10:..... 1..... 2..... 3..... 4..... 5..... 6..... 7.....

b) thin :... 1... 2..... 3..... 4..... 5..... 6..... 7... obese

Subject 1:..... 1..... 2..... 3..... 4..... 5..... 6..... 7.....

∴

Subject 10 :..... 1..... 2..... 3..... 4..... 5..... 6..... 7.....

11.7. QUESTIONNAIRE Q1.

c) badly dressed :... 1... 2... 3... 4... 5... 6... 7... well-dressed

Subject 1:..... 1..... 2..... 3..... 4..... 5..... 6..... 7.....

∴

Subject 10 :..... 1..... 2..... 3..... 4..... 5..... 6..... 7.....

d) short :... 1... 2... 3... 4... 5... 6... 7... tall

Subject 1:..... 1..... 2..... 3..... 4..... 5..... 6..... 7.....

∴

Subject 10 :..... 1..... 2..... 3..... 4..... 5..... 6..... 7.....

Regarding their personality:

e) shy :... 1... 2... 3... 4 ... 5... 6 ... 7... leader

Subject 1:..... 1..... 2..... 3..... 4..... 5..... 6..... 7.....

. ∴

Subject 10 :..... 1..... 2..... 3..... 4..... 5..... 6..... 7.....

f) introverted :... 1... 2... 3... 4 ... 5... 6 ... 7... very social

Subject 1:..... 1..... 2..... 3..... 4..... 5..... 6..... 7.....

. ∴

Subject 10 :..... 1..... 2..... 3..... 4..... 5..... 6..... 7.....

g) anodyne :... 1... 2... 3... 4 ... 5... 6 ... 7... very creative

Subject 1:..... 1..... 2..... 3..... 4..... 5..... 6..... 7.....

. ∴

Subject 10 :..... 1..... 2..... 3..... 4..... 5..... 6..... 7.....

h) bad person :... 1... 2... 3... 4 ... 5... 6 ... 7... nice person

Subject 1:..... 1..... 2..... 3..... 4..... 5..... 6..... 7.....

. ∴

Subject 10 :..... 1..... 2..... 3..... 4..... 5..... 6..... 7.....

i) no ambitious :... 1... 2... 3... 4 ... 5... 6 ... 7... very ambitious

Subject 1:..... 1..... 2..... 3..... 4..... 5..... 6..... 7.....

. ∴

Subject 10 :..... 1..... 2..... 3..... 4..... 5..... 6..... 7.....

j) no self-confident :... 1... 2... 3... 4 ... 5... 6 ... 7... very self-confident

Subject 1:..... 1..... 2..... 3..... 4..... 5..... 6..... 7.....

. ∴

Subject 10 :..... 1..... 2..... 3..... 4..... 5..... 6..... 7.....

PART 2

Observe the following figures and answer the corresponded question

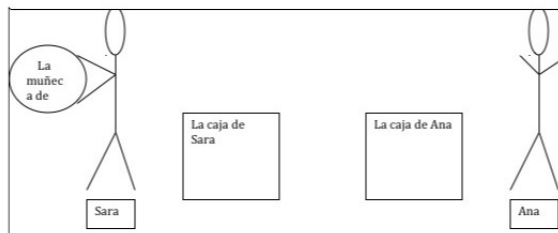

Image 1: Sara was playing with her doll when Anna arrived.

Image 2: Before Sara leave to school, she placed her doll between the two boxes.

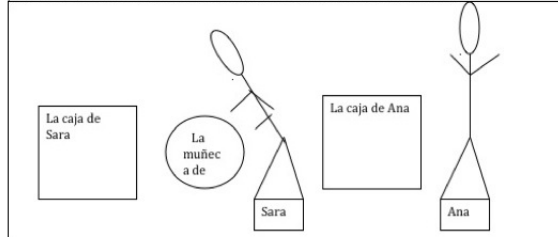
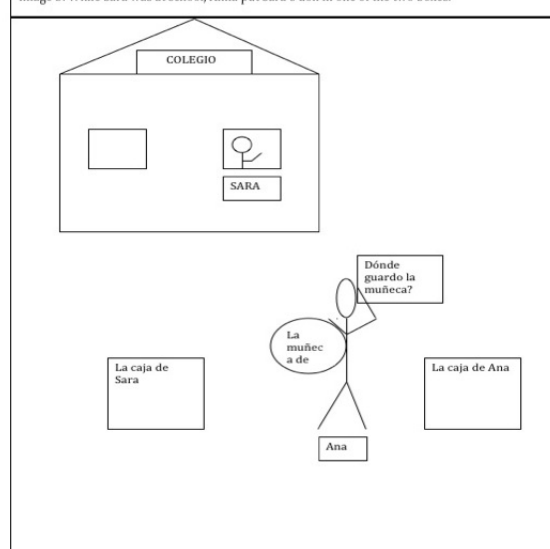
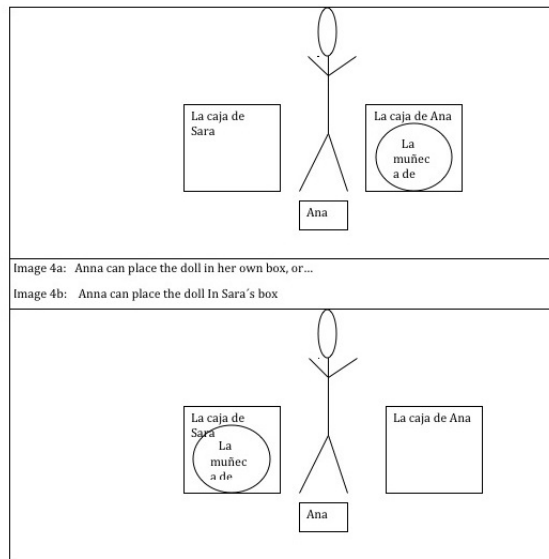

Image 3: While Sara was at school, Anna put Sara's doll in one of the two boxes.





Imagine that Sara is one (each time) of your subjects (Anna could be anyone else but one of the other subjects). Sara arrives back from school and she wants to play with her doll. Where is she going to look for it? Please mark the letter (a-k) that corresponds to the action that characterizes better your subjects behavior.

Subject 1 looks for the doll

...a...b...c...d...e...f...g...h...i...j...k...

. ∴

Subject 10 looks for the doll

...a...b...c...d...e...f...g...h...i...j...k...

11.7. QUESTIONNAIRE Q1.

- a) In her own box because she knows (100%, Anna's box 0%) that Anna has put it there.

- b) In her own box because she almost does not have any doubts (90%, Anna's box 10%) that Anna has put it there.

- c) In her own box because she is very sure (80%, Anna's box 20%) that Anna has put it there.

- d) In her own box because but she is not so sure (70%, Anna's box 30%) that Anna has put it there.

- e) In her own box because she thinks (60%, Anna's box 40%) that Anna has put it there.

- f) In any of the two boxes (50%, Anna's box 50%) since she does not know at all where Anna has put it.

- g) In Anna's box because she thinks (60%, Sara's box 40%) that Anna has place it there.

- h) In Anna's box because she is quite sure (70%, Sara's box 30%) that Anna has place it there.

- i) In Anna's box because she is very sure (80%, Sara's box 20%) that Anna has place it there.

- j) In Anna's box because she almost does not have any doubt (90%, Sara's box 10%) that Anna has place it there.

- k) In Anna's box because she knows (100%, Sara's box 0%) that Anna has place it there.

PART 3

Description of the relation with subjects.

a) What is your relation with each one of your subjects (brother, spouse, flatmate, partner, boyfriend, etc.) :

Subject 1:.....

.
∴

Subject 10 :.....

b) Mark the level that describes better your relation with each one of your subjects (independently of being friends or family), according to the following scale of relationship.

flat relationship: ... 1 ... 2 ... 3 ... 4 ... 5 ... 6 ... 7 ... close relationship

Subject 1:..... 1..... 2..... 3..... 4..... 5..... 6..... 7.....

.
∴

Subject 10 :..... 1..... 2..... 3..... 4..... 5..... 6..... 7.....

c) In the case that some of your subjects work, please fill in the following table:

Subject 1 works in and I think that he/she earns about

.
∴

Subject 1 works in and I think that he/she earns about

11.8. QUESTIONNAIRE Q2.



An experiment of the students of the course
ECONOMIC ANALYSIS OF COLLECTIVE RELATIONS
2007

QUESTIONNAIRE

Interviewee(subject's code, not the NAME):

Interviewer:

Profesor in charge: Pablo Brañas Garza

Assistant Profesor: Antonios Proestakis

PART 1

In the following questions you are asked to describe your physical characteristics and your personality. Please check the number that describes better the level of the following characteristics:

Regarding your physical characteristics, you consider yourself:

- a) ugly :... 1... 2... 3... 4... 5... 6... 7... handsome/beautiful
- b) thin :... 1... 2... 3... 4... 5... 6... 7... obese
- c) badly dressed :... 1... 2... 3... 4... 5... 6... 7... well-dressed
- d) short :... 1... 2... 3... 4... 5... 6... 7... tall

Regarding your personality, you consider yourself:

- e) shy :... 1... 2... 3... 4... 5... 6... 7... leader
- f) introverted :... 1... 2... 3... 4... 5... 6... 7... very social
- g) anodyne :... 1... 2... 3... 4... 5... 6... 7... very creative
- h) bad person :... 1... 2... 3... 4... 5... 6... 7... nice person
- i) no ambitious :... 1... 2... 3... 4... 5... 6... 7... very ambitious
- j) no self-confident :... 1... 2... 3... 4... 5... 6... 7... very self-confident

PART 2

Observe the following figures and answer the corresponded questions:

SAME PICTURES AS APPENDIX G

A. Imagine that Sara and Anna could be any person. Sara arrives back from school and she wants to play with her doll. Where is she going to look for it? Please mark the corresponded letter (a-k) (you must mark only one).

- a) In her own box because she knows (100%, Anna's box 0%) that Anna has put it there.
- b) In her own box because she almost does not have any doubt (90%, Anna's box 10%) that Anna has put it there.
- c) In her own box because she is very sure (80%, Anna's box 20%) that Anna has put it there.
- d) In her own box although she is not so sure (70%, Anna's box 30%) that Anna has put it there.
- e) In her own box because she thinks (60%, Anna's box 40%) that Anna has put it there.
- f) In any of the two boxes (50%, Anna's box 50%) since she does not know at all where Anna has put it.
- g) In Anna's box because she thinks (60%, Sara's box 40%) that Anna has place it there.
- h) In Anna's box because she is quite sure (70%, Sara's box 30%) that Anna has place it there.
- i) In Anna's box because she is very sure (80%, Sara's box 20%) that Anna has place it there.
- j) In Anna's box because she almost does not have any doubt (90%, Sara's box 10%) that Anna has place it there.
- k) In Anna's box because she knows (100%, Sara's box 0%) that Anna has place it there.

B. Imagine that YOU are Sara. Where are you going to look for your doll? Please mark the corresponded letter (1-v) (you must mark only one).

- a)** In my own box because I know (100%, Anna's box 0%) that Anna has put it there.
- b)** In my own box because I almost do not have any doubt (90%, Anna's box 10%) that Anna has put it there.
- c)** In my own box because I ma very sure (80%, Anna's box 20%) that Anna has put it there.
- d)** In my own box although I am not so sure (70%, Anna's box 30%) that Anna has put it there.
- e)** In my own box because I think (60%, Anna's box 40%) that Anna has put it there.
- f)** In any of the two boxes (50%, Anna's box 50%) since I do not know at all where Anna has put it.
- g)** In Anna's box because I think (60%, Sara's box 40%) that Anna has place it there.
- h)** In Anna's box because I am quite sure (70%, Sara's box 30%) that Anna has place it there.
- i)** In Anna's box because I am very sure (80%, Sara's box 20%) that Anna has place it there.
- j)** In Anna's box because I almost do not have any doubt (90%, Sara's box 10%) that Anna has place it there.
- k)** In Anna's box because I know(100%, Sara's box 0%) that Anna has place it there.

PART 3

At this moment, we would like to know the amount of money that you would like to request as a compensation for the effort you made to complete the questionnaire and for the information you provide us. The money disposed for this research project is given by the Spanish State. Do not forget that this money does not belong neither to us (neither affect us) nor to the Spanish State.

How much money would you like to receive for filling out this questionnaire?

I request the following amount of money: euros

In the attached stick we would like you to fill in your full name and address in order for us to send your money by mail. Obviously, this is optional, but in the case you want to receive your payment it is the only way. Please read the following compromise regarding data protection.

*****PAPER STICK HERE*****

Please, provide us with your phone number or e-mail address (or both), in order to contact you in about two weeks time for confirming the reception of the money sent.

E-mail:

According to the *Law of Data Protection*, the information provided in the previous pages is not going to be corresponded with your personal data. Finally, in Economics Faculty, there are constantly experiments organized. In these experiments, of various types (on-line, by mail, presence, etc) different types of people participate and of course money are earned depending on participants performance on the tasks. If you like it, we can include your personal data in our data base in order to inform you when you can earn some money. In order to be more operative and no annoying you for things that you are not interested in, we ask you to tell us from which amount of money you would be interested in participating.

- Are you interested in participating in one of these? YES.....NO.....
- In the case of being interesting, from which amount money would you willing to participate?.....
- If you had to come to the Faculty of Economics (Cartuja), would you do it? YESNO

Thank you very much for your effort and help, *Pablo Brañas Garza and Antonios Proestakis, University of Granada.*

APPENDICES OF ESSAY 2

12.1. APPENDIX 1 : TABLE OF AVERAGES AND BOX PLOTS.

Table 3: AVERAGE CONTRIBUTIONS						
<i>Treatment</i>	<i> contributions </i>			<i>%contributions</i>		
	all	end10	end20	all	end10	end20
<i>All sample</i> _(n=96)	5 (3.26)	4.22 (2.43)	5.72 (3.75)	.35 (.23)	.42 (.24)	.29 (.19)
<i>B1020</i> _(n=12)	6.25 (3.17)	5.33 (3.14)	7.17 (3.19)	.45 (.25)	.53 (.31)	.36 (.16)
<i>B10</i> _(n=4)	4.5 (1.3)	4.5 (1.3)		.45 (.13)	.45 (.13)	
<i>B20</i> _(n=8)	5.5 (3.12)		5.5 (3.12)	.28 (.16)		.28 (.16)
<i>RP10</i> _(n=12)	5.25 (5.36)	3.5 (2.07)	7 (7.18)	.35 (.28)	.35 (.21)	.35 (.36)
<i>RP20</i> _(n=12)	4.42 (2.31)	3.67 (1.63)	5.17 (2.79)	.31 (.16)	.37 (.16)	.26 (.14)
<i>RP1020</i> _(n=24)	4.71 (2.60)	4.67 (3)	4.75 (2.26)	.35 (.25)	.47 (.30)	.24 (.11)
<i>DP10</i> _(n=12)	5.17 (4.13)	4.33 (2.88)	6 (5.25)	.37 (.27)	.43 (.29)	.30 (.26)
<i>DP20</i> _(n=12)	4.33 (2.64)	3.17 (1.83)	5.5 (2.95)	.30 (.16)	.32 (.18)	.28 (.15)
	Standard errors in parenthesis.					

Figure 12.1.: Box Plot(1): Absolute Contributions

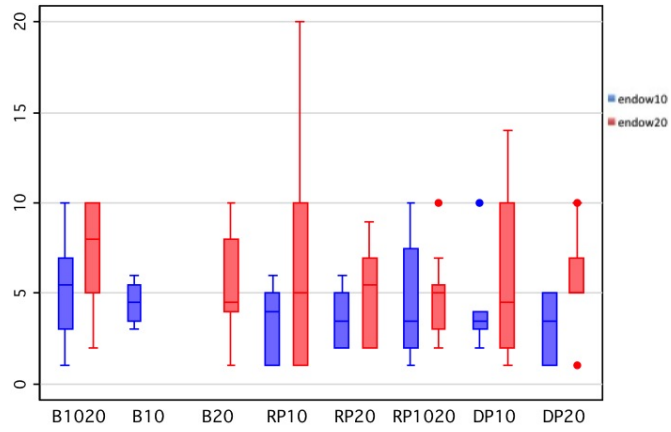
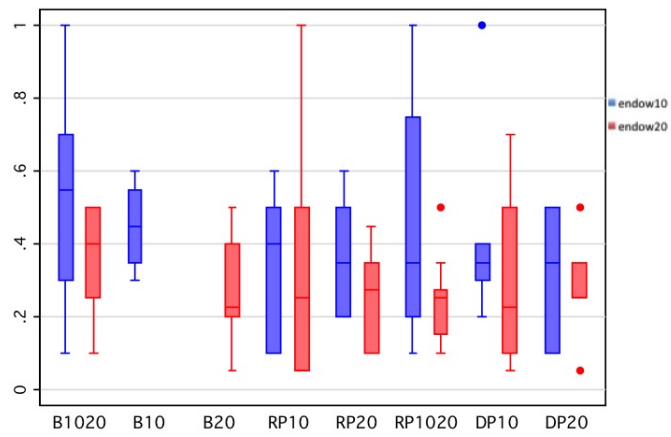

Figure 12.2.: Box Plot(2): Relative Contributions



12.2. APPENDIX 2: NO-CLUSTERED REGRESSIONS.

<i>Variable</i>	<i> contributions </i>		<i>%contributions</i>	
	1(a)	1(b)	2(a)	2(b)
<i>info</i>	-3.75** (1.8)	-3.93** (1.75)	-.22** (.10)	-.23** (.09)
<i>design</i>	.11 (1.35)	-.64 (1.32)	-.01 (.07)	-.02 (.07)
<i>hetero2</i>	3.30* (2.0)	3.94** 1.99	.18* (.11)	.21* .11
<i>hetero4</i>	4.41* (2.05)	5.09** 2.46	.26* (.13)	.29** .13
<i>endow20</i>	.63 (.97)	-1.49 (1.40)	-.15*** (.05)	-.23*** (.08)
<i>rich</i>	-.44 (.97)	-2.63* (1.42)	-.01 (.05)	-.09* (.08)
<i>rich20</i>		4.06** (1.98)		.16 (.11)
<i>constant</i>	5.13*** 1.92	6.35*** (1.97)	.46*** (.10)	.50*** (.11)
N	94	94	94	94
cens. obs.	10/4	10/4	10/4	10/4

* significant at 10%; ** significant at 5%; *** significant at 1%

12.2. APPENDIX 2: NO-CLUSTERED REGRESSIONS.

<i>Variable</i>	$ c - bs $	$\%(c - bs)$	$\%(c - bo)$
	3(a)	3(b)	3(c)
<i>info</i>	-4.59*** (1.71)	-.32*** (.11)	-.23*** (.11)
<i>design</i>	1.27 (1.28)	.76 (.08)	.04 (.08)
<i>hetero2</i>	5.05*** (1.94)	.32*** (.12)	-.12 .09
<i>hetero4</i>	6.84*** (2.41)	.47*** (.15)	
<i>endow20</i>	-4.51*** (1.36)	-.24*** (.08)	-.29*** (.10)
<i>rich</i>	-1.66 (1.39)	-.13 (.09)	-.04 (.10)
<i>rich20</i>	4.38** (1.92)	.27** (.12)	.13 (.14)
<i>constant</i>	.41 (1.94)	.08 (.12)	.28 (.20)
N	94	94	82

* significant at 10%; ** significant at 5%; *** significant at 1%

12.3. APPENDIX 3: BELIEFS ON RELATIVE CONTRIBUTIONS OF OTHER (SAME TYPE) SUBJECTS.

Figure 12.3.: Average Beliefs on %c of other (same type) subjects

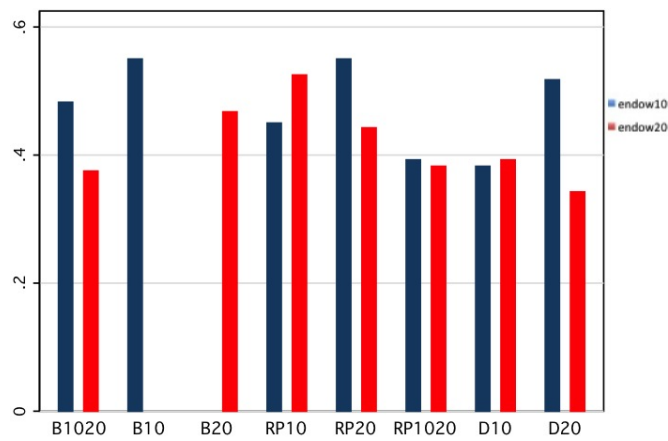
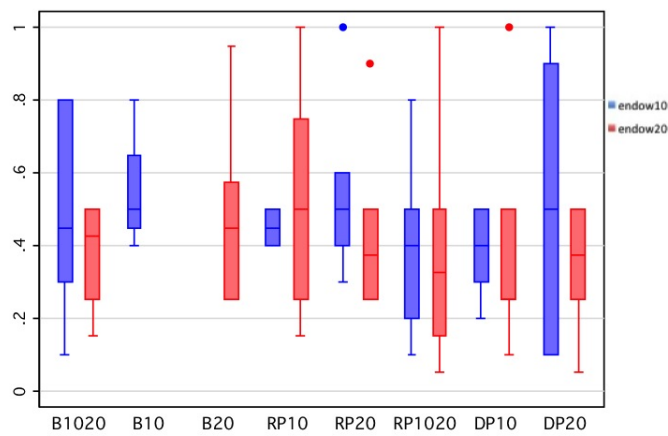

Figure 12.4.: Box Plot(3): Beliefs on %c of other (same type) subjects



12.3. APPENDIX 3: BELIEFS ON RELATIVE CONTRIBUTIONS OF OTHER (SAME TYPE) SUBJECTS.

Figure 12.5.: Mean of Actual %c - Beliefs on %c of other (same type) subjects

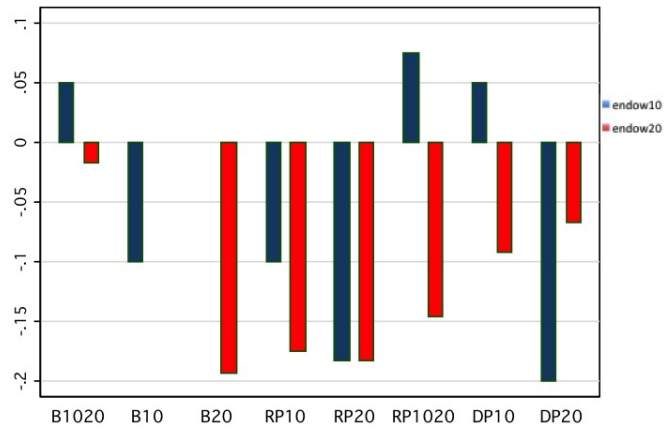

Figure 12.6.: Box Plot (4) Actual %c - Beliefs on %c of other (same type) subjects

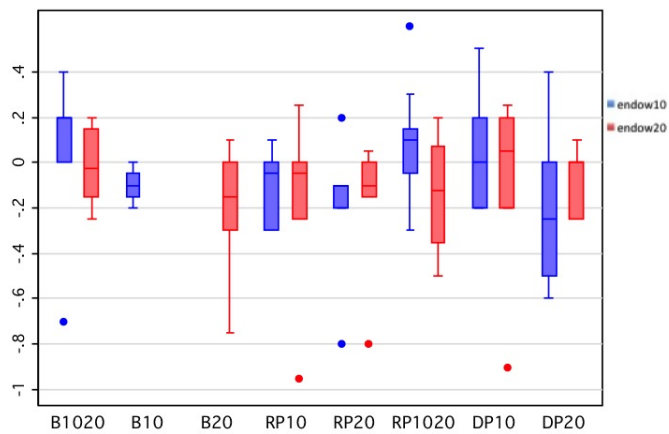
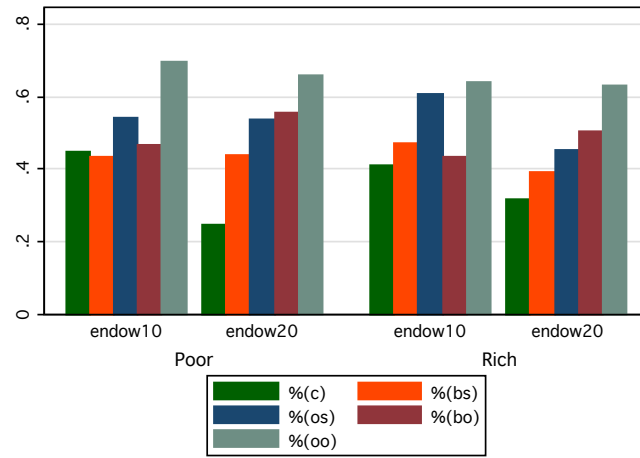

Figure 12.7.: Beliefs and Liabilities



APPENDICES OF ESSAY 3

13.1. PROOF OF LEMMA 1

Optimal punishing policy of inequity averse investors.

If the inequity averse investor receives a compensation $b \geq 1/2$, he will not punish the allocator. Effectively, the utility of punishing for this investor would be:

$$U_{1a}^p(b - z\lambda(1 - b), (1 - b) - \lambda(1 - b)) = b - z\lambda(1 - b) - \beta[b - z\lambda(1 - b) - ((1 - b) - \lambda(1 - b))] = (b - z\lambda(1 - b) - 2\beta b + \beta - \lambda\beta(1 - b)(1 - z)).$$

It can be observed that this expression is maximized when $\lambda = 0$.

Next, we assume that $0 \leq b < 1/2$.

Note that in this case this investor will punish the allocator provided that the unitary cost of punishing z is smaller than $\frac{\alpha}{1+\alpha}$, since $U_{1a}^p > U_{1a}^{np}$, where $U_{1a}^p(b - z\lambda(1 - b), (1 - b) - \lambda(1 - b)) = (b - z\lambda(1 - b)) - \alpha[(1 - b) - \lambda(1 - b) - (b - z\lambda(1 - b))] = (b(1 + 2\alpha) - \alpha + \lambda(z(1 + \alpha) - \alpha)(b - 1))$ (the utility of punishing by the inequity averse investor) and $U_{1a}^{np}(b, (1 - b) - b) = b - \alpha((1 - b) - b) = (b(1 + 2\alpha) - \alpha)$, (the utility of not punishing by the same investor).

We call $\bar{\lambda}$ the proportion of punishment that equals the payoff of both players after the punishment, that is, $(1 - b) - \bar{\lambda}(1 - b) = b - z\bar{\lambda}(1 - b)$. The value of $\bar{\lambda}$ is $\frac{1-2b}{(1-z)(1-b)}$.

If $\lambda > \bar{\lambda}$, the payoff of the allocator will be smaller than the payoff of the investor. To maximize his utility the inequity averse investor has to set λ as small as possible because this punishment generates advantageous inequality and this option is dominated by punishing until both players get the same payoff, that is, setting $\lambda = \bar{\lambda}$.

Note that, for instance, for $b = 0$, the optimal amount of punishment is $\bar{\lambda} = \frac{1}{1-z}$, but this is greater than 1. We assume that the maximal proportion of punishment is λ^* , with $\lambda^* \leq 1$. So, for these low offers the optimal punishment is the maximal one, λ^* . We equate $\frac{1-2b}{(1-z)(1-b)}$ to λ^* , in order to obtain the threshold reward that will trigger the maximal level of punishment λ^* . This level is $b^* = \frac{1-\lambda^*+\lambda^*z}{2-\lambda^*+\lambda^*z}$.

Summarizing, the optimal punishment policy of the averse investor is:

For $0 \leq b \leq b^* = \frac{1-\lambda^*+\lambda^*z}{2-\lambda^*+\lambda^*z}$, the optimal proportion of punishment will be $\lambda = \lambda^*$.

For $b^* < b < 1/2$, the optimal proportion of punishment will be $\lambda = \frac{1-2b}{(1-z)(1-b)} < \lambda^*$.

For $b \geq 1/2$, the inequity averse investor will not punish.

Optimal rewarding policy of a strongly inequity averse allocator.

If an inequity averse allocator offers a compensation of $b = 1/2$, her utility would be:

$$U_{2a}(1/2, 1/2) = 1/2.$$

If this allocator decides to offer a compensation of b to her investor, where $0 \leq b < 1/2$, her utility at most would be:

$$U_{2a}(b, (1-b)) = (1-b) - \beta((1-b) - b) = ((1-\beta) - b(1-2\beta)).$$

Therefore, as $\beta > 0.5$, to maximize this expression the allocator has to set b as big as possible, but it would be strictly smaller than $1/2$.

If the allocator decides to reward the investor with b , where $b > 1/2$, her utility would be $U_{2a}(b, (1-b)) = (1-b) - \alpha(b - (1-b)) = (1 + \alpha - b(1 + 2\alpha))$, that is strictly smaller than $1/2$.

Therefore, the optimal policy of strongly inequity allocators is to offer a reward of $b = 1/2$.

13.2. PROOF OF LEMMA 2

Optimal rewarding policy of selfish allocator when she is faced with a probability one with an inequity averse investor.

13.3. PROOF OF LEMMA 3.

If a selfish allocator offers half of the surplus 1, that is, offers a proportion $b = 1/2$, then her utility would be $1/2$ since this inequity averse investor will not punish her.

If the allocator decides to offer a smaller reward b , where $0 \leq b < 1/2$, her payoff would be strictly smaller. Let us check it. If the allocator offers a b such that $0 \leq b \leq b^* = \frac{1-\lambda^*+\lambda^*z}{2-\lambda^*+\lambda^*z}$, she knows that an inequity averse investor will punish her with the maximal intensity λ^* , and her utility will be $(1-b)(1-\lambda^*)$, that is smaller than $1/2$ since $\lambda^* > 1/2$.

On the other hand, if she decides to offer a return b , such that $b^* < b < 1/2$, the inequity averse investor will punish her choosing a $\lambda = \frac{1-2b}{(1-z)(1-b)}$, and thus, her payoff would be $U_{2e} = (1-b - \frac{1-2b}{(1-z)(1-b)})$, that is also smaller than $1/2$. Notice that this result holds for $z = 0$ and this utility is decreasing with z .

Therefore, the selfish allocator will offer $b = 1/2$ when she faces a inequity averse investor with probability one.

13.3. PROOF OF LEMMA 3.

Optimal rewarding policy of a selfish allocator with incomplete information.

The expected payoff of offering $0 \leq b < b^*$ is $\mu[(1-b)] + (1-\mu)[(1-b) - \lambda^*(1-b)] = (1-b)[(1-(1-\mu)\lambda^*)]$, given that the selfish investor does not punish and the averse investor applies the maximal punishment λ^* . It is easy to check that setting $b = 0$ dominates any other $b > 0$ whenever $b < b^*$. So, the expected payoff of offering $b = 0$ is $[1 - (1-\mu)\lambda^*]$.

On the other hand, offering $b = 1/2$, generates to the allocator a payoff of $1/2$, since none of the types of investors punishes her.

Then, for the allocator, offering $b = 0$ is better than offering $b = 1/2$ when $\mu > \frac{\lambda^*-1/2}{\lambda^*}$. And offering $b = 1/2$ is better than offering $b = 0$ when $\mu \leq \frac{\lambda^*-1/2}{\lambda^*}$.

Next, we have to prove that to offer $b = 0$ is better than to offer $b^* \leq b < 1/2$, when $\mu > \frac{\lambda^*-1/2}{\lambda^*}$.

The expected payoff of the selfish allocator of offering b , such that $b^* \leq b < 1/2$ is

$$\mu[(1-b)] + (1-\mu)[(1-b) - \lambda(1-b)] = \mu[(1-b)] + (1-\mu)[(1-b) - \frac{1-2b}{(1-z)(1-b)}(1-b)]$$

Assume that $\mu > \frac{\lambda^*-1/2}{\lambda^*}$. Then, we have to prove that $[1 - (1-\mu)\lambda^*] > \mu[(1-b)] + (1-\mu)[(1-b) - \frac{1-2b}{(1-z)(1-b)}(1-b)]$.

It is easy to verify that this expression holds for $\mu = 1$. It also holds for $\mu = \frac{\lambda^*-1/2}{\lambda^*}$.

As the function $(b - (1-\mu)\lambda^* + (1-\mu)\frac{1-2b}{(1-z)(1-b)}) > 0$ is monotonically increasing in μ , then this expression always holds. It can be verified that $b + (1-\mu)\frac{1-2b}{(1-z)(1-b)} > (1-\mu)\lambda^*$, since in the worst case, that is, when $\mu = \frac{\lambda^*-1/2}{\lambda^*}$, it holds. Therefore, it is shown that to offer $b = 0$ is better than to offer $b^* \leq b < 1/2$, when $\mu > \frac{\lambda^*-1/2}{\lambda^*}$.

Next, we have to prove that to offer $b = 1/2$ is better than to offer $b^* \leq b < 1/2$, when $\mu \leq \frac{\lambda^*-1/2}{\lambda^*}$. Then we have to prove that: $1/2 \geq \mu[(1-b)] + (1-\mu)[(1-b) - \frac{1-2b}{(1-z)(1-b)}(1-b)]$.

If we are in the worst case, that is $\mu = \frac{\lambda^*-1/2}{\lambda^*}$ and $b = 1/2$, this expression holds. Therefore, it is shown that to offer $b = 1/2$ is better than to offer $b^* \leq b < 1/2$, when $\mu \leq \frac{\lambda^*-1/2}{\lambda^*}$.

13.4. PROOF OF LEMMA 4.

FCE Equilibrium.

Given that $x < \widehat{x} = \frac{\lambda^*-1/2}{\lambda^*}$ and that both types of investors to invest (I), the updated probability remains the same as the prior, there is no updating of beliefs and the best option for both type of allocators is to offer $b = 1/2$. Every player gets a payoff of $1/2$ without any punishment. No type of investor has incentives to deviate, since $1/2 > 0$.

13.5. PROOF OF LEMMA 5.

QCE Equilibrium.

Given that $x > \widehat{x} = \frac{\lambda^*-1/2}{\lambda^*}$ and that both types of investors invest I , as there is no updating of beliefs, now the selfish allocator will offer $b = 0$. The inequity averse allocator will keep offering $b = 1/2$. On the other hand, given that $y \leq y''$, both the inequity averse investor and the selfish investor will choose to invest. The selfish player will not deviate because $(1-y)/2$

> 0 , since $y \leq y'' < \bar{y}$. On the other hand, the inequity averse investor does not deviate either, because $(1 - y)/2 + y(-z\lambda^* - \alpha[1 - \lambda^* + z\lambda^*]) \geq 0$ since $y \leq y''$.

13.6. PROOF OF LEMMA 6.

Inefficient Separating Equilibrium.

Suppose that the selfish investor (Ie) chooses I and the inequity averse investor (Ia) chooses N, then the updated beliefs of the allocators are $\mu(e/I) = 1$. Therefore the selfish allocator ($2e$) will offer $b = 0$ and the inequity averse allocator ($2a$) will offer $b = 1/2$.

The expected payoff of Ie will be $(1 - y)/2$ and the payoff of Ia would be 0.

Incentive compatibility for the selfish player implies that $(1 - y)/2 \geq 0$, that is, $y \leq 1 = \bar{y}$.

On the other hand, incentive compatibility for the inequity averse investor implies that

$(1 - y)/2 + y(-z\lambda^* - \alpha[1 - \lambda^* + z\lambda^*])$ has to be smaller than 0, and this is achieved if

$$y \geq \frac{1}{(1+2(z\lambda^*(1+\alpha)+\alpha(1-\lambda^*)))} = y''.$$

Note that there exist separating equilibria because $y'' \leq \bar{y}$.

Proof of lemma 7.

NC Equilibrium .

The selfish investor will deviate if $y < \bar{y}$, so since $y \geq \bar{y}$ player Ie does not deviate from choosing to invest. Player Ia does not deviate if $y \geq \bar{y}$, since $y \geq \bar{y} \geq y''$, this investor does not deviate either from not investing.

13.7. COMPUTING THE LEVELS OF CULTURAL INTOLERANCE

13.7.1. LEVELS OF CULTURAL INTOLERANCE IN QCE

The equilibrium payoff of the selfish investor is $(1 - y)/2$, for the inequity averse investor is $(1 - y)/2 + y(-z\lambda^* - \alpha(1 - \lambda^* + z\lambda^*))$, for the selfish allocator is $x + (1 - x)(1 - \lambda^*)$ and for the inequity averse allocator is $\frac{1}{2}$.

We start computing the levels of cultural intolerance of the selfish investors parents: (Quitar o poner subindices temporales a x e y)

$$V_{1e}^{ee} = (1 - y)/2$$

$$V_{1e}^{ea} = (1 - y)/2 - yz\lambda^*.$$

$$\text{Therefore, } \Delta V_{1e}^e(y) = yz\lambda^* > 0.$$

The same reasoning applies for inequity averse investors:

$$V_{1a}^{aa} = (1 - y)/2 + y(-z\lambda^* - \alpha(1 - \lambda^* + z\lambda^*)),$$

$$V_{1a}^{ae} = (1 - y)/2 - y\alpha.$$

$$\text{Therefore, } \Delta V_{1a}^a(y) = y\lambda^*(\alpha - z(1 + \alpha)) \geq 0.$$

$$\text{Then, we can compute: } \tau_1^{e*}(x_t, y_t) = q \cdot \Delta V_{1e}^e(y) \cdot (1 - x_t) = qy_t z \lambda^* (1 - x_t).$$

$$\text{And, } \tau_1^{a*}(x_t) = q \cdot \Delta V_{1a}^a(y) \cdot x_t = qy_t \lambda^* (\alpha - z(1 + \alpha)) x_t.$$

Now we proceed to analyze the socialization decision of the selfish allocators parents. In this case:

$$V_{2e}^{ee} = x + (1 - x)(1 - \lambda^*).$$

$$V_{2e}^{ea} = 1/2.$$

$$\text{Therefore, } \Delta V_{2e}^e(x) = 1/2 - (1 - x)\lambda^* \geq 0.$$

The same computation can be done for inequity averse allocators:

$$V_{2a}^{aa} = 1/2.$$

$$V_{2a}^{ae} = x(1 - \beta) + (1 - x)(1 - \lambda^* - \beta(1 - \lambda^* + z\lambda^*))$$

$$\text{Therefore, } \Delta V_{2a}^a(x) = 1/2 - [x(1 - \beta) + (1 - x)(1 - \lambda^* - \beta(1 - \lambda^* + z\lambda^*))] \geq 0.$$

$$\text{Thus we can obtain: } \tau_2^{e*}(y_t) = q \cdot \Delta V_{2e}^e(x) \cdot (1 - y_t) = q[1/2 - (1 - x_t)\lambda^*](1 - y_t).$$

$$\text{And } \tau_2^{a*}(y_t) = q \cdot \Delta V_{2a}^a(x) \cdot y_t = q[1/2 - [x_t(1 - \beta) + (1 - x_t)(1 - \lambda^* - \beta(1 - \lambda^* + z\lambda^*))]]y_t$$

13.7.2. LEVELS OF CULTURAL INTOLERANCE IN ISE

In this equilibrium the selfish investor chooses to to invest (I) and the inequity averse investor chooses not to invest (N) . The selfish allocator offers $b = 0$ and the inequity averse allocator offers $b = 1/2$. The equilibrium payoff of the selfish investor is $(1 - y)/2$, for the inequity

averse investor is 0, for the selfish allocator is x and for the inequity averse allocator is $x/2$.

We start computing the levels of cultural intolerance of the selfish investors parents:

$$V_{1e}^{ee} = (1 - y)/2$$

$$V_{1e}^{ea} = 0.$$

$$\text{Therefore } \Delta V_{1e}^e = (1 - y)/2 > 0.$$

With respect to inequity averse investors:

$$V_{1a}^{aa} = 0.$$

$$V_{1a}^{ae} = (1 - y)/2 - y\alpha.$$

$$\text{Therefore } \Delta V_{1a}^a = 0 - [(1 - y)/2 - y\alpha] = y\alpha - (1 - y)/2 > 0.$$

Note that to compute V_j^{ik} we assume that a parent of type i evaluates his child's well-being using his own utility function. For example, V^{ae} is the utility to an inequity averse player if his child is selfish. This child will not punish the allocator when he is offered $b = 0$.

We can now obtain the optimal education effort function for both types of investors:

$$\tau_1^{e*}(x_t, y_t) = q \cdot \Delta V_{1e}^e(x_t) \cdot (1 - x_t) = q(1 - y_t)/2(1 - x_t).$$

$$\tau_1^{a*}(x_t, y_t) = q \cdot \Delta V_{1a}^a(x_t) \cdot x_t = q(y_t\alpha - (1 - y_t)/2)x_t.$$

Now we proceed to analyze the socialization decision of the selfish allocators parents. In this case:

$$V_{2e}^{ee} = x.$$

$$V_{2e}^{ea} = x/2.$$

$$\text{Therefore } \Delta V_{2e}^e(x) = x/2 > 0.$$

The same for inequity averse allocators:

$$V_{2a}^{aa} = x/2.$$

$$V_{2a}^{ae} = x(1 - \beta).$$

$$\text{Therefore, } \Delta V_{2a}^a(x) = x/2 - x(1 - \beta) = x(\beta - 1/2) > 0.$$

$$\text{The same analysis as before gives place to: } \tau_2^{e*}(x_t, y_t) = q \cdot \Delta V_{2e}^e(x_t) \cdot (1 - y_t) = qx_t \frac{1}{2}(1 - y_t).$$

$$\text{And, } \tau_2^{a*}(x_t, y_t) = q \cdot \Delta V_{2a}^a(x_t) \cdot y_t = qx_t(\beta - 1/2)y_t.$$

13.7.3. PROOF OF THE STABILITY OF THE DYNAMIC SYSTEM IN ISE REGION.

We have a non-linear difference equation system. In order to check the stability of the system we can use a linear approximation to this system. As long as we analyze a small neighbourhood of the fixed points, the linear approximation can give us the same equilibrium as the original system, therefore the linear approximation (the local stability analysis) could serve as a supplement to the phase-diagram analysis.

The local stability or instability of the equilibrium can be deduced from the behavior of the matrix of partial derivatives- the Jacobian matrix of the nonlinear system- evaluated at the equilibrium .

We will denote the Jacobian evaluated at the equilibrium (\bar{x}, \bar{y}) by J_E and its elements by a, b, c, d :

$$J_E = \left[\begin{array}{cc} \frac{\partial \dot{x}_t}{\partial x} & \frac{\partial \dot{x}_t}{\partial y} \\ \frac{\partial \dot{y}_t}{\partial x} & \frac{\partial \dot{y}_t}{\partial y} \end{array} \right]_{(\bar{x}, \bar{y})} = \left[\begin{array}{cc} a & b \\ c & d \end{array} \right]$$

To check the stability of the dynamical systems we have to verify that the trace of J_E is negative, that is, $a + d < 0$ and that the determinant of J_E is positive, that is, $a \cdot d - b \cdot c > 0$, evaluated in the fixed points.

In region 3 the dynamics is governed by the equations:

$$\dot{x}_t = [x_t(1 - x_t)(1 - y_t)(\frac{1}{2} - \alpha y_t x_t)]$$

$$\dot{y}_t = x_t[y_t(1 - y_t)(\frac{1}{2} - \beta y_t)]$$

Therefore the Jacobian matrix J_E would be

$$\left[\begin{array}{cc} x_t y_t - \frac{1}{2} y_t - x_t + 3\alpha x_t^2 y_t - 2\alpha x_t y_t + \frac{1}{2} & \frac{1}{2} x_t^2 - \frac{1}{2} x_t - \alpha x_t^2 + \alpha x_t^3 \\ \frac{1}{2} y_t - \frac{1}{2} y_t^2 - \beta y_t^2 + \beta y_t^3 & \frac{1}{2} x_t - x_t y_t + 3\beta x_t y_t^2 - 2\beta x_t y_t \end{array} \right]$$

If we substitute the value of the fixed points $\bar{x} = \frac{\beta-1/2}{\alpha}$ and $\bar{y} = 1/2\beta$ in this matrix, we obtain

$$\left[\begin{array}{cc} -\frac{1}{8\alpha\beta} (2\beta - 1) (2\alpha - 2\beta + 1) & -\frac{1}{4\alpha^2}\beta (2\beta - 1) (2\alpha - 2\beta + 1) \\ 0 & -\frac{1}{8\alpha\beta} (2\beta - 1)^2 \end{array} \right]$$

Therefore the trace of the Jacobian evaluated in the equilibrium $(a + d)$, after simplifying

and rearranging terms is $-\frac{1}{4\beta}(2\beta - 1)$, this expression is negative if $\beta > 0.5$, therefore the trace is negative.

On the other hand, computing the determinant of the jacobian matrix, $a \cdot d - b \cdot c$ yields the result : $\frac{1}{64\alpha^2\beta^2}(2\beta - 1)^3(2\alpha - 2\beta + 1)$, expression that is positive, since $\alpha > \beta$. Therefore, the dynamical system is locally stable.

13.7.4. PROOF OF THE STABILITY OF THE DYNAMIC SYSTEM IN QCE REGION.

In region 4 the dynamics is governed by the equations:

$$\begin{aligned}\dot{x}_t &= x_t(1 - x_t)(y_t z \lambda^*(1 - x_t) - y_t \lambda^*(\alpha - z(1 + \alpha))x_t) \\ \dot{y}_t &= y_t(1 - y_t)((1/2 - (1 - x_t)\lambda^*)(1 - y_t) - ((1/2 - (x_t(1 - \beta) + (1 - x_t)(1 - \lambda^* - \beta(1 - \lambda^* + z\lambda^*)))y_t)].\end{aligned}$$

Therefore the Jacobian matrix J_E would be

$$\begin{bmatrix} y_t \lambda^* \begin{pmatrix} z - 2zx_t - 2\alpha x_t + \\ 3\alpha x_t^2 + 2z\alpha x_t - 3z\alpha x_t^2 \end{pmatrix} & -x_t \lambda^* (x_t - 1)(z - \alpha x_t + z\alpha x_t) \\ -y_t \lambda^* (y_t - 1)(z\beta y_t - \beta y_t + 1) & y_t - \lambda^* - \frac{3}{2}y_t^2 - 2\beta y_t + x_t \lambda^* + 2y_t \lambda^* + 3\beta y_t^2 + \\ & 2\beta y_t \lambda^* - 2x_t y_t \lambda^* - 3\beta y_t^2 \lambda^* - 2z\beta y_t \lambda^* - \\ & 2\beta x_t y_t \lambda^* + 3z\beta y_t^2 \lambda^* + 3\beta x_t y_t^2 \lambda^* + \\ & 2z\beta x_t y_t \lambda^* - 3z\beta x_t y_t^2 \lambda^* \end{bmatrix}$$

If we substitute the value of the fixed points $x' = \frac{z}{\alpha(1-z)}$ and $y' = \frac{1/2 - (\frac{\alpha(1-z)-z}{\alpha(1-z)})\lambda^*}{\beta(1 - \frac{\lambda^*(\alpha(1-z)-z)}{\alpha})}$ in this matrix, we obtain similar conclusions to the previous section that is, the trace of the Jacobian evaluated in the equilibrium is negative and the determinant of the jacobian matrix is positive, thus the dynamical system is locally stable.

The function $\lambda_x^*(z)$

If we equate $x'(z, \alpha) = \widehat{x}(\lambda^*)$, we can obtain $\lambda_x^*(z, \alpha) = \frac{\alpha(1-z)}{2(\alpha(1-z)-z)}$.

This function is increasing in z , $\frac{\partial \lambda_x^*}{\partial z} > 0$ for all z and decreasing in α , $\frac{\partial \lambda_x^*}{\partial \alpha} < 0$, for all α .

If $z = 0$ then $\lambda^* = 0.5$ for all α .

Denote by $z(\lambda_x^* = 1)$ the corresponding value of z if $\lambda_x^* = 1$; then $z(\lambda_x^* = 1) = \frac{\alpha}{2+\alpha} < \frac{\alpha}{1+\alpha} = \bar{z}$ for all α .

The function $\lambda_y^*(z)$.

If we equate $y'(\lambda^*, z, \alpha) = y''(\lambda^*, z, \alpha)$, we can obtain an implicit function $\lambda_y^*(z, \alpha)$.

This function is increasing in z , $\frac{\partial \lambda_y^*}{\partial z} > 0$ for all z .

For $z = 0$ $\lambda_y^*(0, \alpha) \leq 1/2$ for all α , the point which intersects with the ordinates axis ($z = 0$) is increasing with α , and when α tends to infinity, the intersection tends to $1/2$.

For $\lambda^* = 1$, then $\bar{z} = \frac{\alpha}{1+\alpha} > z(\lambda_y^* = 1) > z(\lambda_x^* = 1) = \frac{\alpha}{2+\alpha}$.

Proof that $\bar{\lambda}^*$ tends to $1/2$ when β tends to $1/2$.

Recall that $\widehat{x} \geq \bar{x}$ if and only if $\lambda^* \geq \bar{\lambda}^* = \frac{\alpha}{2(\alpha - \beta + 0.5)}$, assume that $\beta = 0.5 + \varepsilon$ for $\varepsilon > 0$ very small, then for $\beta = 0.5 + \varepsilon$, $\bar{\lambda}^* = \frac{\alpha}{2\alpha - \varepsilon}$, where ε tends to zero, then $\bar{\lambda}^*$ tends to 0.5 .

Suppose the smallest $\alpha = 0.5 + \varepsilon$, then $\bar{\lambda}^* = \frac{1}{(2 - \frac{\varepsilon}{\varepsilon + 0.5})} = 0.5 + \frac{\varepsilon}{2(\varepsilon + 1)}$, then for any $\alpha > 0.5 + \varepsilon$, $\bar{\lambda}^*$ would be at a distance smaller than $\frac{\varepsilon}{2(\varepsilon + 1)}$ from 0.5 .

Summarizing, if we have a $\beta > 0.5$ but a distance smaller than ε , then $\bar{\lambda}^*$ is at a distance smaller than $\frac{\varepsilon}{2(\varepsilon + 1)}$ from 0.5 .

APPENDIX OF CONCLUSION

The sequence of actions taken by A'_1 player follows. Actions are divided into three 4-period stages, titled after the corresponding implemented or elected λ .

Exogenous $\lambda = 1$.

Stage M'_{11} : A'_1 receives oblique message regarding the average investment and punishment of the previous generation playing TGP with $\lambda = 1$ (The average of the (9) actions of players $A_1, - A_6$.)

Stage M'_{12} : A'_1 receives vertical message (if any) from his/her corresponded predecessor (A_1) for TGP with $\lambda = 1$.

Stage $T'_{11}-T'_{13}$: A'_1 plays TGP with $\lambda = 1$ with B'_1, B'_2 and B'_3 respectively.

Stage C'_1 : A'_1 is informed about the average investment and punishment of his/her own neighborhood ($A'_1 - A'_6$), the cost of advising and the recuperation mechanism.

Stage AD'_1 : A'_1 decides whether he wants and which advice to send to his corresponded successor A''_1 .

Exogenous $\lambda = 0.4$.

Stage M'_{21} : A_1 receives oblique message regarding the average investment and punishment of the previous generation playing TGP with $\lambda = 0.4$. (The average of the (9) actions of players $A_1, - A_6$.)

Stage M'_{22} : A_1 receives vertical message (if any) from his/her corresponded predecessor (A_1) for TGP with $\lambda = 0.4$.

Stage $T'_{21}-T'_{23}$: A_1 plays TGP with $\lambda = 0.4$ with B'_4 , B'_5 and B'_6 respectively.

Stage C'_2 : A'_1 is informed about the average investment and punishment of his/her own generation ($A'_1-A'_6$), the cost of advising and the recuperation mechanism.

Stage AD'_2 : A'_1 decides whether he wants and which advice to send to his corresponded successor A''_1 .

Endogenous λ .

Stage M'_{31} : A'_1 receives oblique message regarding the voting.(The average of the (9) actions of players $A_1, - A_6$.)

Stage M'_{32} : A'_1 receives vertical message (if any) from his/her corresponded predecessor for voting

Stage $T'_{31}-T'_{33}$: A'_1 plays TGP with the endogenously determined λ with three randomly chosen players B' .

Stage C'_3 : A'_1 is informed about the average voting, the cost of advising and the recuperation mechanism.

Stage AD_3 : A_1 decides whether he wants and which advice to send to his corresponded successor A''_1 .

LIST OF FIGURES

LIST OF FIGURES

2.1. Diagram 1:Questionnaires	24
2.2. Average Money Requests by Obesity Level	31
2.3. Average Money Requests by Beauty Level	32
2.4. Money Requests by Gender	33
2.5. Average Money Requests by Obesity Level and Gender	38
2.6. Subjects' reports compared to Monitors' reports	43
2.7. Money Requests by Obesity Misestimation	43
3.1. Absolute Contributions	54
3.2. Relative Contributions	55
3.3. Mean of Beliefs of Same and Other type Contributions	61
3.4. High-Endowment Subjects (endow20)	63
3.5. Low-Endowment Subjects (endow10)	64
4.1. Equilibrium Regions	85
4.2. Phase diagram in QCE region.	91
4.3. Phase diagram in ISE region.	93
4.4. Phase diagram for Proposition 2	95
4.5. Phase diagram for Proposition 3a and 3b	96
4.6. Phase diagram for Proposition 3c	97
4.7. Phase diagram for Proposition 4 and 5a	98
4.8. Phase diagram for Proposition 5b	99
4.9. Phase diagram for Proposition 5c	99

LIST OF FIGURES

4.10. The effect of λ^* increasing on $y'_t(x_t)$, \hat{x} and y''	103
4.11. Proposition R_2	105
4.12. Evolution of λ^* when selfish allocators are in the majority.	106
4.13. The effect of voting $\lambda^* = 1$ when $x_0 > \frac{1}{2}$	107
4.14. Proposition R_3	109
4.15. Proposition R_4	110
4.16. Proposition R_5	111
4.17. Proposition R_6	112
5.1. TA_{1-3} and TB_{4-6} decision tree	120
5.2. Two Generations Game	123
12.1. Box Plot(1): Absolute Contributions	173
12.2. Box Plot(2): Relative Contributions	173
12.3. Average Beliefs on %c of other (same type) subjects	176
12.4. Box Plot(3): Beliefs on %c of other (same type) subjects	176
12.5. Mean of Actual %c - Beliefs on %c of other (same type) subjects	177
12.6. Box Plot (4) Actual %c - Beliefs on %c of other (same type) subjects	177
12.7. Beliefs and Liabilities	178

TABLE OF CONTENTS

CONTENTS

Acknowledgements	i
Dedication	iii
Abstract	iii
Resumen	vii
Content	x
I. General Introduction	1
1. Introduction	2
1.1. General Idea	2
1.2. Obesity as a source of self-discrimination.	4
1.3. Wealth heterogeneity in public good games	7
1.4. A theoretical approach on the intergenerational transmission of trust.	10
II. Essays	15
2. Self-discrimination: A field experiment on obesity.	16
2.1. Introduction	17
2.2. Experimental Methods	22
2.2.1. Stage 1: Mediators' Training	23

2.2.2. Stage 2: Questionnaires and Implementation	23
2.2.3. Payments	25
2.3. Data Considerations	26
2.4. Results	30
2.4.1. Preliminary results	30
2.4.2. Regression Analysis	34
2.5. Discussion	41
3. Accounting for real wealth in heterogeneous-endowment public good games	46
3.1. Introduction	46
3.2. Literature Review	49
3.3. Experimental design and method	51
3.4. Results	54
3.4.1. Relative and Absolute Contributions	54
3.4.2. Beliefs on Contributions	59
3.5. Conclusions	66
4. Intergenerational Trust Transmission: The effect of Endogenous Punishment	68
4.1. Introduction:	68
4.2. The Trust Game with a Punishment Phase (TGP).	74
4.3. Social Preferences: Inequity Aversion.	76
4.3.1. Punishment policy of strongly inequity averse investors.	78
4.3.2. Rewarding policy of strongly inequity averse allocators.	78
4.3.3. Changes in the behaviour of selfish agents.	79
4.3.4. Rewarding policy of allocators with incomplete information	80
4.4. Equilibria of the Trust Game with Punishment (TGP).	81

4.5. The Socialization Process and the Education Effort by Parents in a Segmented Society.	84
4.5.1. Levels of Cultural Intolerance	88
4.6. Cultures in the long run.	93
4.6.1. Fully Cooperative Culture	94
4.6.2. Inefficient Separate Culture	98
4.6.3. Quasi Cooperative Culture	100
4.7. Re-considering Propositions when λ^* is endogenously determined.	101
4.7.1. Reconsidering Proposition 1	102
4.7.2. Reconsidering Proposition 2	103
4.7.3. Reconsidering Proposition 3	104
4.7.4. Reconsidering Proposition 4	109
4.7.5. Reconsidering Proposition 5	110
4.7.6. Reconsidering Proposition 6	112
4.8. Conclusion	113
III. General Conclusion	115
5. Conclusion	116
5.1. Methodological Approaches	116
5.2. Further Research: Experiments on Intergenerational Trust Transmission (ExITT)	117
5.2.1. One Generation Game	118
5.2.2. Inter-generation Trust Game with Punishment	120
5.3. Epilogue	123

IV. Resumen de los trabajos en Castellano	125
6. RESUMEN DE LOS TRES TRABAJOS EN CASTELLANO	126
6.1. Trabajo 1: Autodiscriminación: Un experimento de campo sobre obesidad.	126
6.2. Trabajo 2: El efecto de la renta real en experimentos de bienes públicos con dotaciones heterogeneas.	127
6.3. Trabajo 3: La transmisión Intergeneracionál de Confianza: El efecto del Castigo Endogeno	128
 V. Bibliography	 129
7. Bibliography of Introduction	130
8. Bibliography of Essay 1	132
9. Bibliography of Essay 2	137
10. Bibliography of Essay 3	140
 VI. Appendix	 145
11. Appendices of Essay 1	146
11.1. Detailed chronological description of the methodological process.	146
11.2. Nonparametric test analysis.	152
11.3. Spearman’s rank correlation coefficients	154
11.4. Interval and Tobit Regressions.	155
11.5. Adding control variables in Ordered Probit Regression 1(b).	156
11.6. Probit Regressions by Gender.	157
11.7. Questionnaire Q1.	159
11.8. Questionnaire Q2.	167

12. Appendices of Essay 2	172
12.1. Appendix 1 : Table of Averages and Box Plots.	172
12.2. Appendix 2: No-clustered Regressions.	174
12.3. Appendix 3: Beliefs on relative contributions of other (same type) subjects.	176
13. Appendices of Essay 3	179
13.1. Proof of lemma 1	179
13.2. Proof of lemma 2	180
13.3. Proof of lemma 3.	181
13.4. Proof of lemma 4.	182
13.5. Proof of lemma 5.	182
13.6. Proof of lemma 6.	183
13.7. Computing the levels of cultural intolerance	183
13.7.1. Levels of cultural intolerance in QCE	183
13.7.2. Levels of cultural intolerance in ISE	184
13.7.3. Proof of the stability of the dynamic system in ISE region.	186
13.7.4. Proof of the stability of the dynamic system in QCE region.	187
14. Appendix of Conclusion	189
List of figures	191
Table of contents	194