

MATERIALES DE CONSTRUCCIÓN.

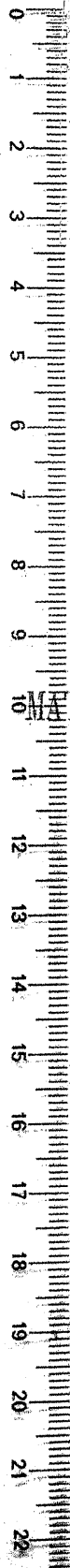

2 400 40



MADE IN SPAIN

3
MATERIALES DE CONSTRUCCIÓN.

MATERIALES
DE
CONSTRUCCIÓN,

POR
D. MANUEL PARDO,

INGENIERO JEFE DE PRIMERA CLASE DE CAMINOS, CANALES Y PUERTOS
Y PROFESOR DE LA ESCUELA.

Segunda edición, corregida y aumentada.

—
A T L A S .
—

MADRID.
IMPRESA Y FUNDICIÓN DE MANUEL TELLO,
IMPRESOR DE CÁMARA DE S. M.
Don Evaristo, S.
1891.

Esta obra es propiedad de su autor.

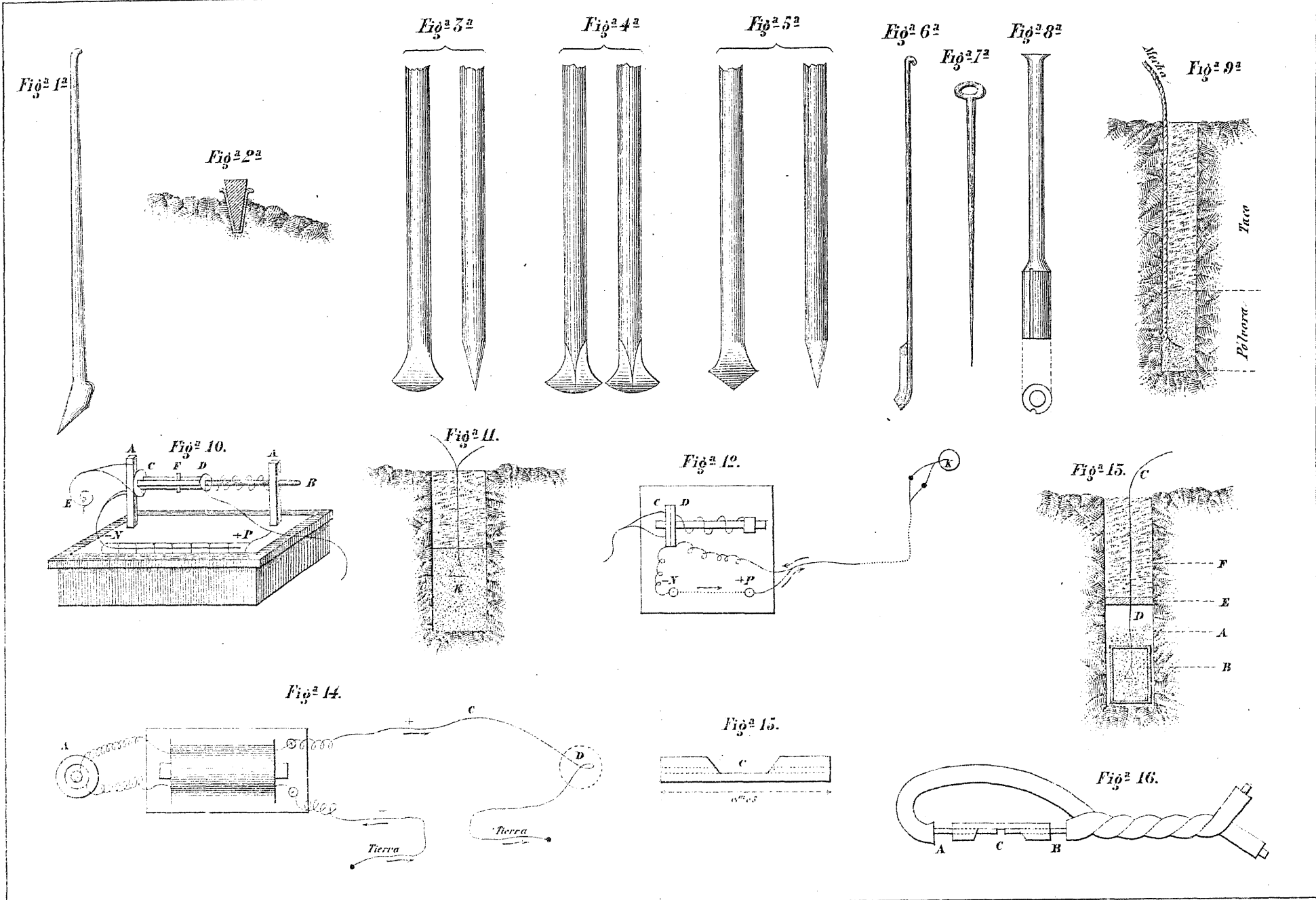

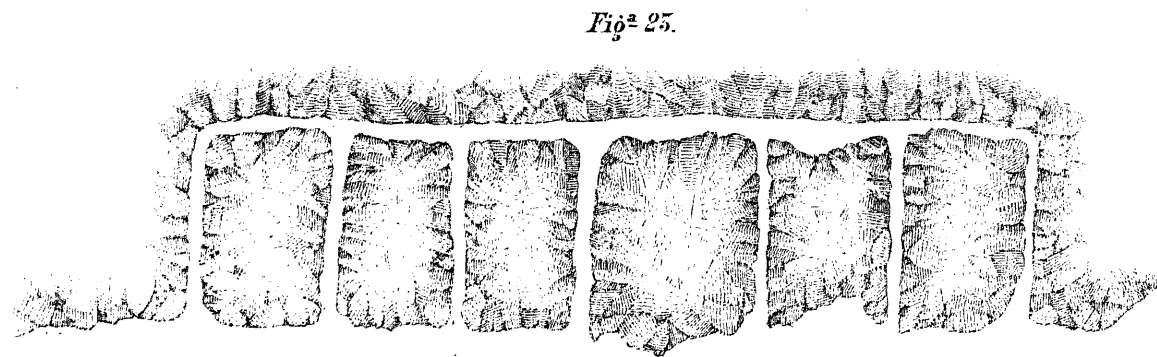
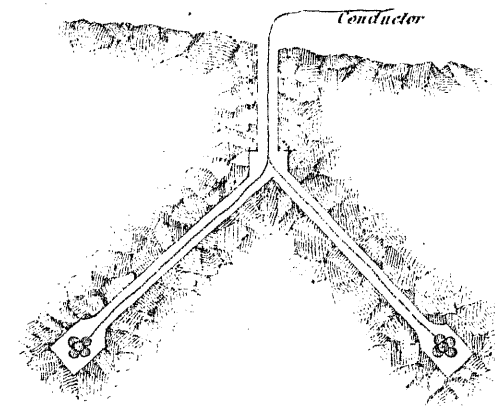
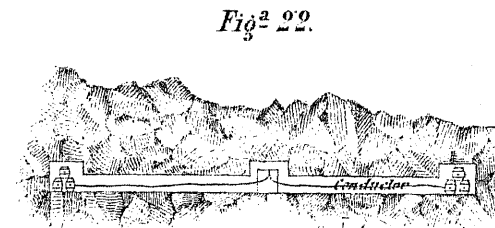
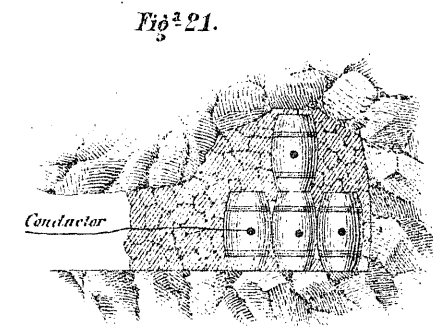
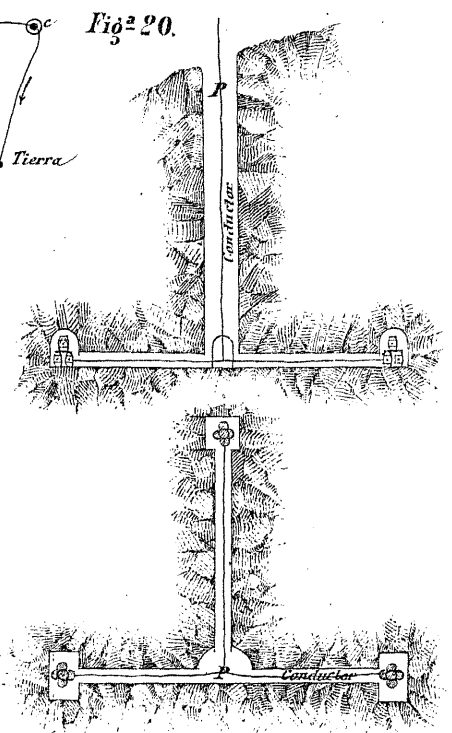
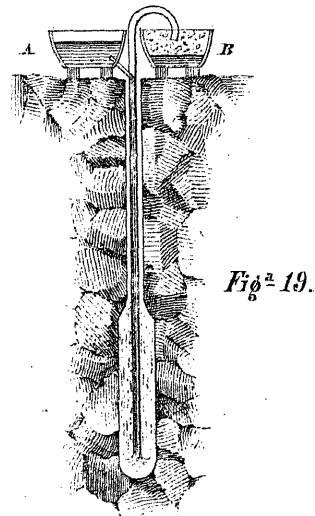
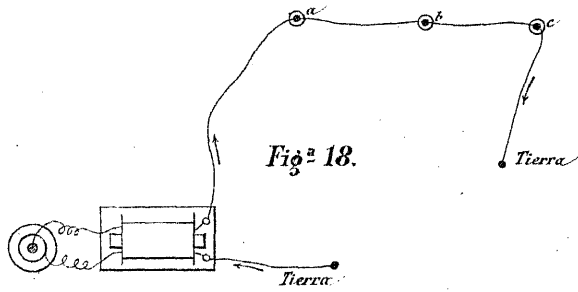
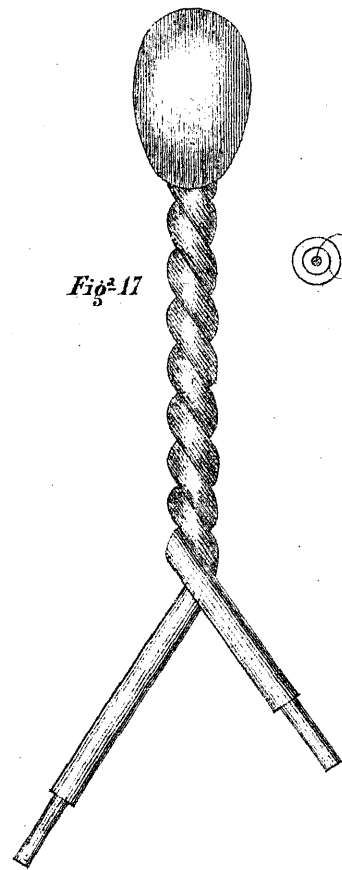

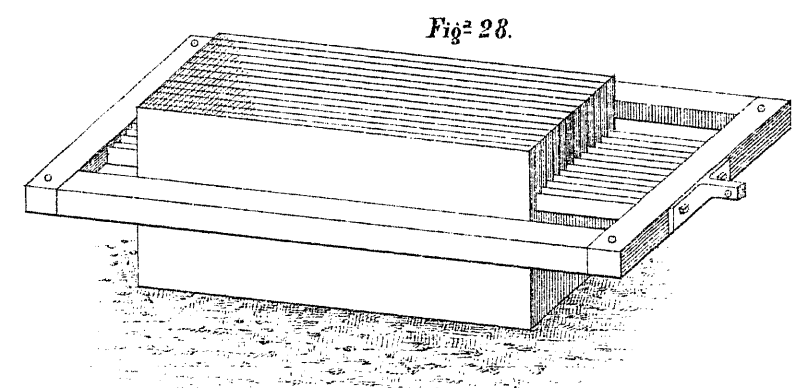
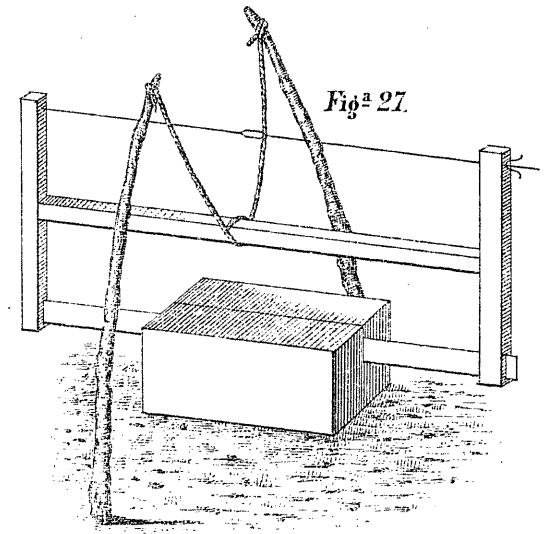
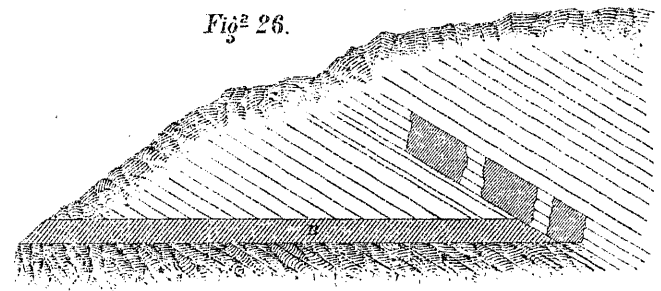
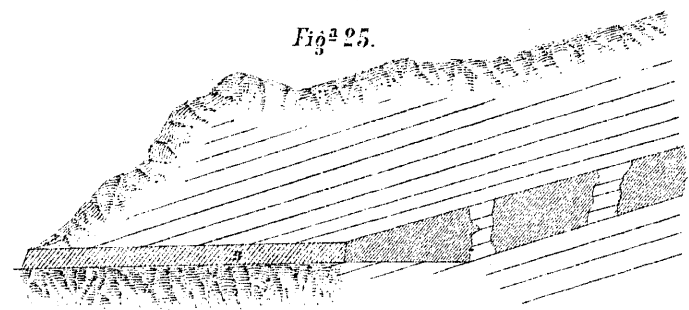
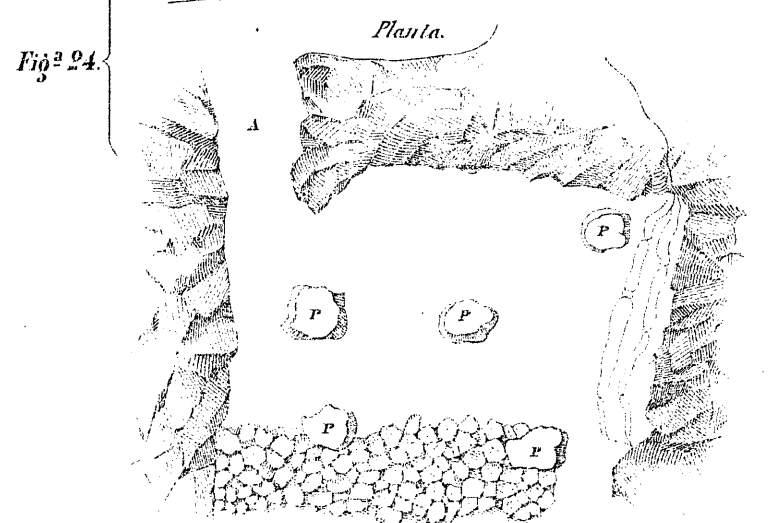
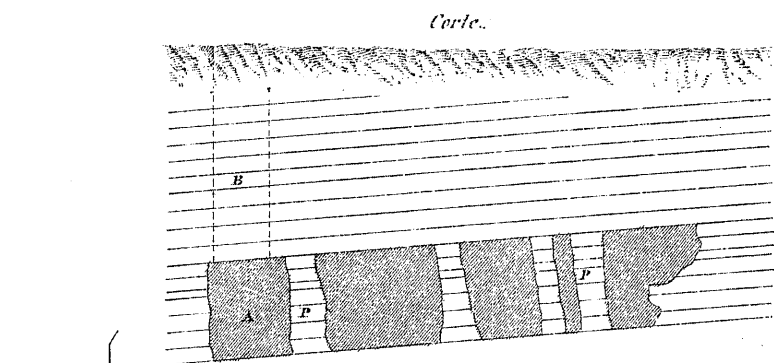

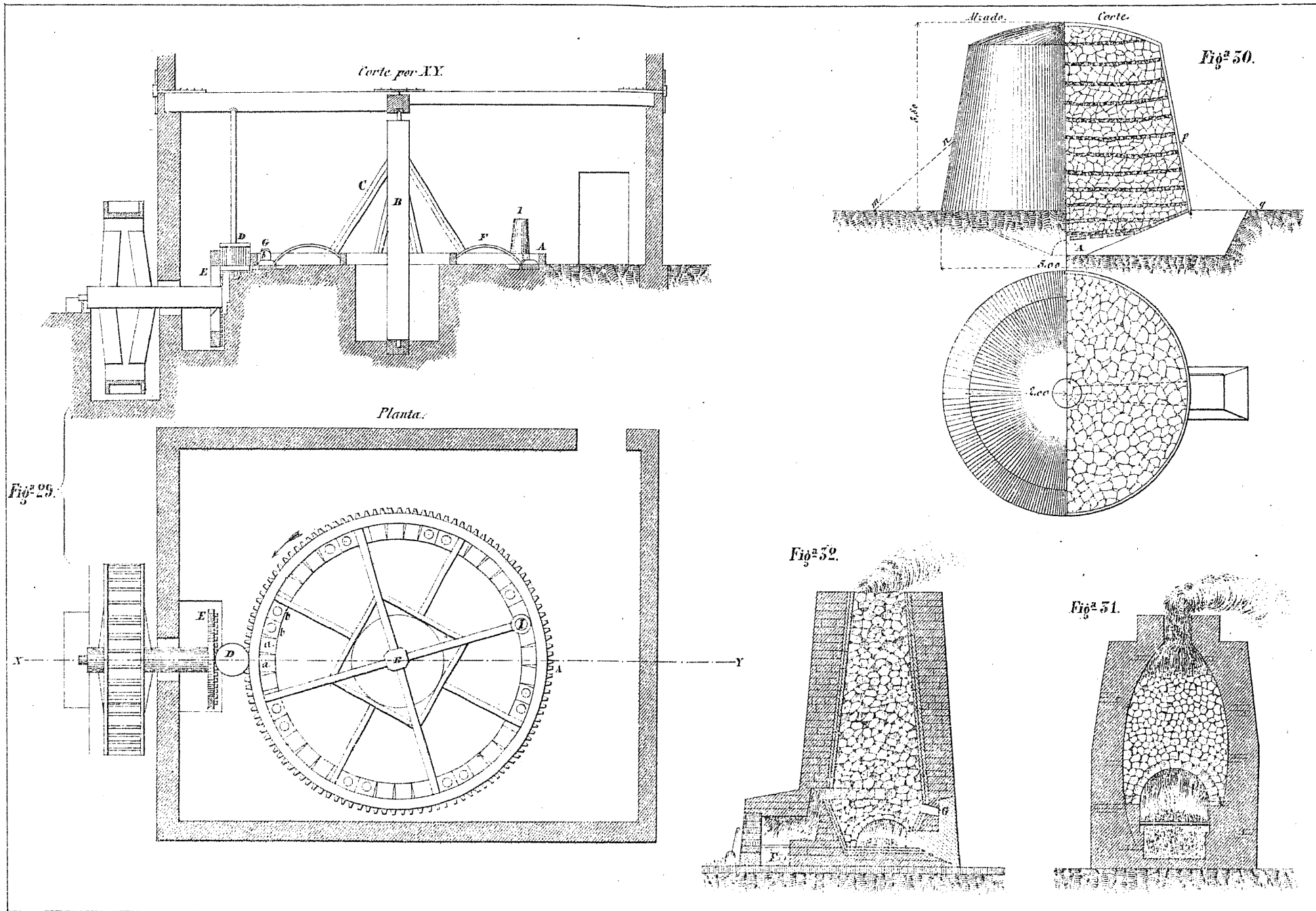

J. Navarro d^e

Lit. E. Fernandez Feijó & Madrid.

A. Corona g^o

Figª 55.

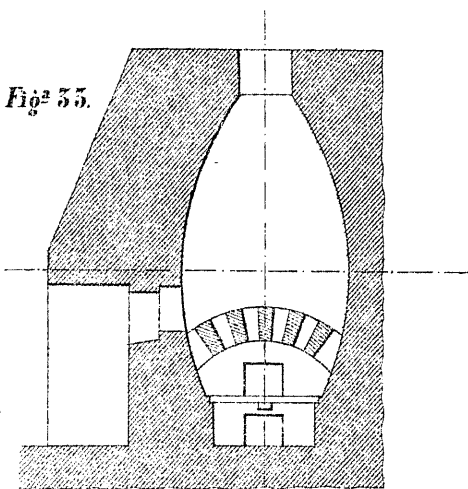

Figª 54.

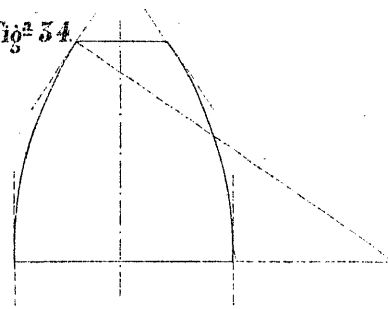

Figª 55.

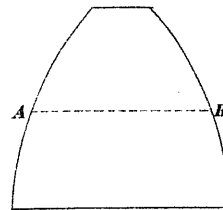

Figª 56.

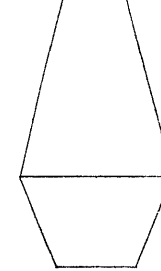

Corte por A.B.

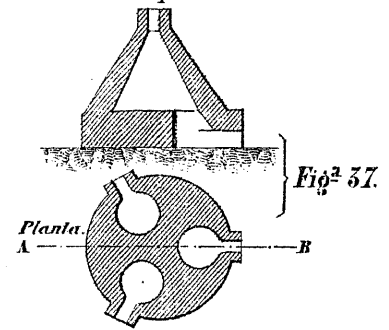

Figª 37.

Planta. A B

Detalle. A.

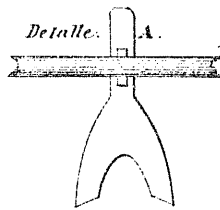

Figª 40.

Planta.

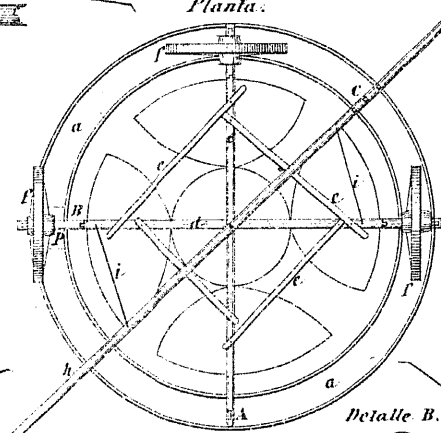

Detalle B.



Detalle C.

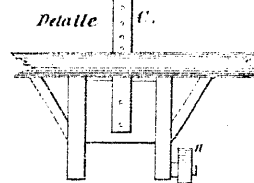

Corte.

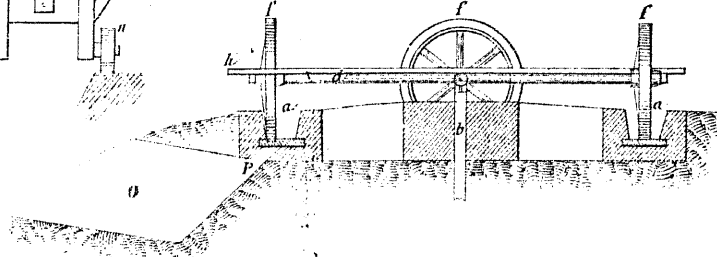

Figª 59.

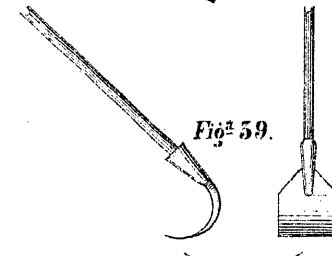

Figª 42.

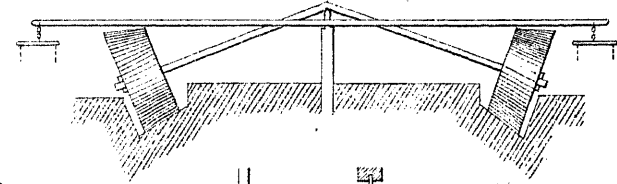

Figª 58.

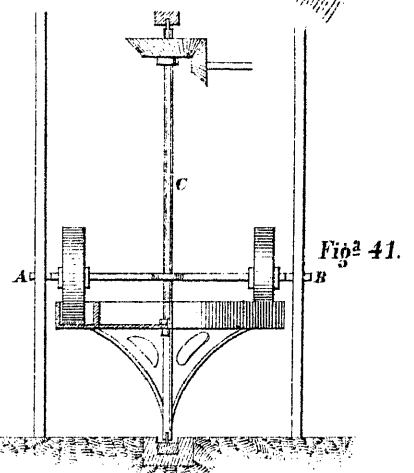
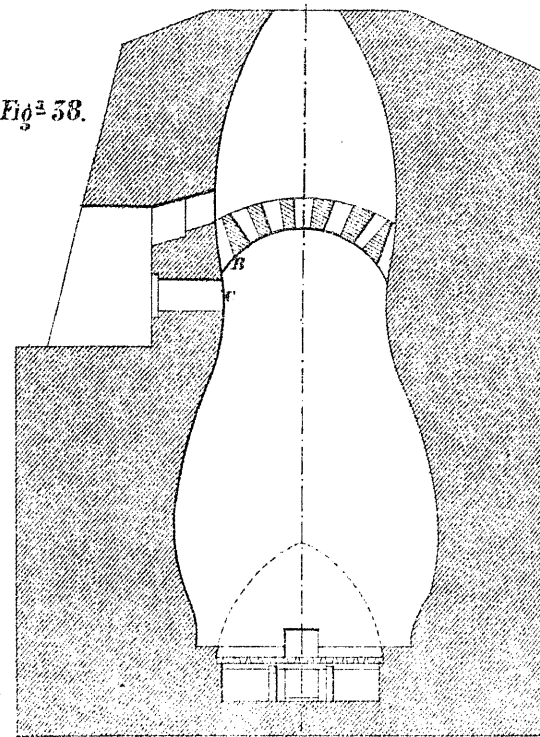

Figª 41.

J. Navarro dª

Lit. E. Fernandez, Fajó & Madrid.

A. Corona gª

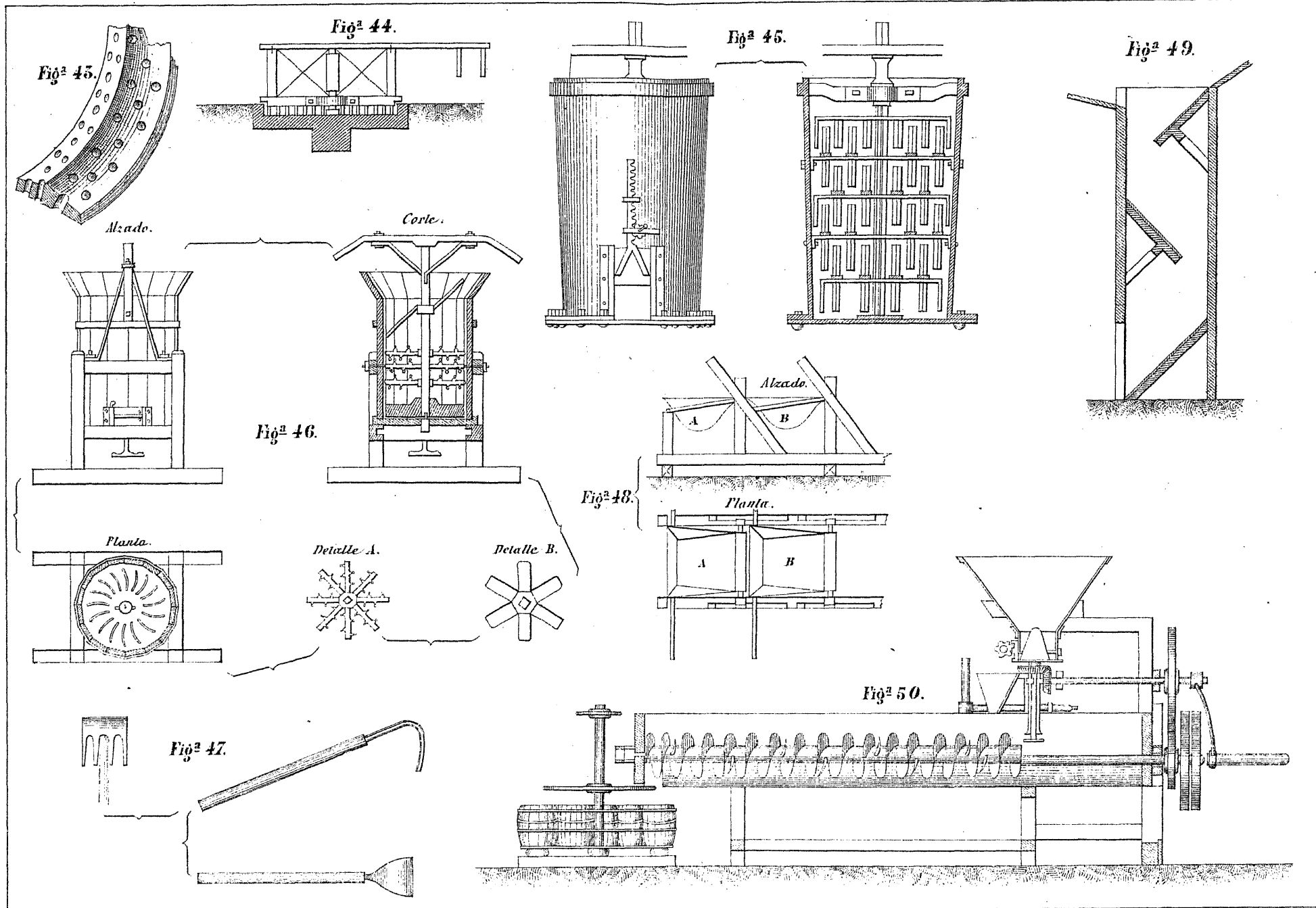

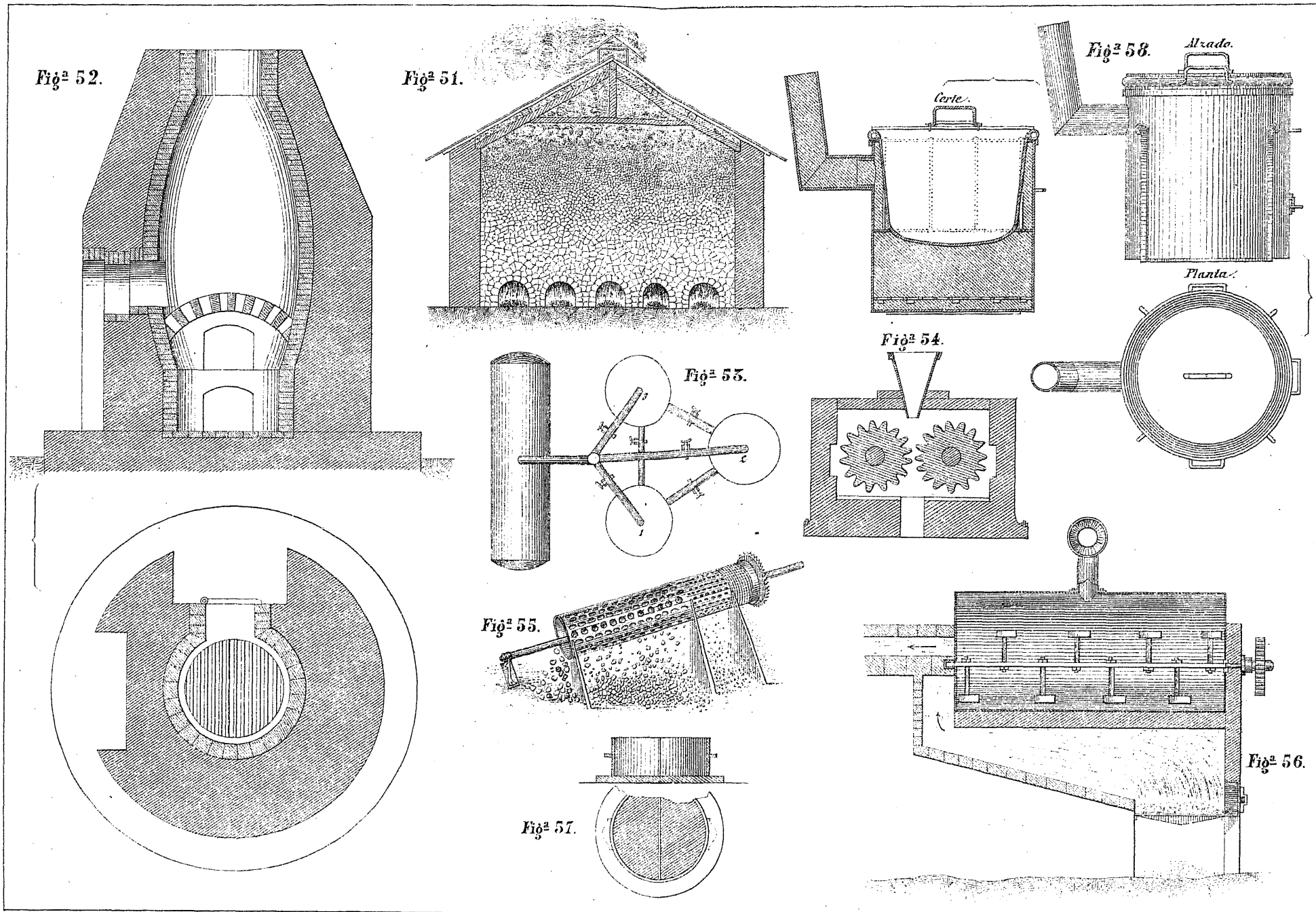

J. Navarro d^o

Lit. E. Fernandez, Fejoé & Madrid.

A. Corona g^o

Figª 59.

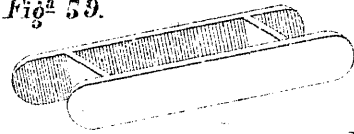

Figª 60.

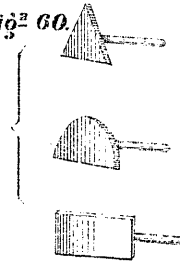

Figª 61.

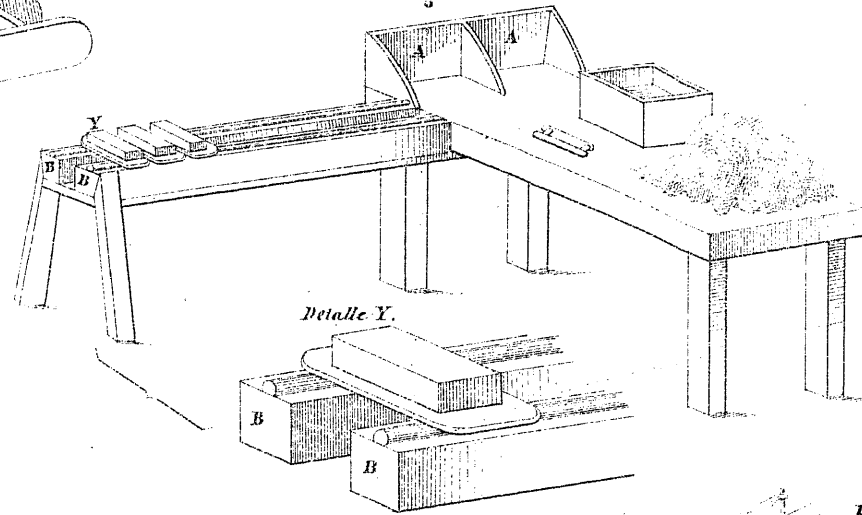

Figª 62.

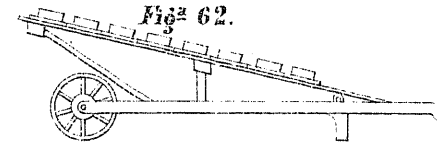

Figª 63.

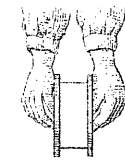

Figª 64.

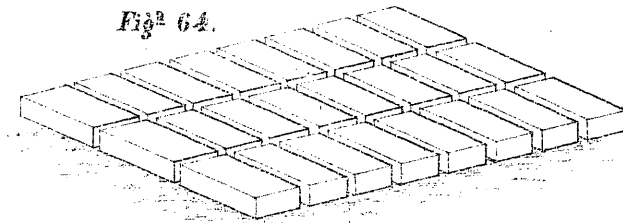

Figª 67.

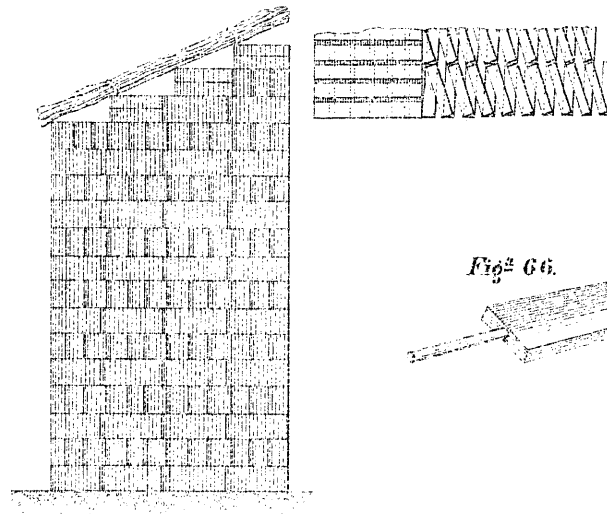

Figª 69.

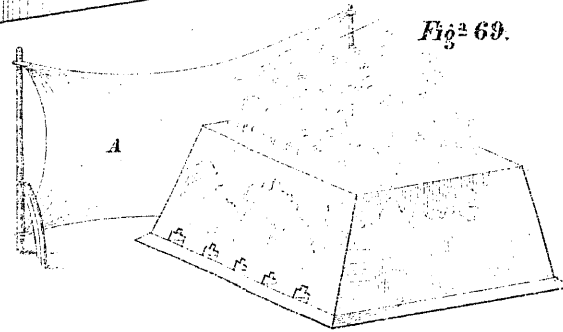

Figª 65.

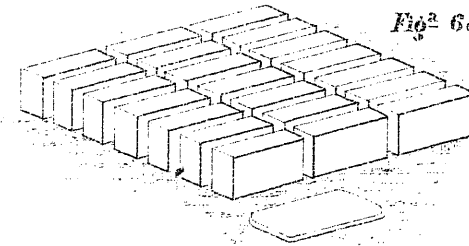

Figª 66.



Figª 68.

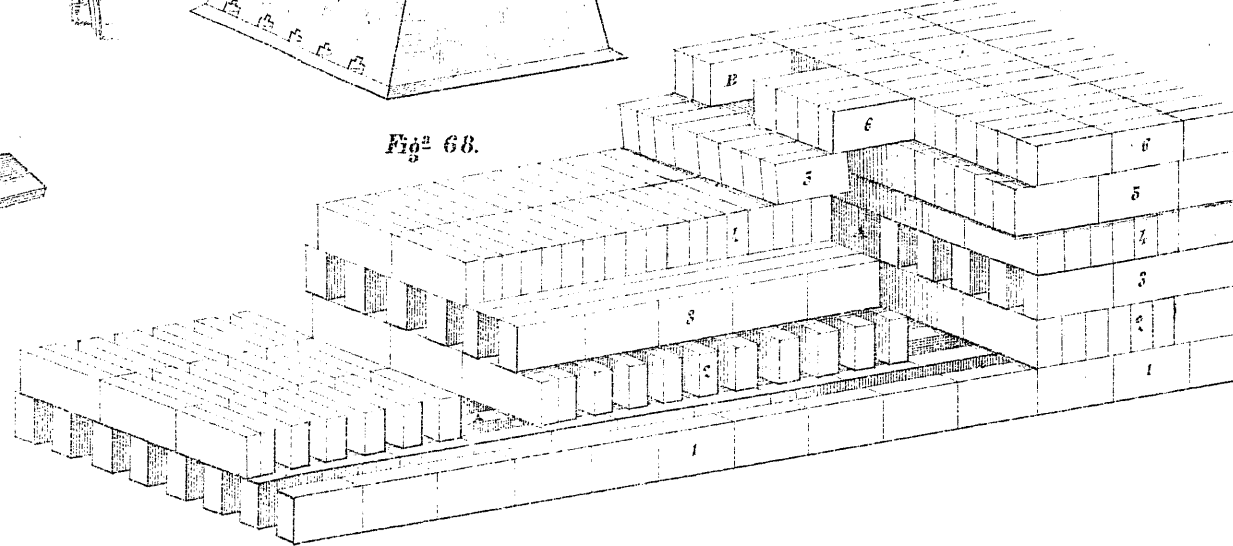

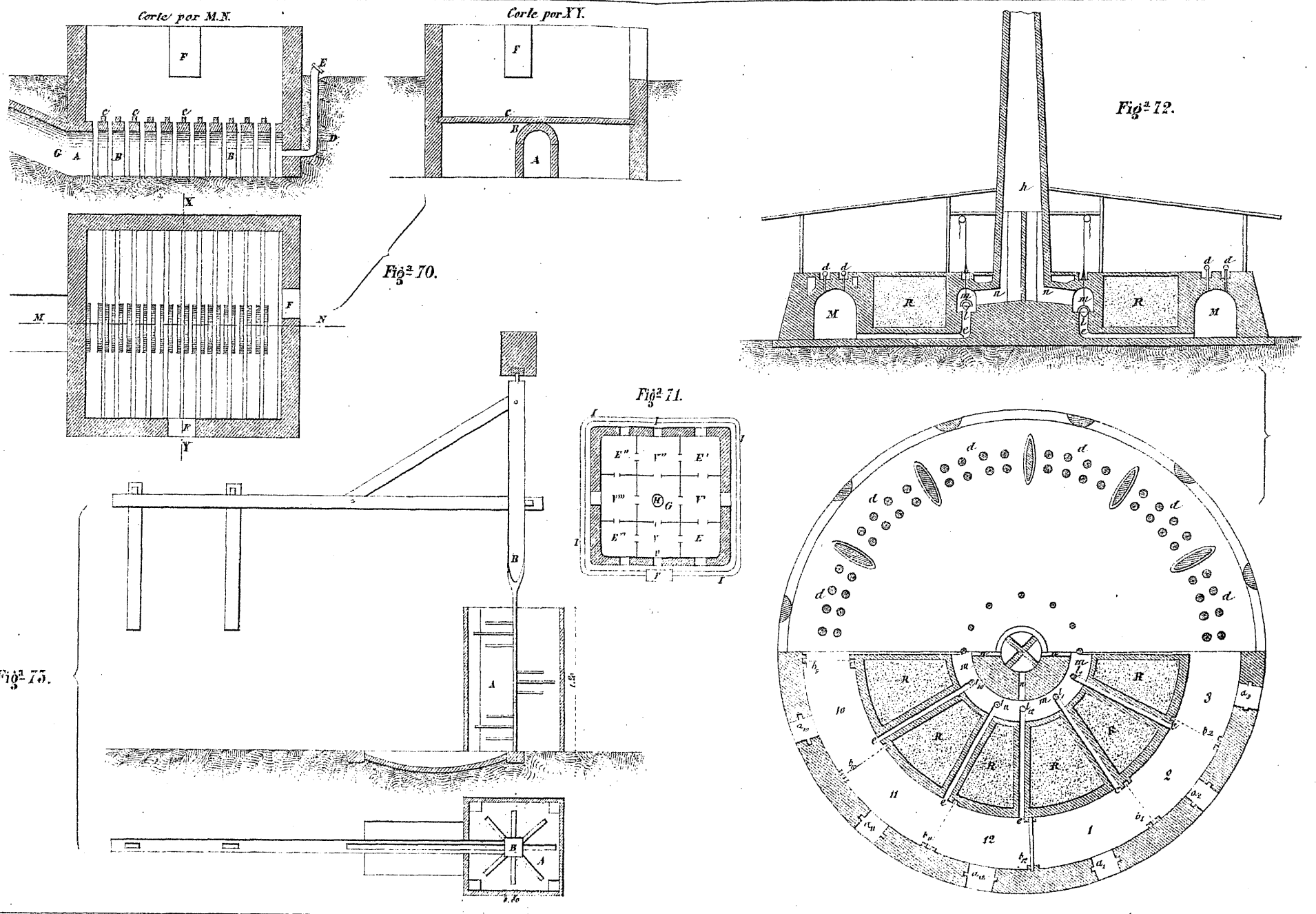

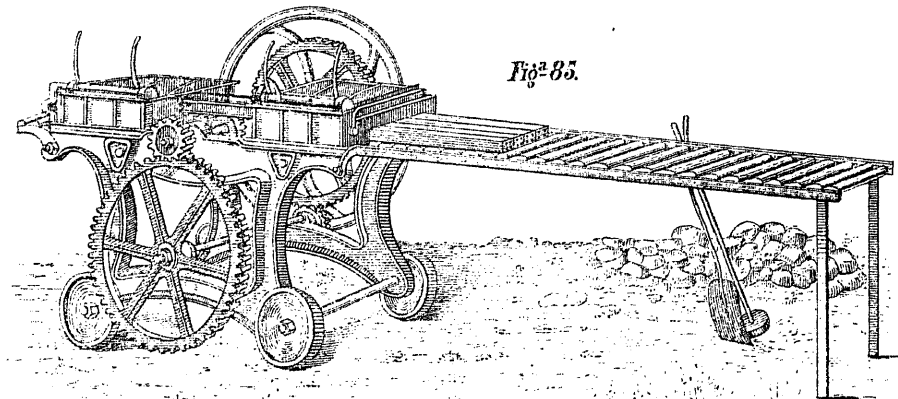
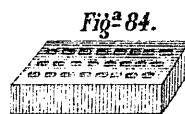
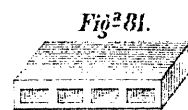
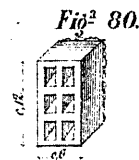
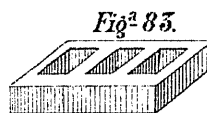
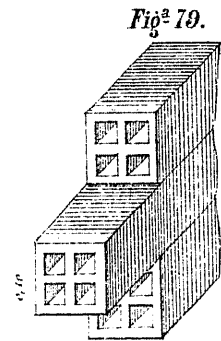
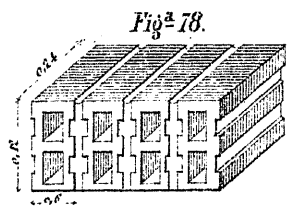
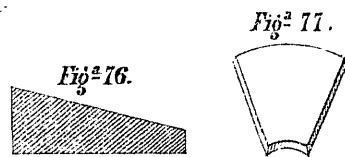
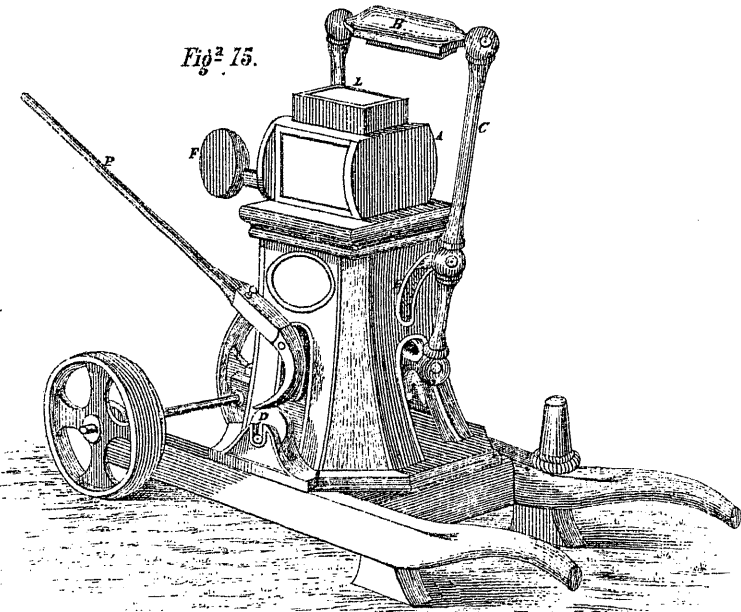
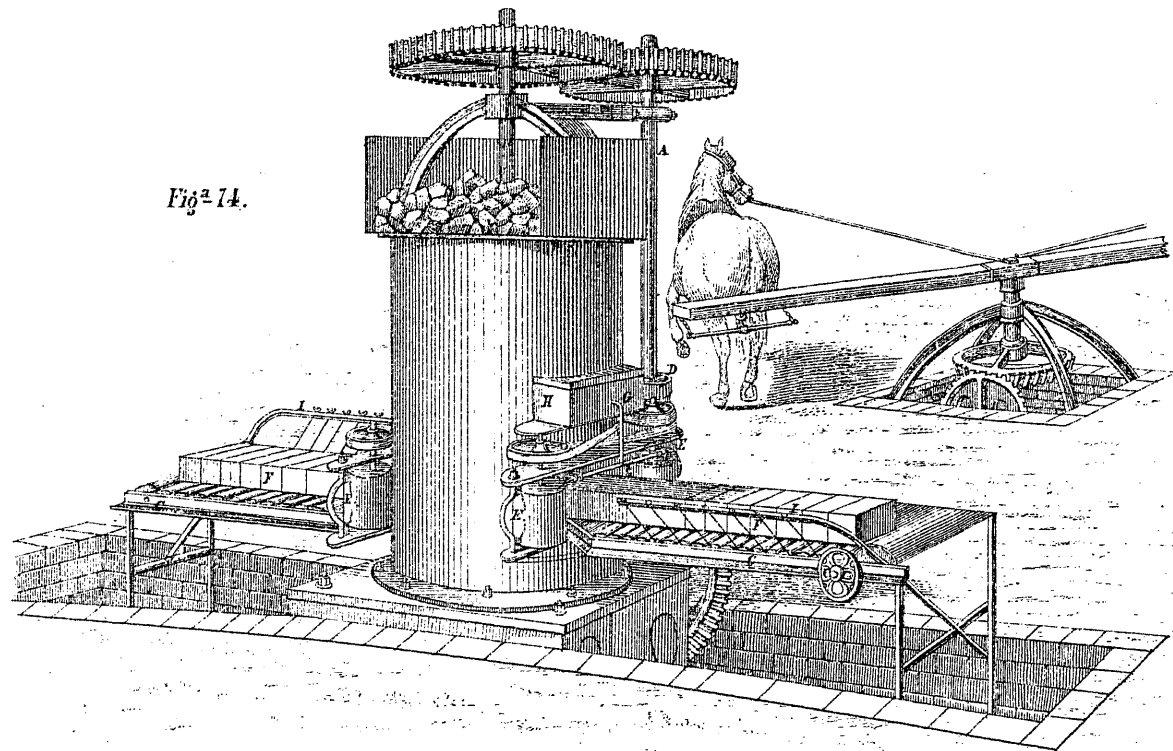

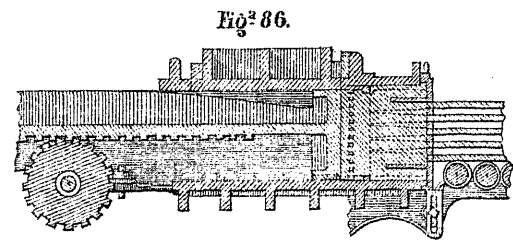

Fig. 86.

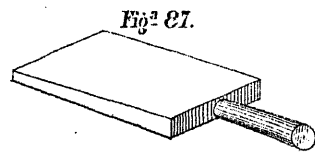

Fig. 87.

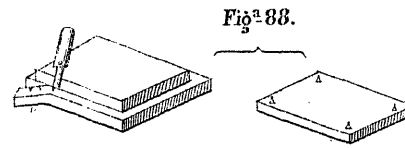

Fig. 88.



Fig. 89.

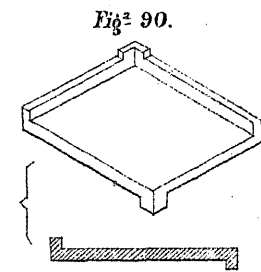

Fig. 90.

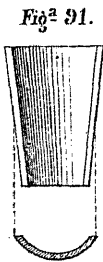

Fig. 91.

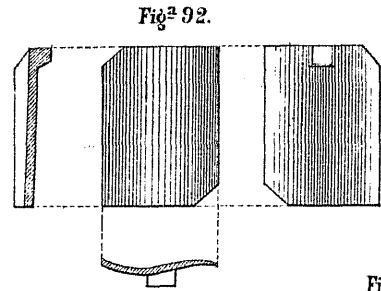

Fig. 92.

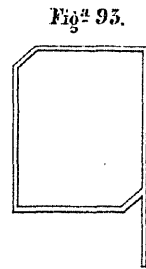

Fig. 93.

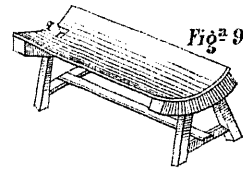

Fig. 94.

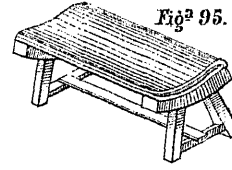

Fig. 95.

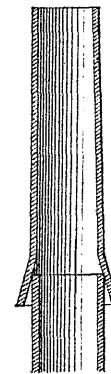

Fig. 101.

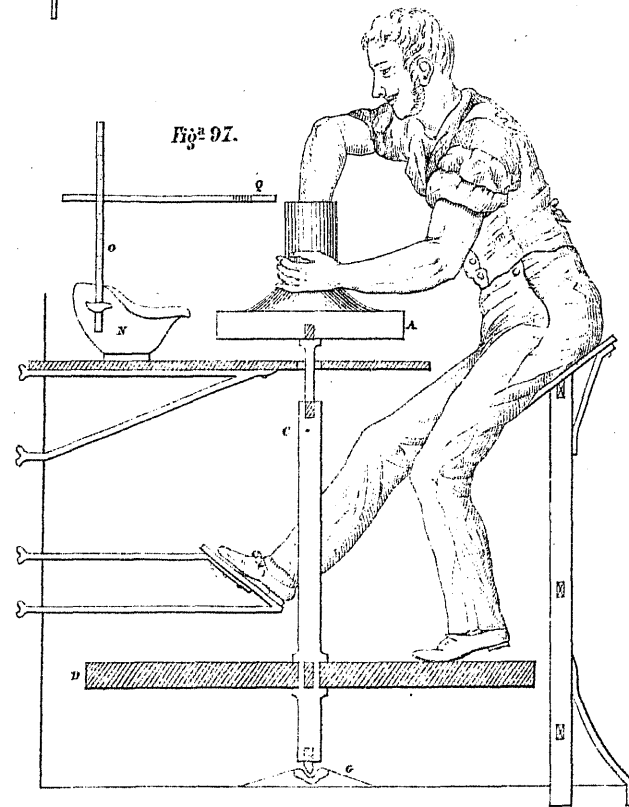

Fig. 97.

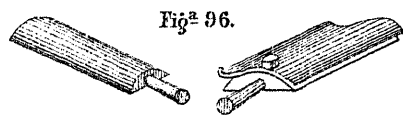

Fig. 96.

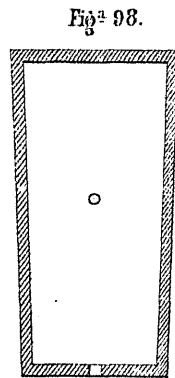

Fig. 98.

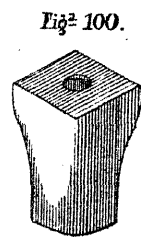

Fig. 100.

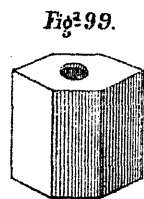

Fig. 99.

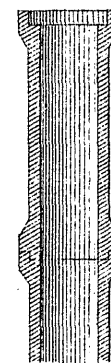

Fig. 102.

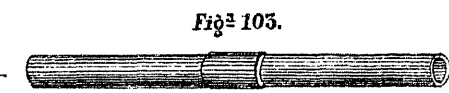
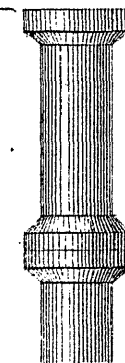

Fig. 103.

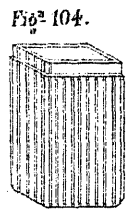

Fig. 104.

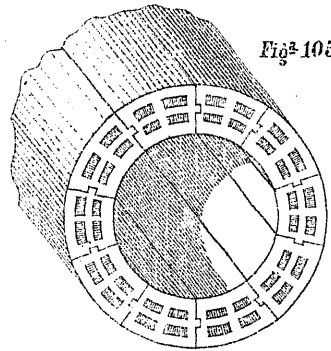

Fig. 105.



Fig. 106.



Fig. 107.

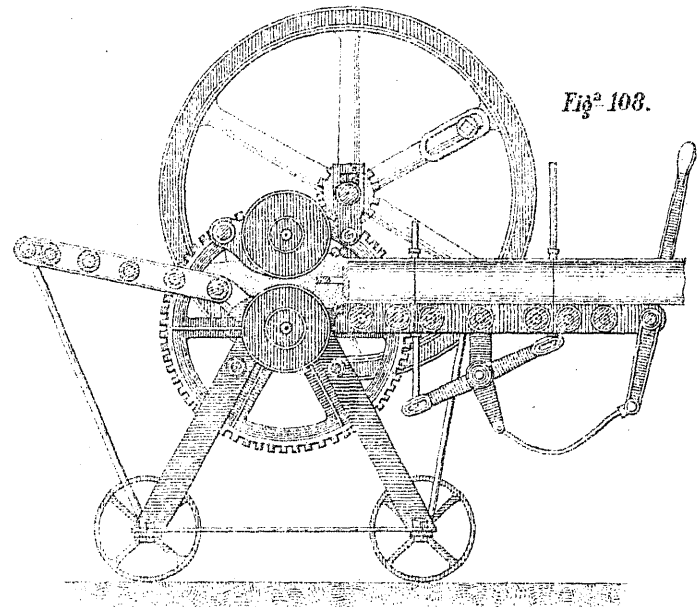

Fig. 108.

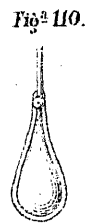

Fig. 110.

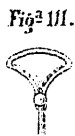

Fig. 111.

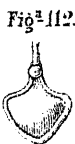

Fig. 112.



Fig. 113.



Fig. 114.



Fig. 115.



Fig. 116.

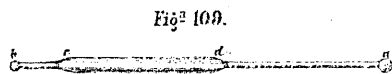

Fig. 109.

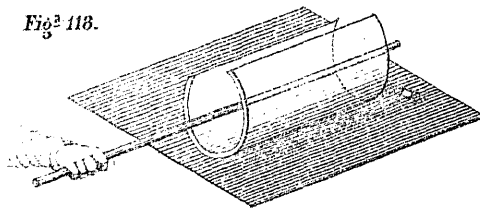

Fig. 118.

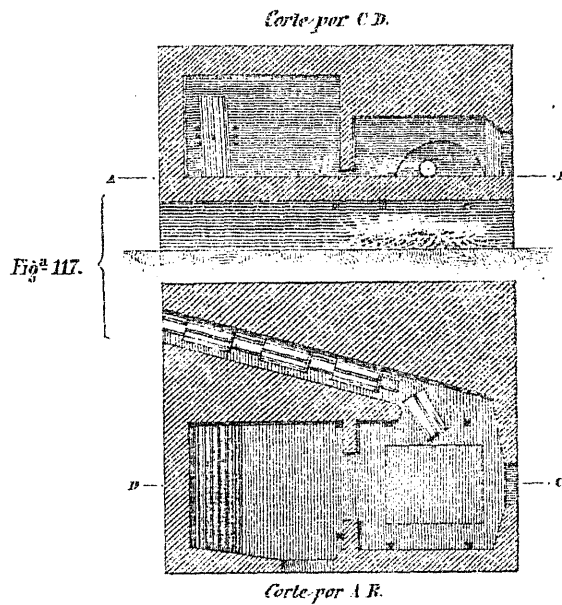

Fig. 117.



Fig. 119.

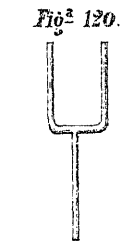
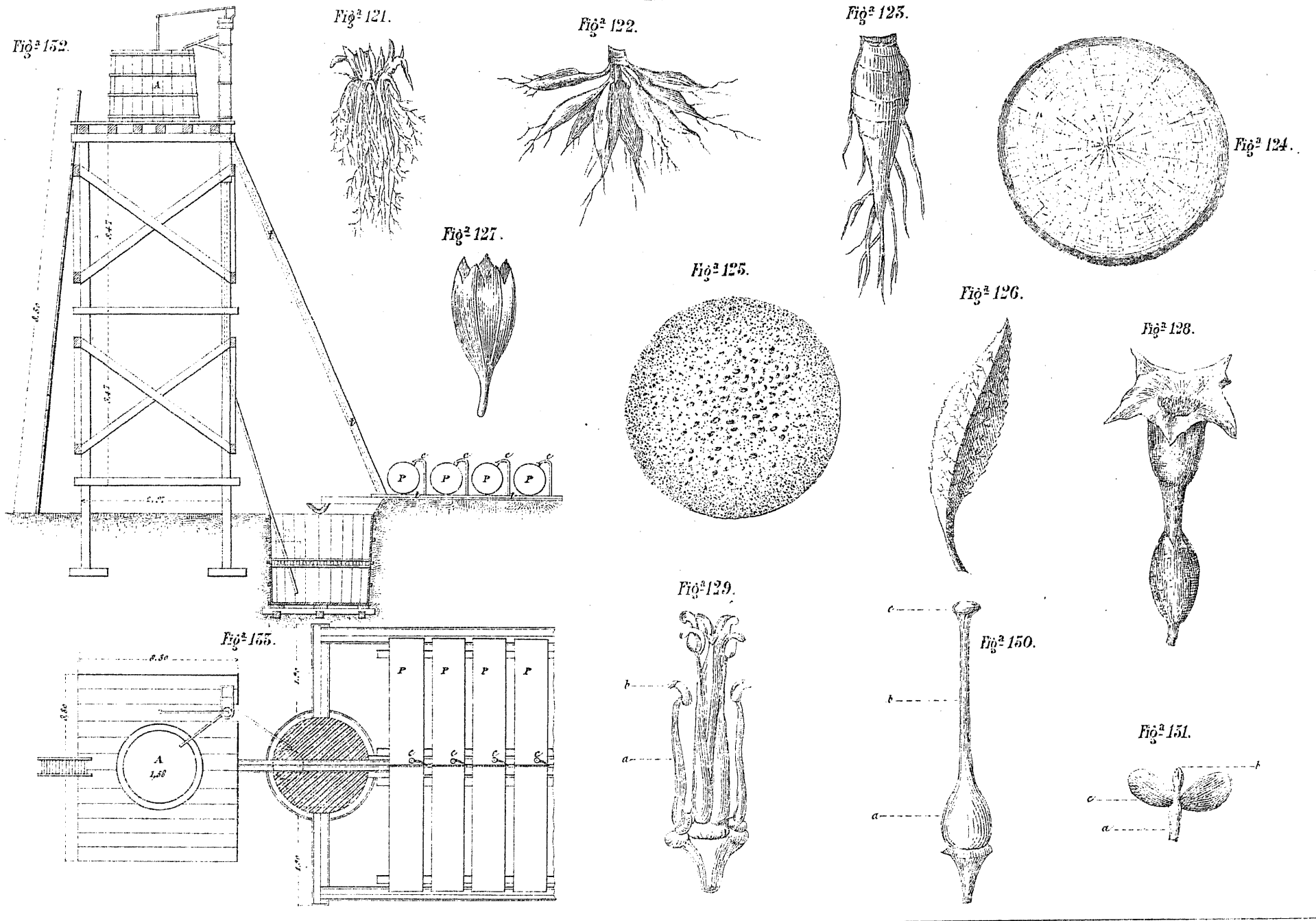
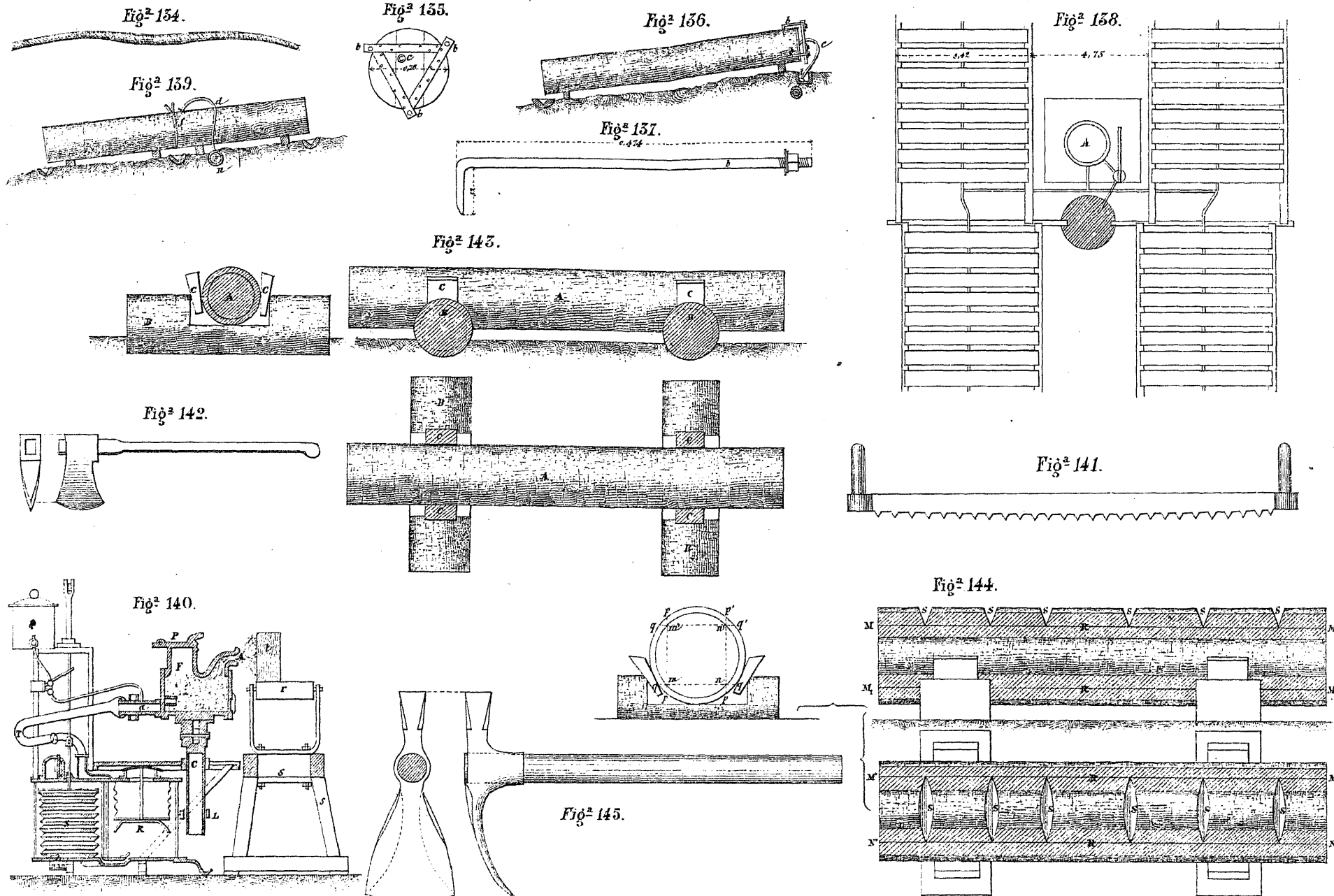
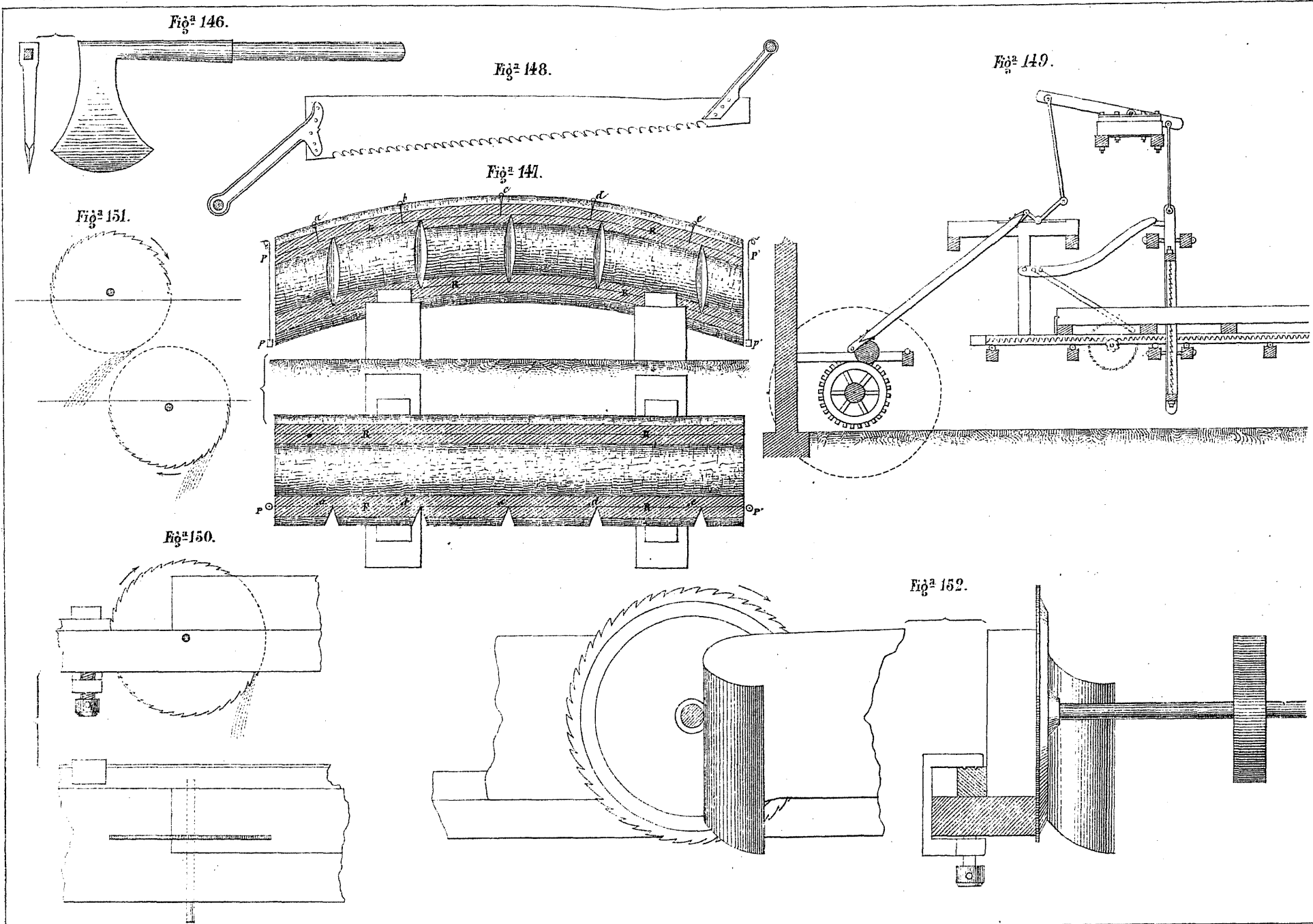
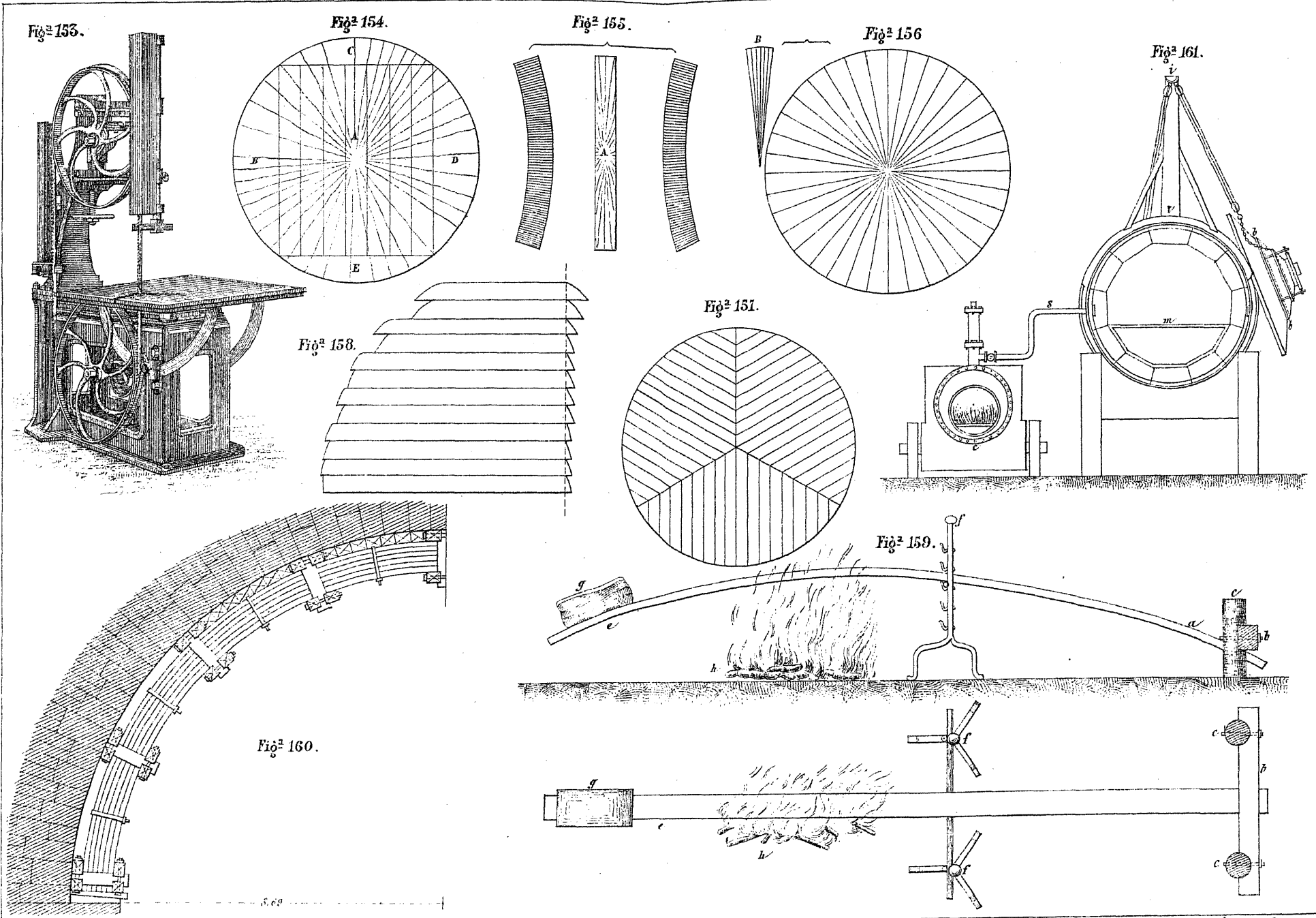

Fig. 120.









J. Navarro d^o

Lit. E. Fernandez Fejos & Madrid.

A. Corona g^o

Fig^a 171.

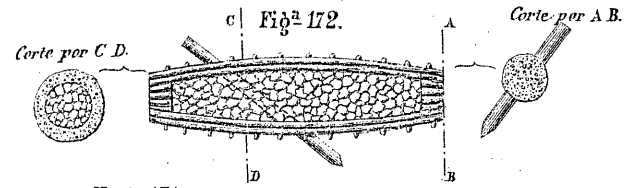
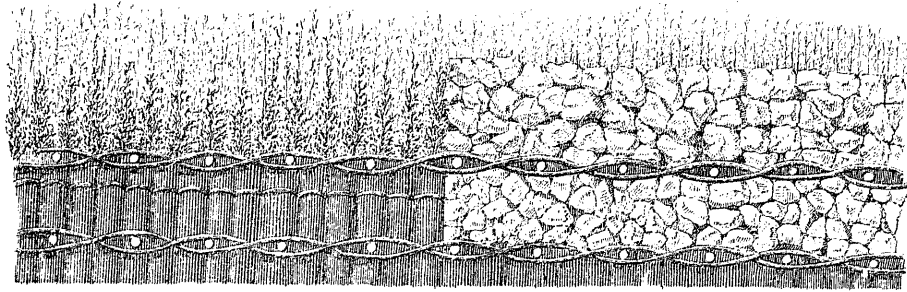

Fig^a 175.

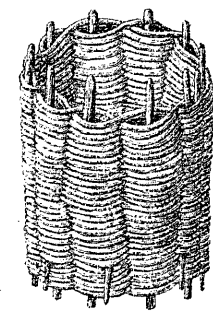

Fig^a 174.

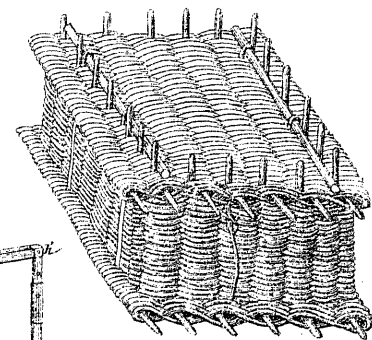

Fig^a 176.



Fig^a 175.

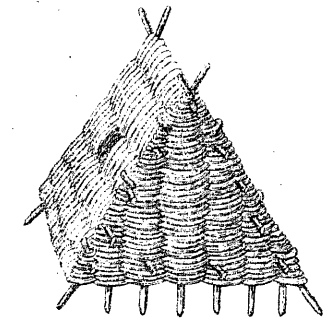

Fig^a 177.

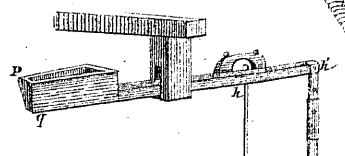
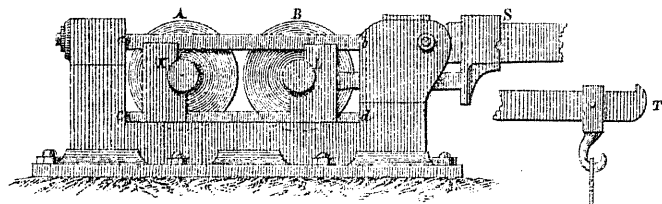

Fig^a 179.

Fig^a 178.

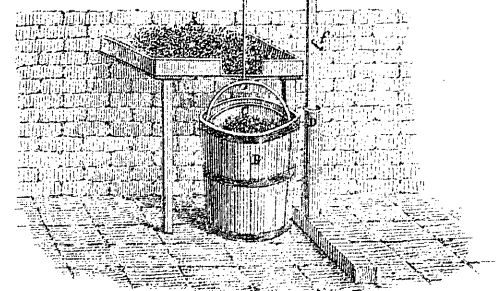
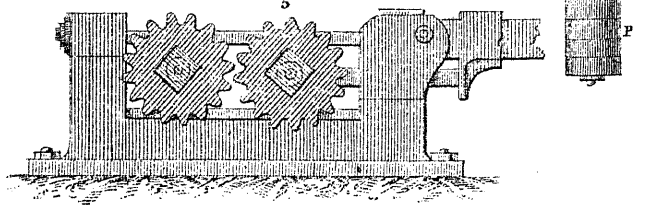

Fig^a 180.

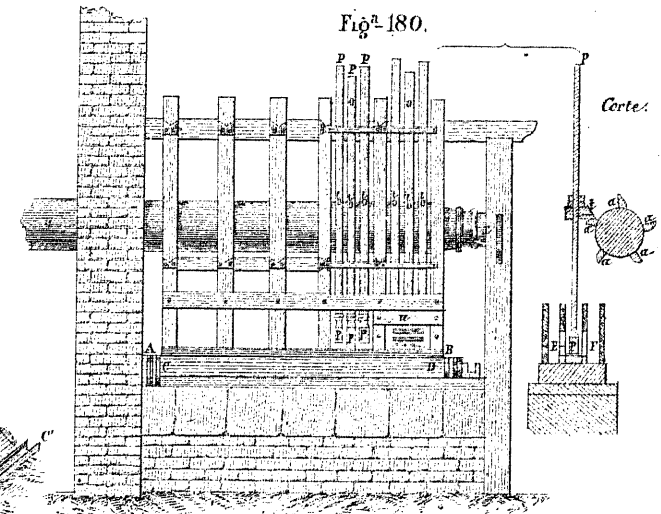

Fig^a 181.

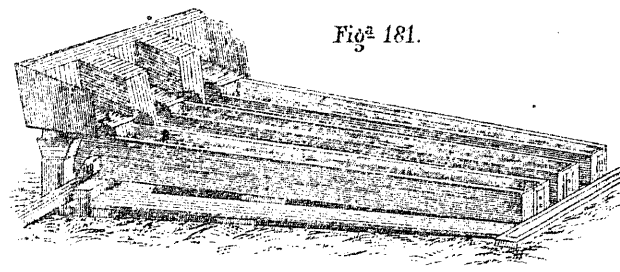

Fig^a 182.

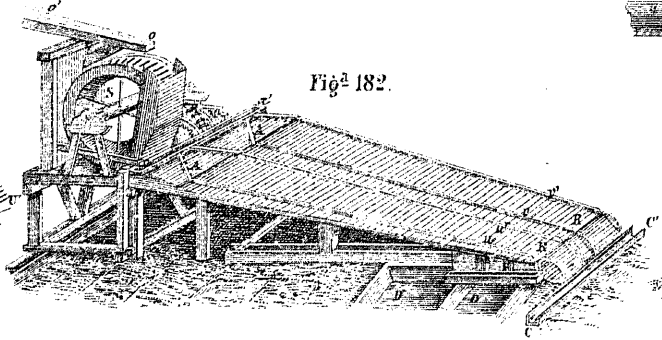

Fig^a 185.

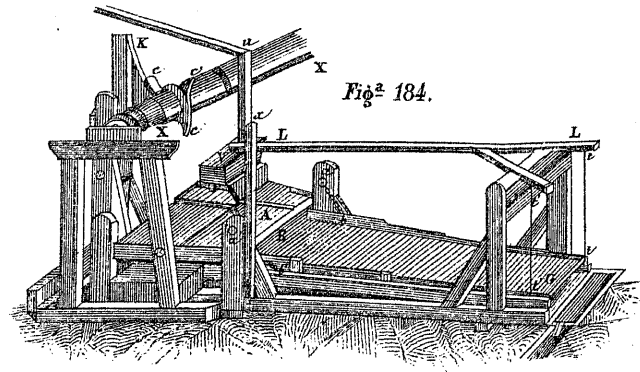
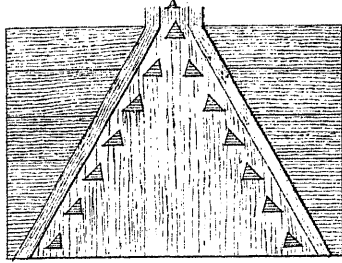

Fig^a 184.

Fig^a 185.

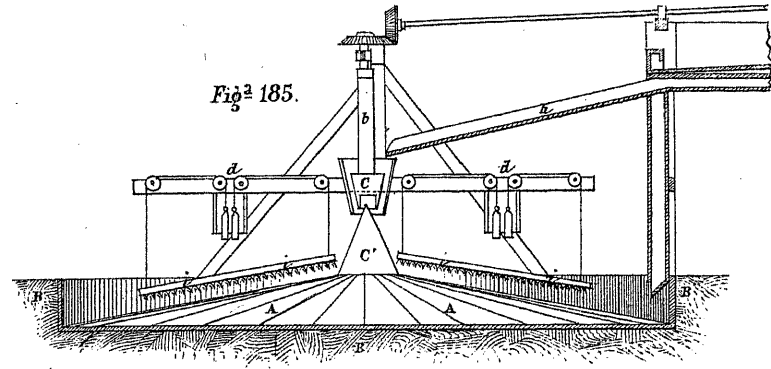

Fig^a 186.

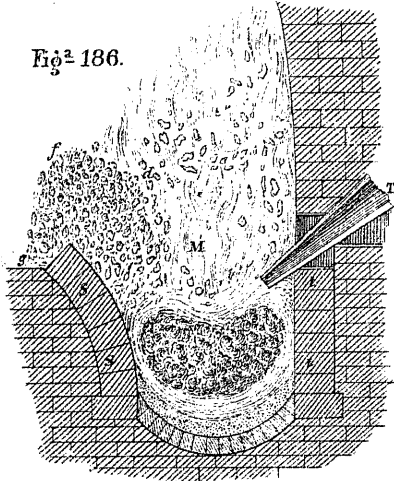

Fig^a 187.

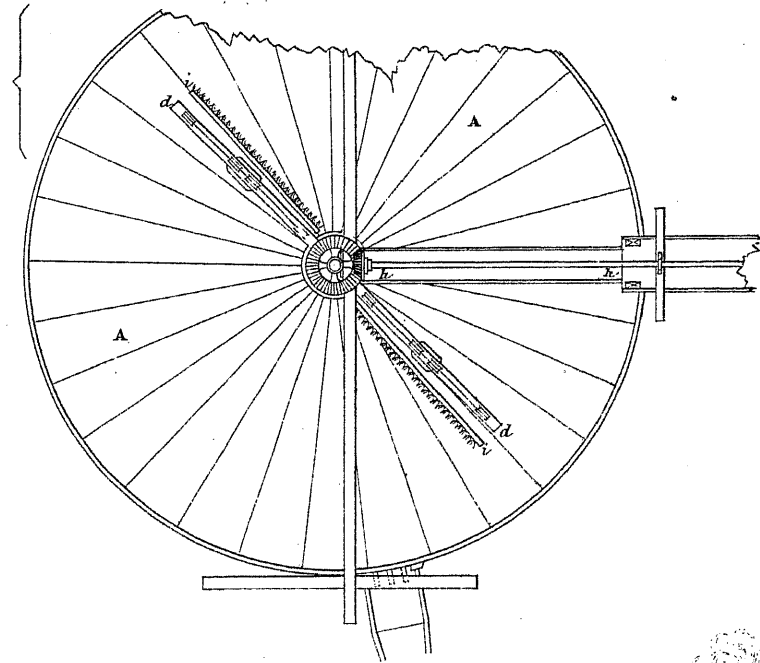
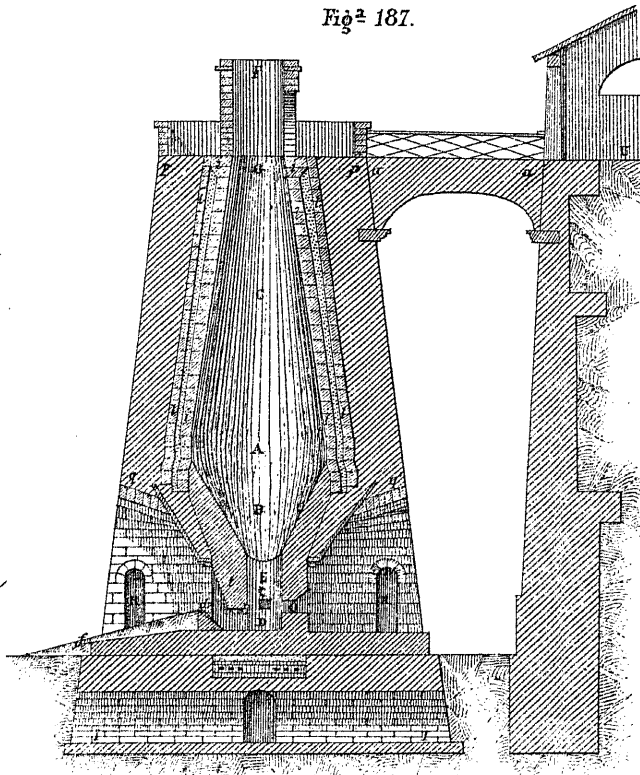

Fig^a 188.

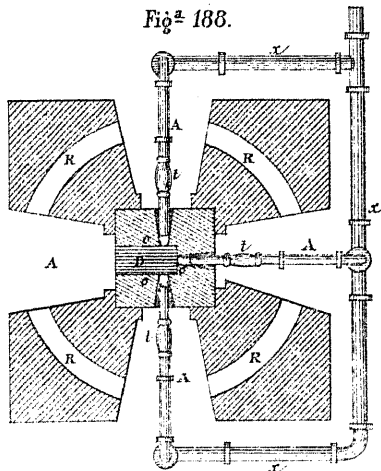

Fig^a 189.

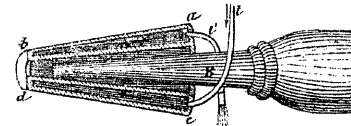

Fig^a 190.

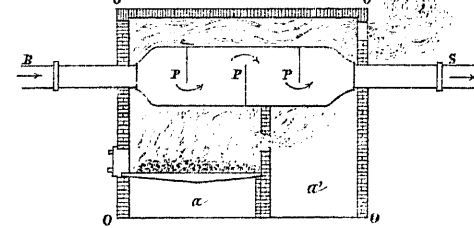

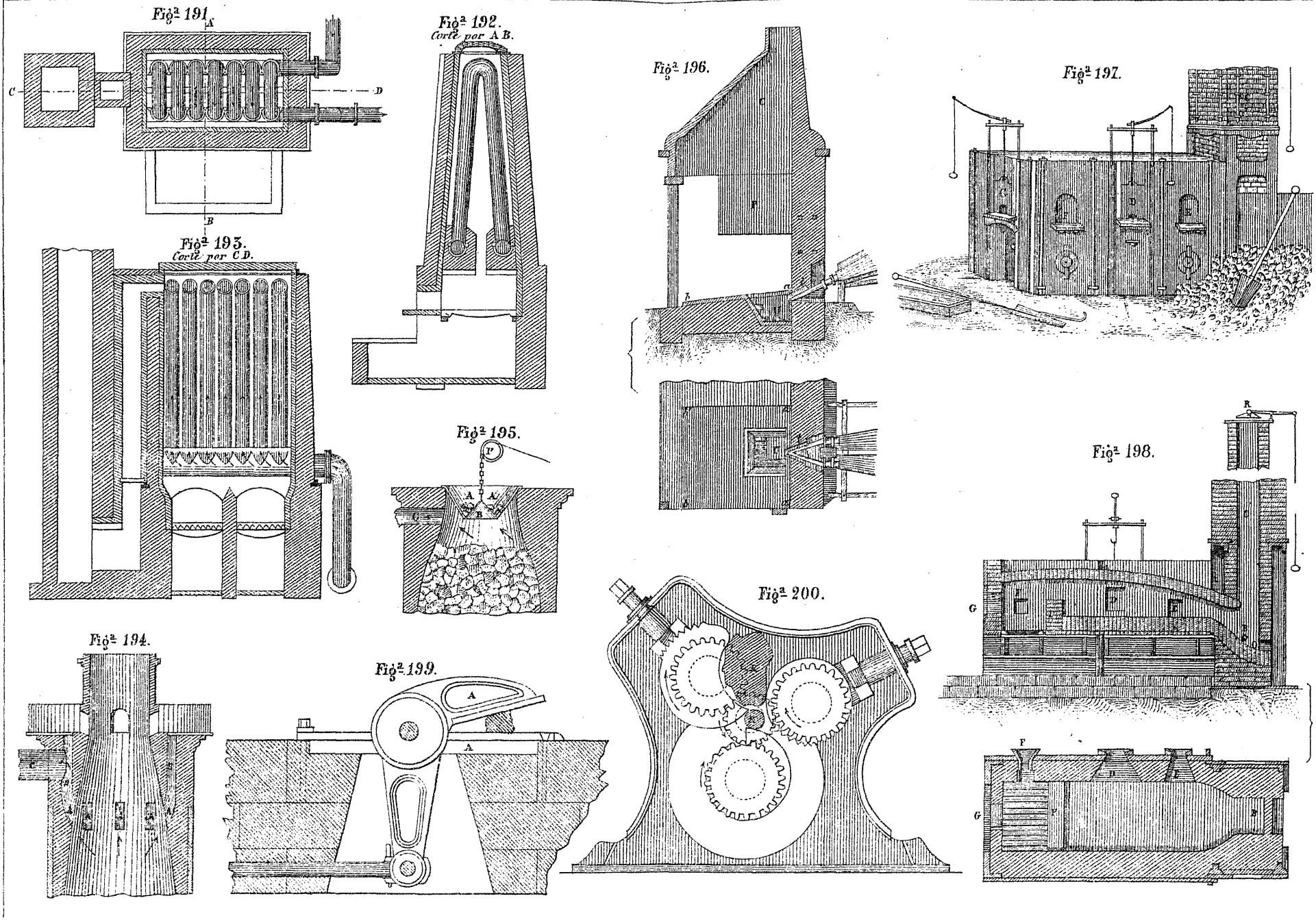

J. Navarro d^o

lit. E. Fernandez, Fejes 8, Madrid.

A. Correas g^o

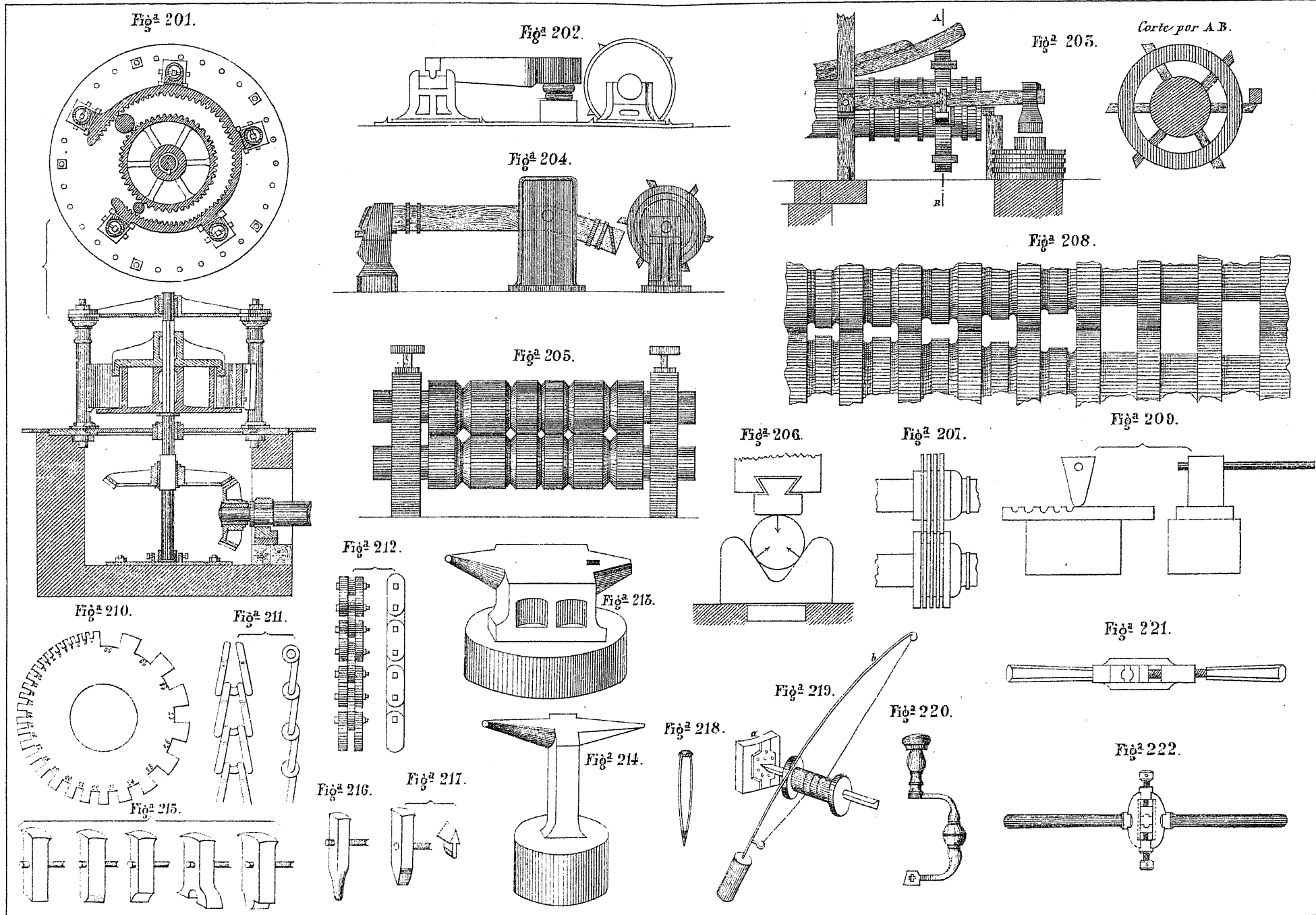

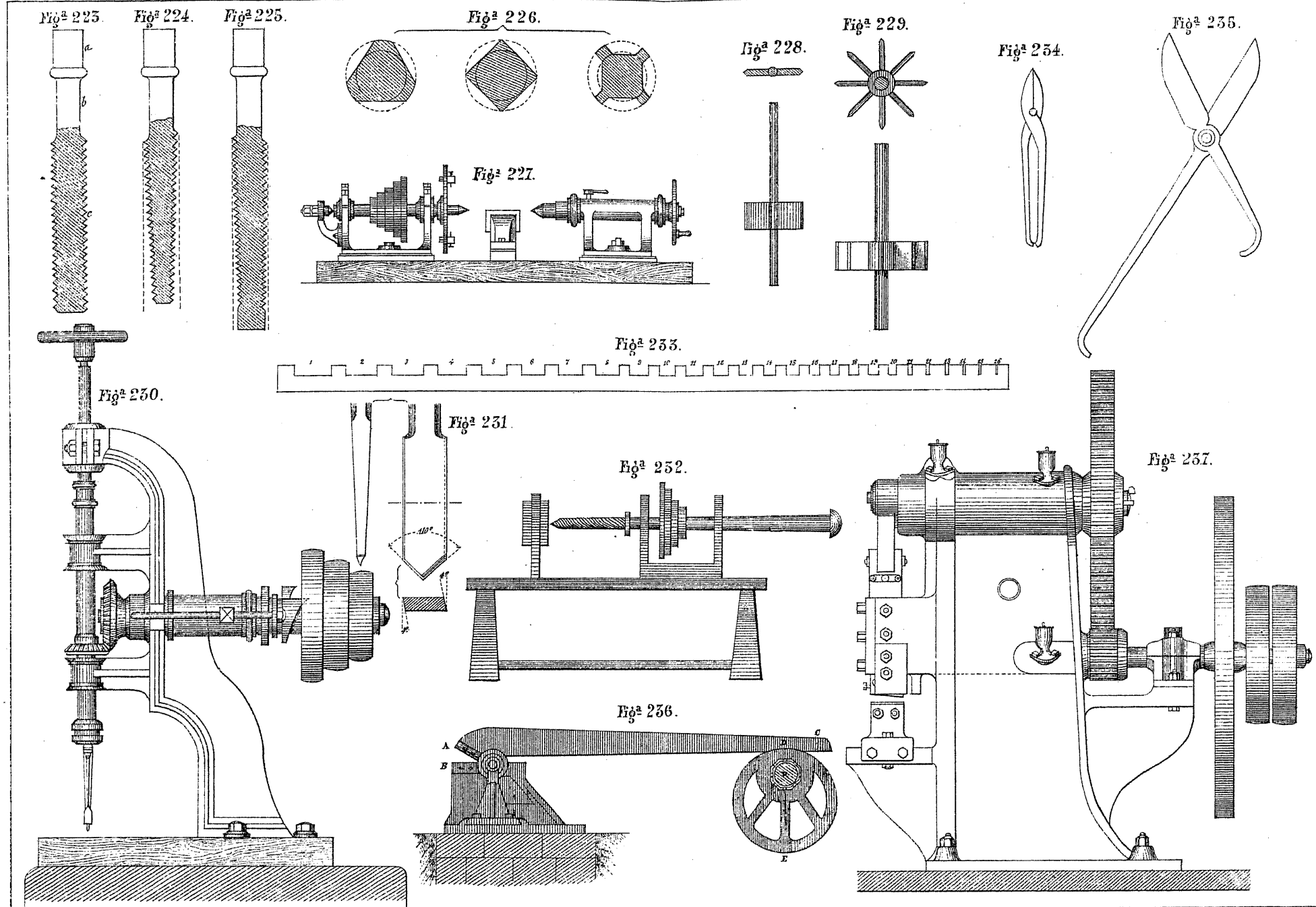

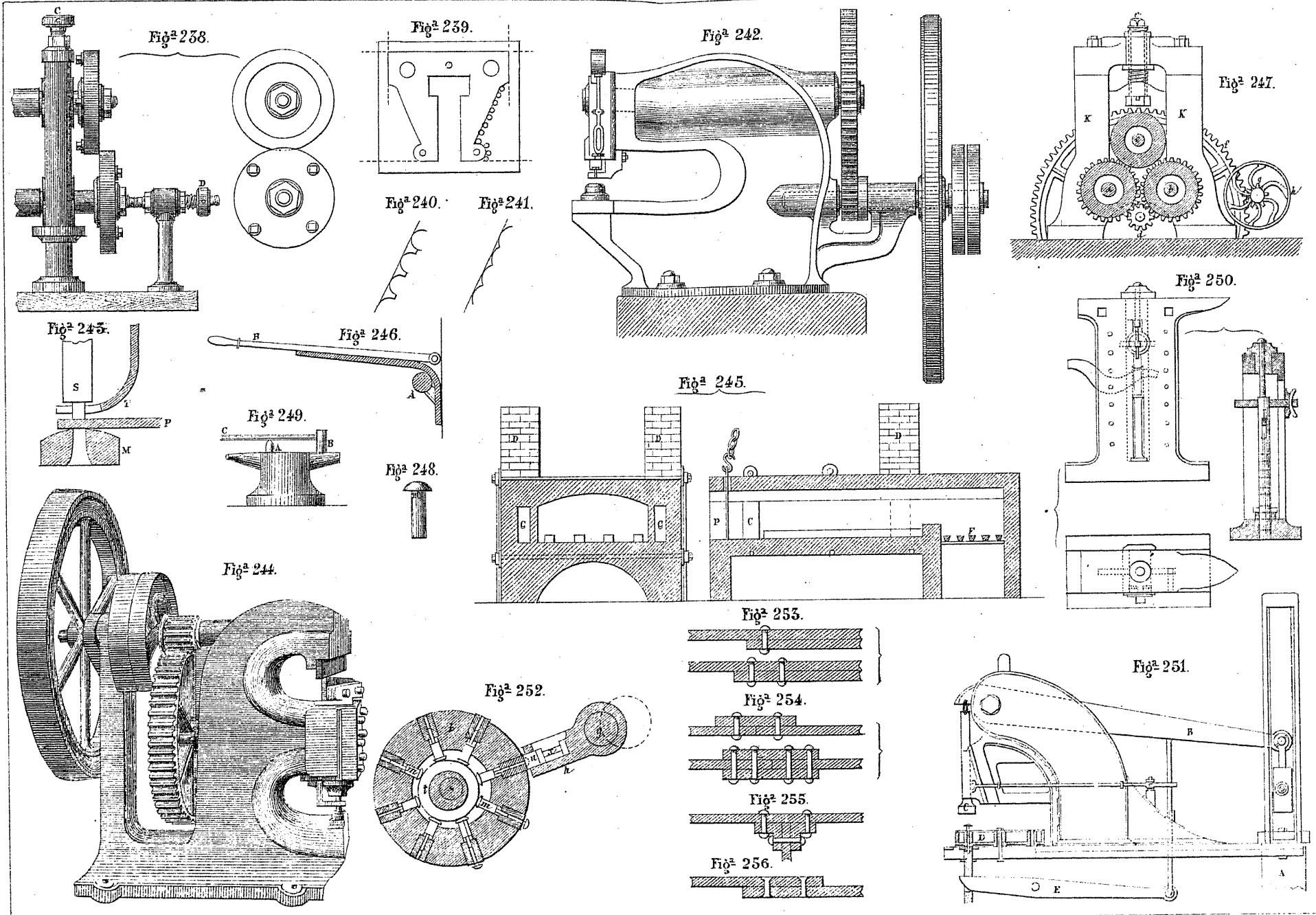

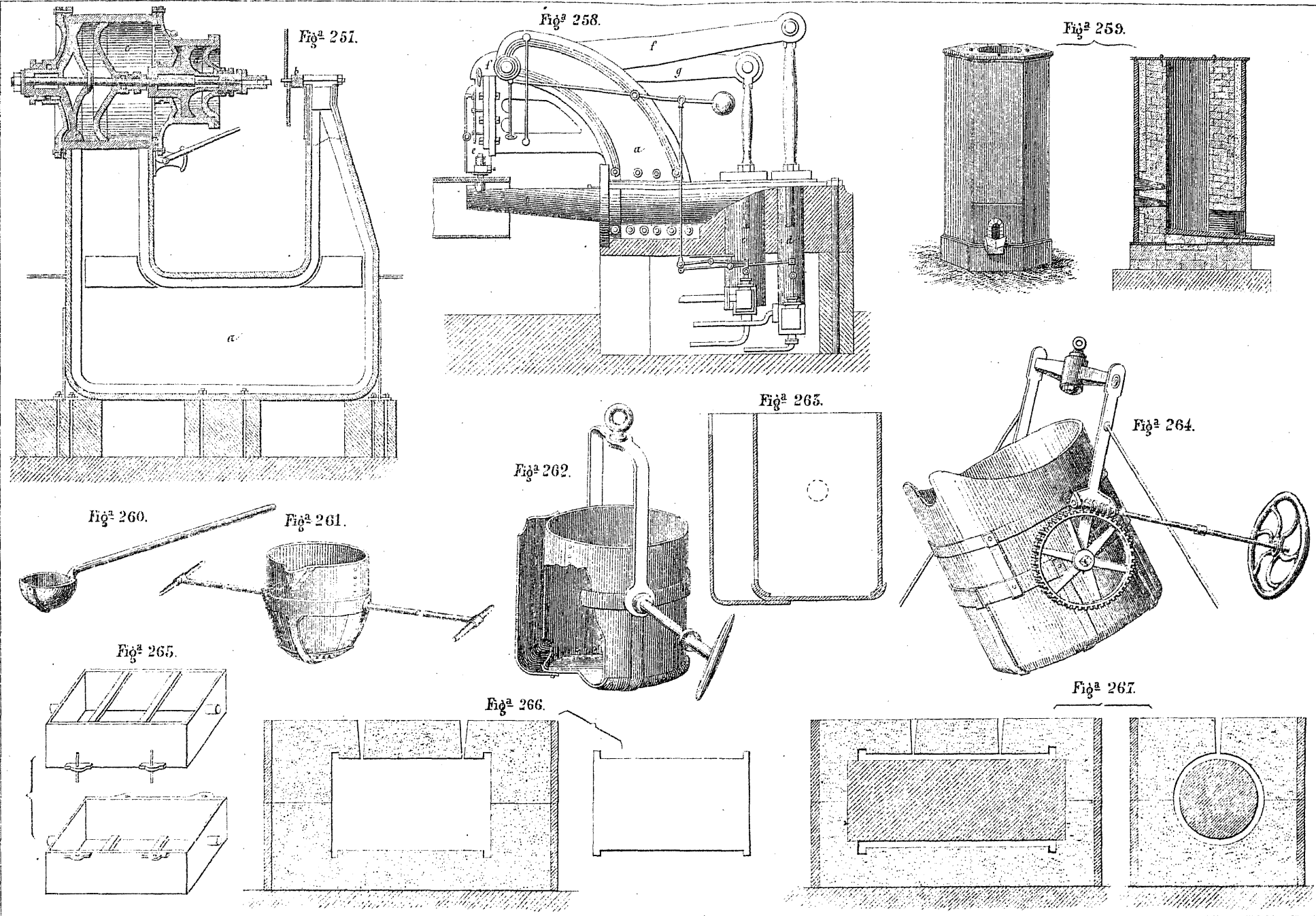

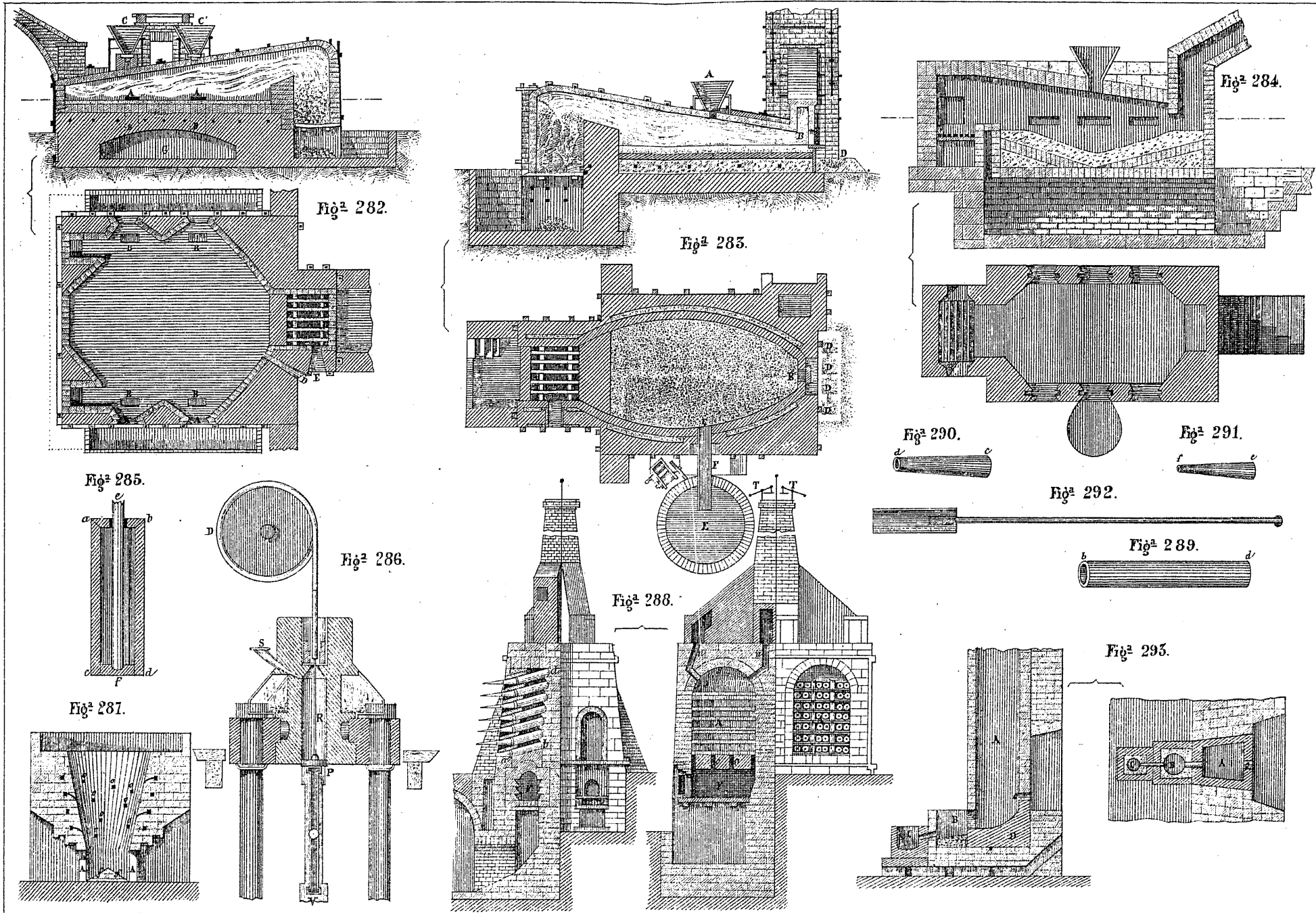

J. Navarro d.^o

Lit. E. Fernandez, Fajos 3, Madrid.

A. Corona g.^o

Fig^a 294.

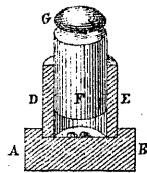

Fig^a 295.

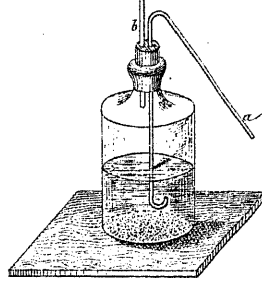

Fig^a 296.

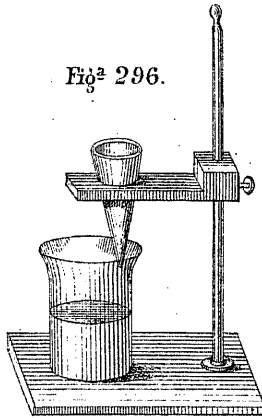

Fig^a 298.

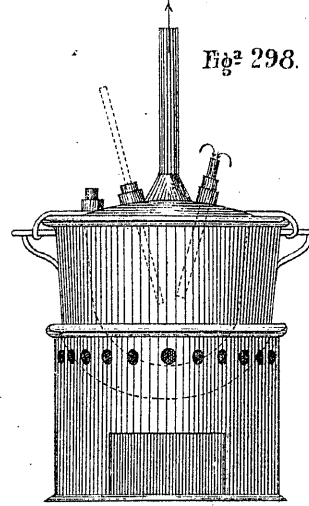

Fig^a 299.

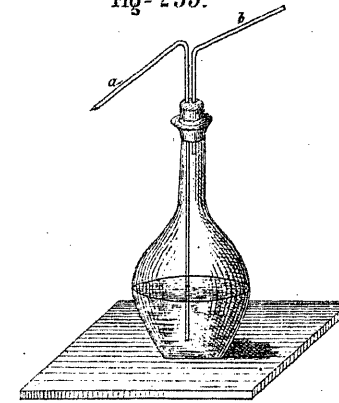

Fig^a 297.

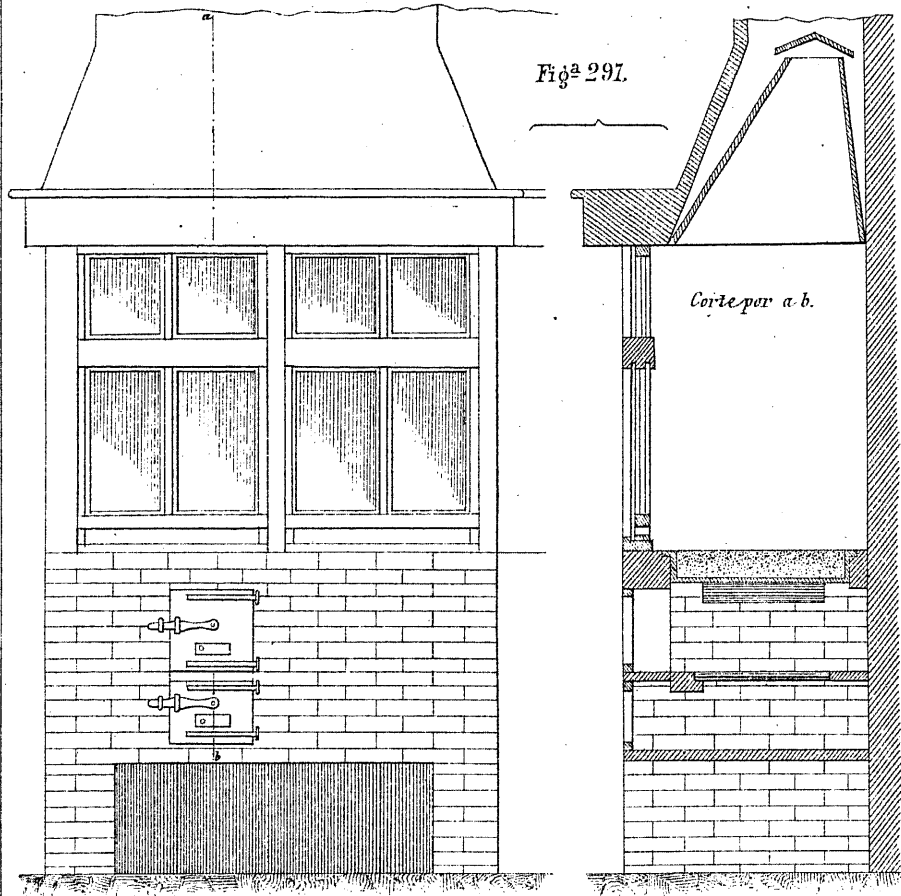

Fig^a 300.

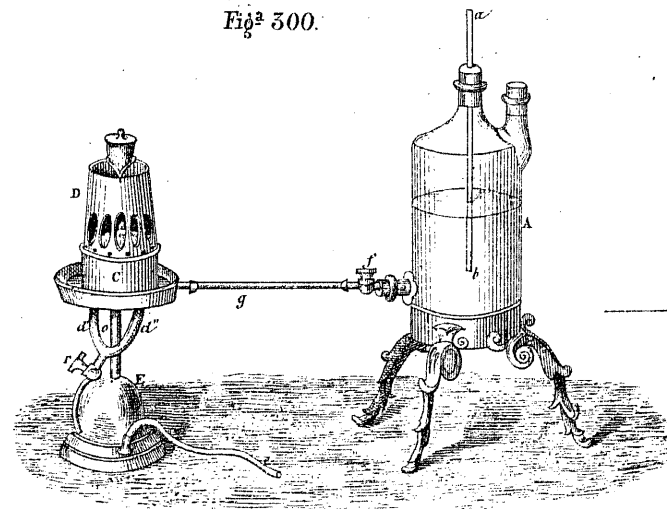

Fig^a 301.

